

**INSTRUCTION MANUAL
MANUAL DE INSTRUCCIONES
MANUEL D'UTILISATION
BEDIENUNGSANLEITUNG
MANUALE DI ISTRUZIONI
MANUAL DE INSTRUÇÕES
РУКОВОДСТВО ПОЛЬЗОВАТЕЛЯ**

**WASHING MACHINES
LAVADORAS
LAVA-LINGE
WASCHMASCHINEN
LAVATRICI
MÁQUINAS DE LAVAR ROUPA
СТИРАЛЬНЫЕ МАШИНЫ**

LAP-08 / LAP-10
LA-11 / LA-14 / LA-18 / LA-25 / LA-35
LA-45 / LA-60 / LA-120
LR-11 / LR-14 / LR-18 / LR-25 / LR-35
LN-11 / LN-14 / LN-18 / LN-25 / LN-35 / LN-60

LAP-0820 / LAP-1025
FWH-25 / FWH -30 / FWH -40 / FWH -60 / FWH -80
FWH -100 / FWH -135 / FWH -275
FWR-25 / FWR -30 / FWR -40 / FWR -60 / WFR -80
FWS -25 / FWS -30 / FWS -40 / FWS -60 / FWS -80 / FWS -135





Bº Santxolopetegi, 22 Aptdo 17
20560 Oñati, (Gipuzkoa / Spain)
T. + 34 943 71 80 30

www.fagorindustrial.com

INTRODUCTION

Dear customer,

Thank you for the confidence you have placed in our product. We hope it meets your needs.

The guarantee does not cover damage to glass components, or consumables (seals, bulbs, etc.) nor damage to insulation material or damage due to the incorrect installation of the appliance, or to inappropriate use, inadequate maintenance or poor repair processes.

This appliance is subject to changes and modifications for its technical progress.

INTRODUCCIÓN

Estimado cliente:

Gracias por haber depositado su confianza en nuestro producto. Deseamos que responda a sus necesidades.

Las condiciones de garantía no cubren daños de componentes de cristal, ni repuestos consumibles (juntas, bombillas, etc.) como tampoco el deterioro del material aislante o daños imputables a una instalación incorrecta del aparato, a su utilización en una aplicación indebida, a un mantenimiento inadecuado o a procesos de reparación deficientes.

Este aparato está sujeto a cambios y modificaciones que apoyen su progreso técnico.

INTRODUCTION

Cher client,

Merci d'avoir fait confiance à notre produit. Nous espérons qu'il répondra à vos besoins.

Les conditions de garantie ne couvrent pas les dégâts de composants en verre, ni le remplacement de consommables (joints, ampoules, etc.), de même que les détériorations sur le matériau isolant ou les dégâts imputables à une installation incorrecte de l'appareil, à son utilisation incorrecte, à un entretien inadapté ou à des réparations erronées.

Cet appareil est soumis à des modifications visant son amélioration technique.

ENGLISH

ESPAÑOL

FRANÇAIS

DEUTSCH

ITALIANO

PORTUGUÊS

Русский

EINLEITUNG

Sehr geehrter Kunde,

vielen Dank für das in unser Produkt gesetzte Vertrauen. Wir hoffen, dass dieses Ihren Vorstellungen voll und ganz gerecht wird.

Die Garantiebestimmungen decken keine Schäden an Bauteilen aus Glas oder an Verschleißteilen (Dichtungen, Glühbirnen, usw.) oder Beschädigungen des Isoliermaterials, sowie auf eine nicht ordnungsgemäße Installation des Gerätes, unsachgemäßen Gebrauch oder mangelhafte Reparaturen zurückzuführende Schäden.

Das Gerät unterliegt Änderungen und Modifizierungen im Sinne des technischen Fortschritts.

INTRODUZIONE

Gentile Cliente,

La ringraziamo per aver scelto il nostro prodotto. Ci auguriamo che risponda alle sue esigenze.

Le condizioni di garanzia non coprono i danni ai componenti di vetro, i ricambi consumabili (guarnizioni, lampadine, ecc.) così come l'usura del materiale isolante o i danni provocati da un montaggio scorretto dell'apparecchio, dall'uso in un'applicazione erronea, dalla manutenzione inadeguata o da procedure di riparazione insufficienti.

Il presente apparecchio, è soggetto a cambi e modifiche che permettono il progresso tecnico.

INTRODUÇÃO

Caro cliente:

Obrigado por ter depositado a sua confiança no nosso produto. Desejamos que corresponda às suas necessidades.

As condições de garantia não cobrem danos de componentes de vidro, nem consumíveis (juntas, bombas, etc.), tal como não cobrem o desgaste do material isolante nem os danos devidos a uma instalação incorrecta do aparelho, à sua utilização numa aplicação indevida, a uma manutenção inadequada ou a processos de reparação deficientes.

Este aparelho está sujeito a alterações e modificações que suportem o seu progresso técnico.

Введение

Уважаемый Клиент:

Благодарим вас за оказанное доверие нашему оборудованию. Надеемся, что оно удовлетворит все ваши требования.

Условия гарантии не распространяются на стеклянные элементы и расходные запасные части, а также на изолирующие компоненты и на повреждения, вызванные неправильной установкой, обслуживанием или использованием.

Данный аппарат будет подвергаться дальнейшим изменениям и улучшениям для развития модельного ряда.

- SAFETY INSTRUCTIONS 2**
- 1 USE..... 5**
 - 1.1 Recommendations for use 5
 - 1.2 Using the dispenser..... 5
 - 1.3 Machine features..... 5
- 2 INTERFACE..... 6**
 - 2.1 Screen OFF OPL 6
 - 2.2 Main Screen OPL 6
 - 2.3 Run screen OPL 7
- 3 PROGRAMMES..... 10**
 - 3.1 Cycle parameters 10
 - 3.1.1 Parameters for soak, prewash, wash or rinse cycles: 10
 - 3.1.2 Parameters for spin cycles:..... 12
 - 3.2 Cycle library 13
 - 3.3 Programme library 15
- 4 CONFIGURATION..... 16**
 - 4.1 Programme management 17
 - 4.1.1 My programmes (favourites). 17
 - 4.1.2 Programme library 18
 - 4.1.3 Cycle library 21
 - 4.2 Configure System 22
 - 4.2.1 HUD configuration..... 26
- 5 MAINTENANCE..... 30**
 - 5.1 Electrical and mechanical irregularities..... 30
 - 5.2 Warnings..... 30

SAFETY INSTRUCTIONS

In order to reduce the risk of electrical shocks or injury when using the appliance, the basic precautions should be observed, including the following:

- **READ** all the instructions prior to using the appliance and **KEEP THEM** in an easily accessible place for reference in the event of doubt.
- Do **NOT** wash clothes which have been previously treated, washed, soaked or stained with petrol, dry cleaning solvents, or other inflammable or explosive substances, as these give off vapours which may catch fire or explode.
- Do **NOT** add petrol, dry cleaning solvents or other inflammable substances to the washing water. These substances give off vapours which could catch fire or explode.
- In some conditions, hydrogen gas may be produced in a hot water system which has not been used for more than two weeks. Hydrogen gas is explosive. If the hot water system has not been used for a while, before using the washing machine turn on all the hot water taps and let the water run for a few minutes. This will release any accumulated hydrogen gas. As the gas is inflammable, do not smoke or use naked flames during this operation.
- This appliance can be used by children aged 8 years or over and persons with reduced physical, sensory or mental capacities or lack of experience or knowledge, provided they have received appropriate supervision or training on the safe use of the appliance and they understand the risks involved. Unsupervised children should not perform the cleaning or maintenance tasks.

- Do NOT allow children to play in or on the appliance. Children should be strictly supervised when in the vicinity of a machine which is operating. Children under the age of 3 years should be kept away from the appliance unless under continuous supervision.
- Remove the door from the appliance before disposal or before leaving it out of service.
- DO NOT TRY TO OPEN THE DOOR if the drum is moving.
- Do NOT install or store the appliance in the open.
- Do NOT try to force the controls.
- The new hoses supplied with the appliance should be used. Do not reuse old hoses.
- Do not repair or replace parts of the appliance or carry out any servicing unless recommended to do so in the User Instruction Manual. Make sure that you fully understand the instructions and have the necessary skills to carry out the operations described.
- Do NOT remove any safety device or modify any components in the washing machine. DO NOT INSTALL components not belonging to the machine in the appliance.
- Failure to comply with any of the instructions given in the Instruction Manual may result in personal injury to the user. It is not possible to provide for all possible situations and contingencies with warnings about risk and hazards. Therefore, any person involved in the transportation, installation, use or maintenance of the machine should always employ common sense, caution and care.

- Do NOT use the machine unless all the covers and guards are correctly fitted and secured.
- The distributor (vendor) MUST correctly instruct the user during commissioning.
- Pour the correct doses of detergent, fabric softener and lay into the dispenser drawer, as indicated by the manufacturer. Heed tips concerning the treatment of different materials given by the manufacturers.
- Daily remove any traces of detergent or liquids from the dispenser drawer. Never use powdered or abrasive detergents for cleaning; use only water and soap.
- Clean the water inlet filters and the external dispenser conducts once a month.
- Never clean the exterior by water injection; functional parts of the machine could damage.
- If the washing machine is to be idle for long periods, apply a coat of Vaseline oil to all its stainless steel surfaces.
- An annual general revision is recommended.

1 USE

1.1 Recommendations for use

This machine has been designed to wash or treat most materials. Its use for other purposes than those given is considered as undue and dangerous.

The machine should be loaded with the nominal load, smaller or bigger loads should be avoided.

Clothes should not be washed in sacks or cloth bags. If this is absolutely necessary, make sure the machine is loaded to the nominal load to avoid possible unbalanced loads.





Canvas, waterproof items, mops, carpets or rugs should not be spun.

When a programme ends, before allowing the door to be opened, the clothes are untangled during 30 seconds. An acoustic signal when the door can be opened after this process.

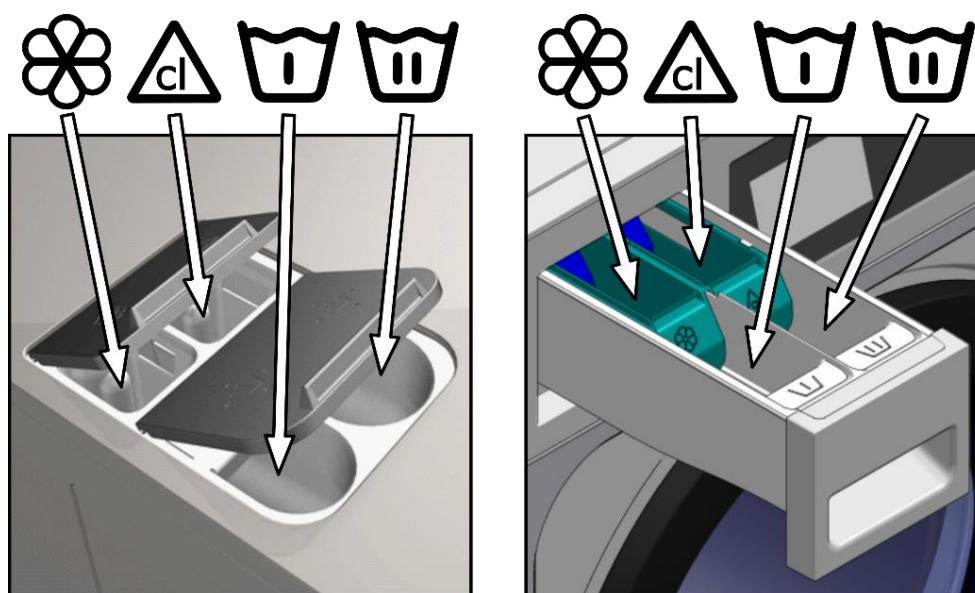
1.2 Using the dispenser

Add washing products to each compartment and close dispenser cover.



-  Powdered detergent for prewash
-  Powdered detergent for wash
-  Liquid softener
-  Liquid whitener (bleach)

1.3 Machine features

The machine is controlled using a microprocessor able to adapt to the needs of each user.

The machine has an intelligent control to control the water temperature; if hot water is available, it should be connected. The machine adjusts the different water inputs to maintain the programmed temperature.

It has intelligent control for spin cycle management. The washing machine controls any unbalanced loads and manages the spin to ensure a good spin, reducing noise and extending the useful life of wearable components, thus significantly reducing fatigue in the mechanic components.

2 INTERFACE

All the washing machines have a touch screen displaying all the information and from where it is possible to select all the controls shown on the screen.

When the machine is switched on, Screen Off is displayed. The ON/OFF button takes the user to the Main screen, from where it is possible to run a programme or go to the main menu. Press START to go to the Run screen, which displays all the relevant information about the screen.

Press ON/OFF to return to Screen Off from the current screen.

The information displayed on each of the screens can be omitted or enabled from the HUD menu (See section 4.2.1).

2.1 Screen OFF OPL

This screen is displayed when the washing machine is switched off, showing the parameters configured by the user.

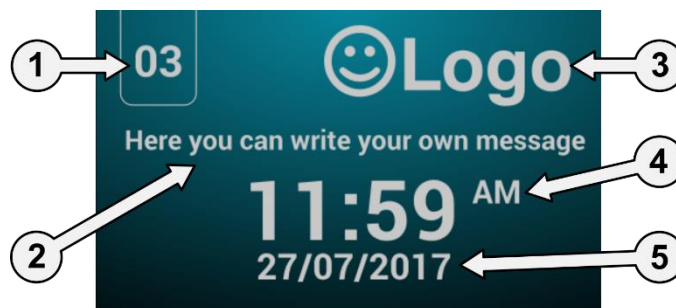

1. **Machine identifier:** Label identifying the machine (if enabled).
2. **Laundrette message:** Message configured by the user (if enabled).
3. **Logo:** The logo is displayed (if enabled).
4. **Time:** Time and minutes in the selected format.
5. **Date:** Date in the selected format (if enabled in HUD).

If the option “energy saving” is active, 10 minutes after switching off the washing machine, the screen backlight will go off. If any part of the screen is touched, the backlight will light up again.

2.2 Main Screen OPL

The Main screen of the washing machine is as follows, and displays each of the available options. Some of the options may be omitted from the HUD menu.



1. **Machine identifier:** Label identifying the machine.
2. **Time:** Time and minutes in the selected format.
3. **Weight of clothes:** The weight of the clothes in the machine is displayed (if the weighing kit is active) or the nominal load for the selected model (if the kit is not active), and the weight of the load entered can be edited. Option to enable/omit in HUD. Once the programme has ended or been aborted, the nominal load of the machine is selected again.
4.  **Main menu:** Access to washing machine main menu, where the different machine parameters can be configured.
5. **Programme name:** Name configured for the selected programme.
6. **Programme temperature:** Maximum temperature of the different cycles of the programme.
7. **Programme number and length:** Position of the programme in the list of programmes (My Programmes), and the estimated length in minutes for the programme selected.
8. **Increase/decrease programme number:** Permits user to scroll up or down the list of selected programmes. As well as using the buttons, the programme can be increased/decreased by pressing directly on the programme information (just above the button).
9. **Start:** Button to start running the selected programme from the cycle indicated.
10. **Programme cycles:** Press the selected programme icon to display the programme cycles and select the cycle you wish to start with.
In addition, it is possible to configure a programme instantly, that is, change the parameters of a cycle (time, temperature, level and dosage) for the current programme. These values are not saved for future programme runs.

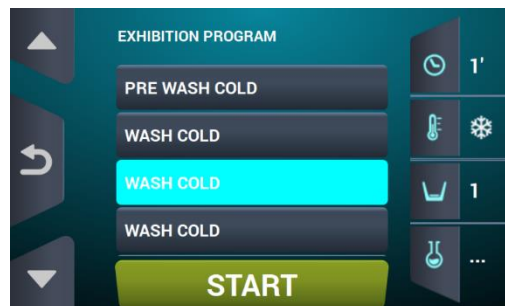





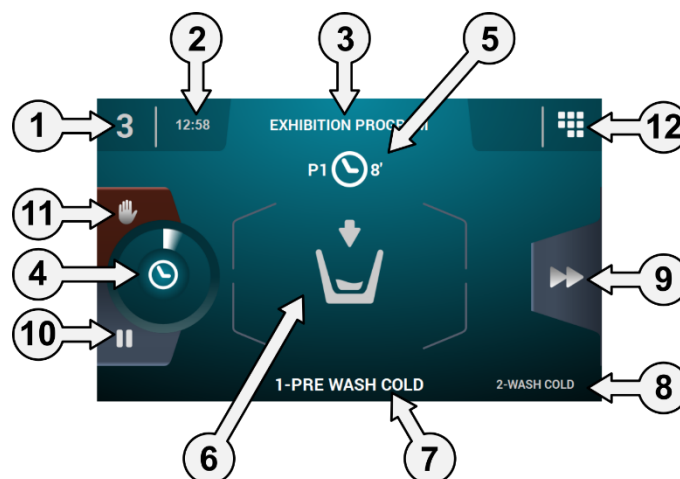









2.3 Run screen OPL

When START is pressed, the programme begins and all the relevant programme information is displayed on this screen. Some of the options may be omitted from the HUD menu.





1. **Machine identifier:** Label identifying the machine.
2. **Time:** Time and minutes in the selected format.
3. **Programme running:** Programme name, Programme number, Programme length.
4. **Programme progress indicator:** Status of programme progress, relation between total time and time remaining for programme.

5. **Programme number and length:** Position of the programme in the list of programmes (My Programmes), and the estimated length in minutes for the programme selected.
6. **Status (drawing):** Animated drawing showing the current cycle of the washing machine (filling, draining, washing, rinsing, spinning or untangling).

	Opening door.		Forward tilting.
	Heating		Backward tilting.
	Untangling.		Spinning.
	Cooling.		Finalising.
	Filling.		Washing.
	Stopping.		Programmed stop.
	Drying clothes.		Draining.

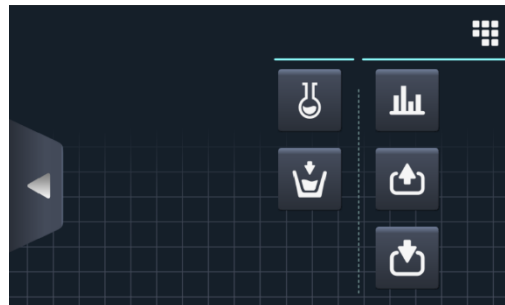
7. **Currently running cycle:** Identifier and name of currently running cycle.
8. **Next cycle:** Identifier, name and drawing of next cycle (if the current cycle is the last cycle, nothing is displayed).
9. **Advance cycle:** Button to go to next cycle (if the current cycle is the last cycle, nothing is displayed). As well as using the button, the cycle can be advanced by pressing directly on the information for the next cycle (just above the button).
10. **Pause:** Button to pause the current programme. If the programme is paused, the pause icon will change to the play icon. The programme can be restarted from where it was interrupted.
11. **Stop:** Button to stop and cancel the **programme**. A confirmation message will be requested.
12.  **Run menu:** Access to the current parameters.



-  **Inputs:** The status of each of the inputs is displayed. The inputs which are available in all the machines are always displayed. The inputs which are exclusive to a particular feature (for example, Self-service, Sanitary, Extra dispensers, Tanks (T1, T2, T3), Tilting...) will only be available if this feature is activated.

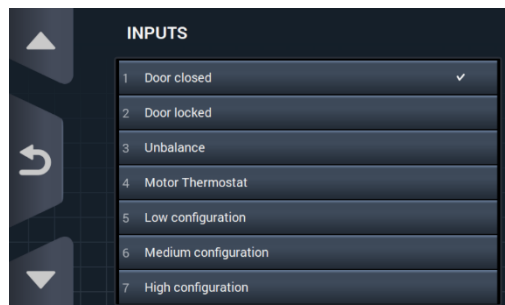

- 
Outputs: The status of each of the outputs is displayed. The outputs which are available in all the machines are always displayed. The outputs which are exclusive to a particular feature (for example, Self-service, Sanitary, Extra dispensers, Tanks (T1, T2, T3), Tilting...) will only be available if this feature is activated.

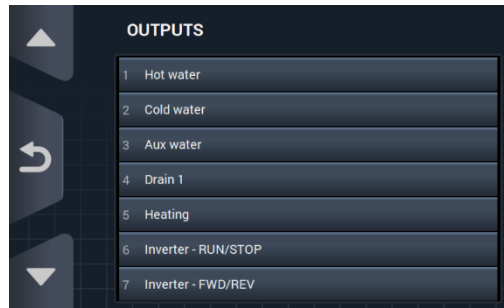

- 
Settings/values: Display of settings and true values for the current cycle (Temperature, Level, Time remaining). Press the buttons on the right column to edit the settings. The changes will only affect the current wash.

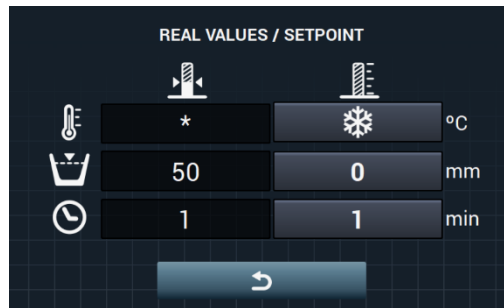

- 
Manual dosing: This section can be accessed, the state of each dispenser (ON /OFF) is displayed, and the required dose can be activated/deactivated. The available options will be based on the configuration of existing kits. On exiting the dosing window, all the dispensers are deactivated.



- 
Manual water inlet: This section can be accessed, the state of each water inlet (ON /OFF) is displayed, and the required inlet can be activated/deactivated. The water inlet that has been activated by the fill logarithm cannot be deactivated. On exiting the water inlet window, all the manually activated water inlets will be deactivated.

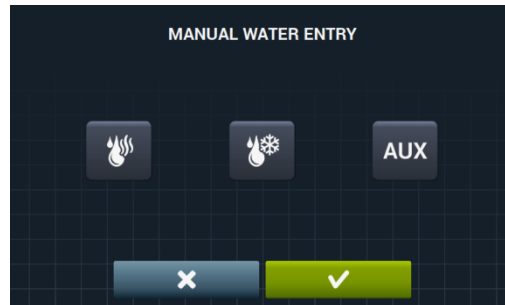

3 PROGRAMMES

There is a programme library consisting of all the programmes installed by default, together with the programmes created by the user.





Before explaining the programme management (see section 4.1), details are given of their parameters and of the standard programmes found in the library.

3.1 Cycle parameters

Each programme is made up of a series of cycles, consisting of a set of parameters which can be configured, depending on the cycle type in question.

3.1.1 Parameters for soak, prewash, wash or rinse cycles:



- Cycle name:** Name identifying the cycle. This is not the text displayed on the *Run screen*, but the text which identifies a created cycle.
- 
Time: Value, in minutes, of the cycle length. Range can be configured from 1 to 99.
- 
Temperature: Temperature, °C or °F, of current cycle. Range can be configured from 20°C (68°F) to 90°C (194°F).
- 
Level: Water level at which cycle should be run. Ranges which can be configured (see section 4.2). There are 5 types of level: Minimum (1), Low (2), Medium (3), High (4), Maximum (5). Please refer to table of levels by model (see section 4.4.). Range can be configured.
- 
Speed: Speed of current cycle. Ranges which can be configured (see section 4.2). There are 4 different speeds to select from: Minimum (1), Low (2), Normal (3), High (4).
- 
Wash rate: Sequence of movement that washing machine must follow (run time (seconds) / stop time (seconds)). Range can be configured from 1 to 99. The drum alternately turns to the left and to the right..

- 
Water inlet: This indicates the selection of the required water inlet.
 - Hot water: Load water from the hot water inlet (Yes/No).
 - Cold water: Load water from the cold water inlet (Yes/No).
 - Auxiliary: Load water from the auxiliary water inlet (Yes/No).
 - Water adjustment: Load water from one or other inlet depending on the temperature (Yes/No).
 - T1, T2, T3: Load water from any of the tanks if recovery KIT is fitted.

- 
Drainage: This displays whether the water should be drained at the end of the cycle, indicating which outlet should be used if the recovery kit is active.

- 
Cooling: Option that permits the temperature in a cycle to be lowered before drainage or going to the next cycle. Configurable parameter only if the cycle temperature is equal to or higher than 40°C (104°F). Range can be configured from 30°C (86°F) to cycle setting.
- In addition to selecting the cooling value, there is a button to enable or disable this option.

- 
Dispenser 1.8: Each dispenser can be activated independently, and the following parameters must be configured if it is activated:
 - Start: If dispenser X is active, indicate when this dispenser should start dosing.







- Safety level (ML): Start dosing when the safety level is reached.
 - Level (L): Start dosing when the defined level is reached.
 - Temperature (T): Start dosing when the defined temperature is reached.
- Time: Time, in seconds, of dispenser X. Range can be configured from 0 to 99.

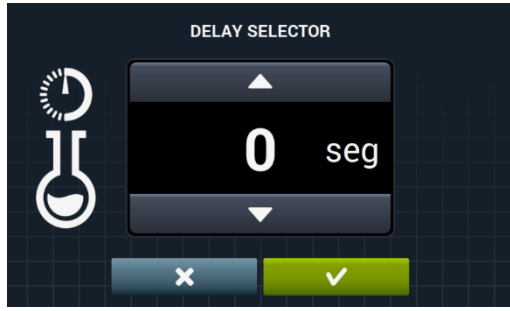







- Delay: Delay, in seconds, of dispenser X. From the moment the programme reaches the start point indicated, the dosing will be delayed for the time indicated. Range can be configured from 0 to (cycle time-dosing time).

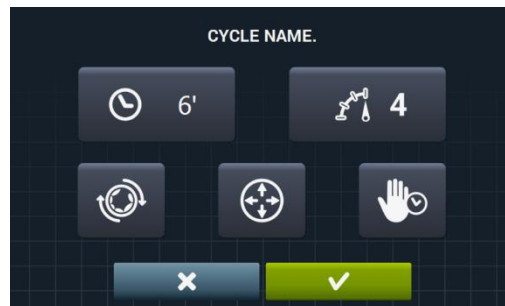

-  **Move while filling:** Rotate drum while machine is filling (Yes/No).
-  **Movement while draining:** Rotate drum while machine is draining (Yes/No).
-  **Thermal stop:** Indicate the moment from which the time stipulated for the cycle is counted (Yes/No).
-  **Pause programme:** This allows you to pause the programme before the cycle in question starts running. The pause will be indicated on the screen and an acoustic signal is emitted (Yes/No).
- If this parameter is active, before starting the cycle, the machine will go to pause status, and the message "Pause programmed" is displayed on the screen. To continue running the programme, press the PLAY button.

3.1.2 Parameters for spin cycles:











-  **6'** **Time:** Value, in minutes, of the spin length. Range can be configured from 1 to 99.
-  **4** **Speed:** Spin speed. There are 4 different speeds to select from: Minimum (1), Normal (2), Medium (3), Maximum (4). The Medium (3) and Maximum (4) values are only available in high- and medium-speed machines respectively. Range can be configured.
-  **Untangling:** Untangle at the end of the spin cycle (Yes/No).
-  **Optimum distribution:** If this option is active, the machine does not drain in the previous cycle.
-  **Pause programme:** This allows you to pause the programme before the cycle in question starts running. The pause will be indicated on the screen and an acoustic signal is emitted. (Yes/No).

3.2 Cycle library













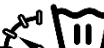

These are the cycles found by default in the cycle library. These cycles can be used to form new programmes.

- Soak cycles
 - **F1:** Soak
- Prewash cycles
 - **F2:** Normal Prewash Cold
 - **F3:** Normal Prewash 40°C (104°F)
 - **F4:** Delicate Prewash Cold
 - **F5:** Delicate Prewash 40°C (104°F)
 - **F6:** Very Delicate Prewash Cold
 - **F7:** Very Delicate Prewash 40°C (104°F)
 - **F8:** Wet Prewash
- Wash cycles
 - **F9:** Normal Wash Cold
 - **F10:** Normal Wash 60°C (140°F)
 - **F11:** Normal Wash 90°C (194°F)
 - **F12:** Delicate Wash Cold
 - **F13:** Delicate Wash 40°C (104°F)
 - **F14:** Very Delicate Wash Cold
 - **F15:** Very Delicate Wash 40°C (104°F)
 - **F16:** Wet Wash Cold
 - **F17:** Wet Wash 40°C (104°F)
- Rinse cycles
 - **F18:** Normal Rinse
 - **F19:** Normal Final Rinse
 - **F20:** Delicate Rinse
 - **F21:** Delicate Final Rinse
 - **F22:** Very Delicate Rinse
 - **F23:** Very Delicate Final Rinse
 - **F24:** Wet Rinse
 - **F25:** Wet Final Rinse
- Spin cycles
 - **F26:** Short Spin
 - **F27:** Long Spin









































Cycle symbols:

	Soak cycles	
	Prewash cycles	 : Prewash cold,  40: Pre-wash 40 °C (104°F)
	Wash cycles	...
	Rinse cycles	 : Rinse,  : Final rinse with softener
	Spin cycles	

Symbols and values of the parameters:

	Time	Value in minutes
	Temperature	Value in °C (°F)
	Level	1:Minimum, 2:Low, 3: Medium, 4:High, 5:Maximum
	Wash speed	1:Minimum, 2:Low, 3:Normal, 4:High
	Spin speed	2:Normal, 3:Rapid, 4:Maximum
	Water inlet	0:Cold, 1:Cold/Hot according to adjustment
	Wash rate	Run time (seconds) Stop time (seconds)
	Move while filling	✓ : Yes
	Thermal stop	✓ : Yes
	Movement in drainage	✓ : Yes
	Drainage	✓ : Yes
	Cooling	✓ : Yes
	Optimum distribution	✓ : Yes
	Stop programme	✓ : Yes
	Untangling	✓ : Yes
D	Dispenser	Input through which dose enters (D1:Dispenser 1, ...) with the START/TIME/DELAY programmed at ML/0/30

Tables of cycles with their parameters:

	F1		F2		F3		F4		F5		F6		F7		F8
			 	 40	 	 40	 	 40	 						
	3		5	5	6	6	6	6	6	6	6	6	6	5	
	3			40		40		40		40		40			
	3		1	1	3	3	3	3	3	3	3	3	3	3	
	0		3	3	2	2	2	2	2	2	2	2	2	1	
	15;05		0	1	0	1	0	1	0	1	0	1	0	0	
	✓		15;05	15;05	10;08	08;06	5;15	5;15	02;02						
	✓		✓	✓										✓	
	✓			✓		✓						✓			
	✓		✓	✓										✓	
	✓		✓	✓	✓	✓	✓	✓	✓	✓	✓	✓	✓	✓	✓
D	D1	D	D1	D1	D1	D1	D1	D1	D1	D1	D1	D1	D1	D1	D1

	F9	F10	F11	F12	F13	F14	F15	F16	F17
	10	10	10	12	12	12	12	10	10
		60	90		40		40		40
	1	1	1	1	1	1	1	2	2
	3	3	3	2	2	2	2	1	1
	0	1	1	0	1	0	1	0	1
	15;05	15;05	15;05	10;08	10;08	05;15	05;15	02;02	02;02
	✓	✓	✓					✓	✓
		✓	✓		✓		✓		✓
	✓	✓	✓					✓	✓
	✓	✓	✓	✓	✓	✓	✓	✓	✓
D	D2, D3	D2, D3	D2, D3	D2	D2	D2	D2	D2	D2

	F18	F19	F20	F21	F22	F23	F24	F25
	2	2	3	3	3	3	2	2
	4	4	4	4	4	4	4	4
	3	3	2	2	2	2	1	1
	15;05	15;05	10;08	10;08	05;15	05;15	02;02	02;02
	✓	✓					✓	✓
	✓	✓					✓	✓
	✓	✓	✓	✓	✓	✓	✓	✓
D		D4		D4		D4		D4

	F26	F27
	2	6
	2	4
	✓	✓
	✓	✓

3.3 Programme library

These are the programmes that are found by default in the programme library:

P1: Energetic 90°C (194°F)	P10: Extra delicates Cold
P2: Energetic 60°C (140°F)	P11: Economy 90°C (194°F)
P3: Energetic 30°C (86°F)	P12: Economy 60°C (140°F)
P4: Energetic cold	P13: Economy 30°C (86°F)
P5: Normal 60°C (140°F)	P14: Economy cold
P6: Normal 30°C (86°F)	P15: Sluice
P7: Normal cold	P16: Long spin
P8: Delicates 40°C (104°F)	P17: Short spin
P9: Delicates cold	



The table of all the programmes with their parameters can be found at the end of the manual.

4 CONFIGURATION

The main configuration menu of the washing machine is shown below. Here, it is possible to configure different washing machine parameters, and display or download stored data.

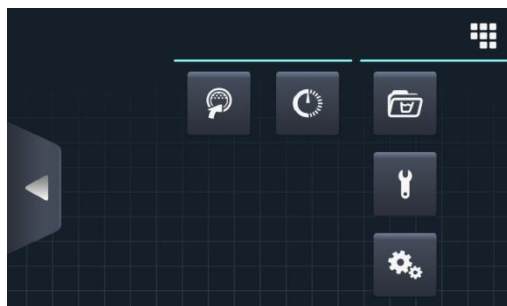
This menu is entered from the icon  in the **Main screen** (see section 2.2)





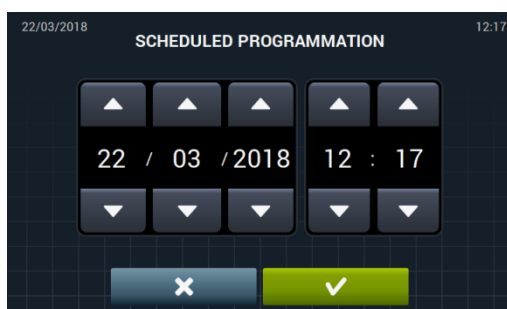

-  **Easy load:** Option which helps load the laundry.
-  **Delayed programming:** This allows a wash to be delayed so that it runs on the date/at the time required. After pressing the “delayed programming” button, you are asked to enter the required date/time.

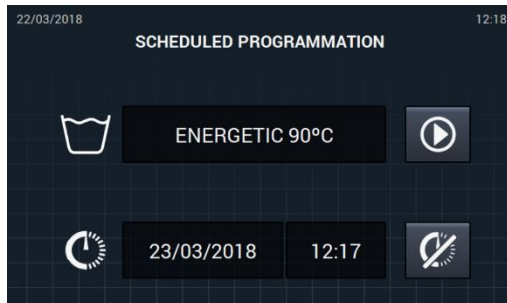

A screen is displayed which indicates the date/time of the programme, together with the programme name and number.





-  Run the programme before the scheduled time.
-  Cancel the programming.
-  **Programme management:** Management of all the stored programmes, and all the currently active programmes. (See section 4.1)
-  **Configure system:** Configuration of different sections of the washing machine. (See section 4.2)
-  **Maintenance:** Various password-protected options for the technician.

4.1 Programme management

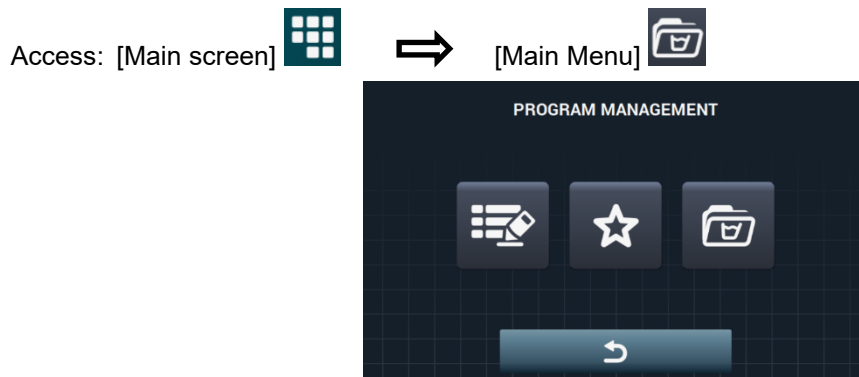
From this submenu it is possible to manage all the programmes, both those selected by the user and those that are in the library. To do so, select between “Cycle library”, “My programmes”, and “Programme library”.





There is a library in which all the programmes and cycles are stored, including programmes stored by default and programmes created/imported by the user.

-  **My programmes:** Available in the OPL main screen. (See section 4.1.1)
-  **Programme library:** (See section 4.1.2)
-  **Cycle library:** (See section 4.1.3)

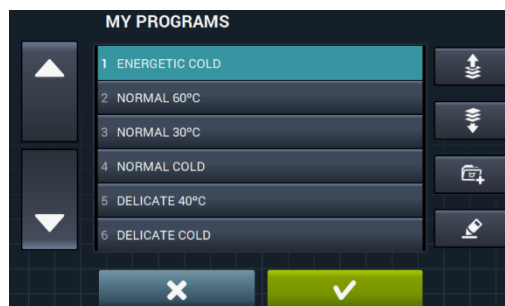

4.1.1 My programmes (favourites).

The programmes in the folder “My programmes” are those which are available on the OPL Main Screen.

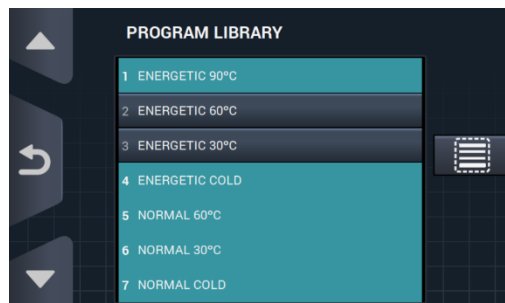

-  **Add/remove programmes:** Press this to go to the programme library. Here, the programmes which are currently included in “My programmes” are highlighted, and it is possible to select/deselect each of the programmes to be added to/removed from the list of favourites.
 -  **Select/deselect all:** Select or deselect all the programmes in the programme library.



-  **“up arrow”** and  **“down arrow”:** Use these buttons to change the position of any programme in the list of favourites, which can be placed in any order as required.

- 
Edit button: Press this to modify the selected programme as if editing it from the programme library.



Press OK or Cancel to return to My Programmes.

4.1.2 Programme library

Programmes can be added, copied, modified or deleted, new programmes can be imported or programmes can be exported to a USB flash drive.



- 
Create programme: Creation of new wash programmes using cycles existing in the library. When this button is pressed, the user is asked to enter the name of the new programme.

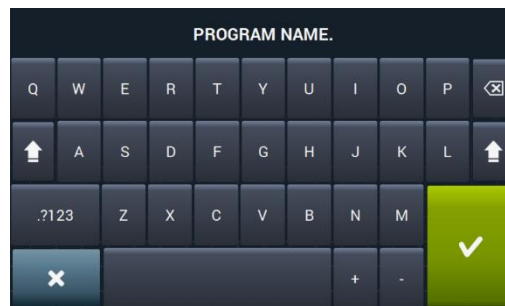

Next the following screen is displayed (without any cycles) in order to include cycles from the cycle library.

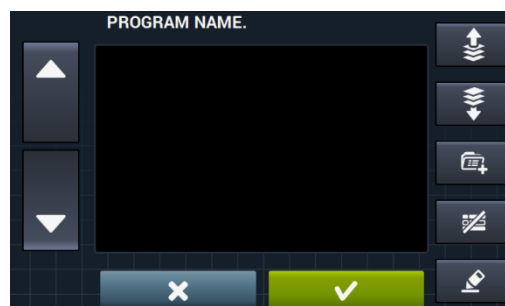



- 
 Cycles can be added from the cycle library. The cycles you wish to view can be filtered by cycle type.





After selecting the cycle, the library cycle parameters can be consulted before including them in the programme you are creating.



Each programme is a set of parameters grouped by cycles that are not linked to any of the cycles found in the library.



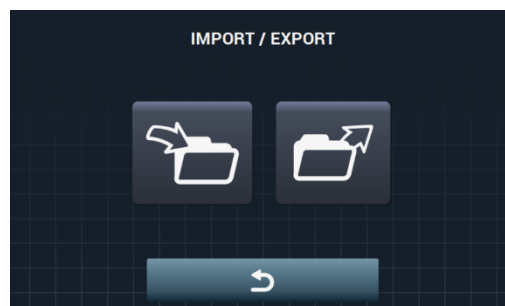

- 
Copy programme: Copy of a programme found in the library, giving it a new name.
- 
Modify programme: Modification of the name of the programme and the cycles in the programme. It is possible to add, modify, delete or change the order of existing cycles. Just as when a new programme is created, when it is modified it is possible to add/delete cycles from the cycle library.

When creating programmes, the cycle parameters can only be consulted. The cycles already in the programme can only be modified when modifying the programmes.
- 
Delete programme: Delete programmes stored in the library.
- 
Import/export programme: This permits programmes to be imported/exported from an external USB flash drive.



- 
Import programme: Permits new programmes to be imported from a USB flash drive. On opening the USB folder, only the files with “. prg” extension and the folders are displayed.



-  **Marker:** Indicates the number of programmes selected.
-  **Select/deselect all:** Select or deselect all the programmes in the current folder.
-  **Return:** This allows you to exit the current folder.
- If a programme is imported with the same name as an existing programme, you will be asked whether you wish to replace the programme in question or cancel the operation. As there may be many programmes in this situation, there is a box to select “do the same in all cases”.
-  **Export programme:** Export programmes existing in the library to a USB flash drive.



It is possible to select the programmes you wish to export.

-  **Select/deselect favourites:** This allows you to select all the programmes or the programmes which are saved in favourites, indicating the number of programmes selected at all times.

The set of programmes selected will be saved in a folder “PROGRAMMES” in the USB root directory and each programme will be a file.

4.1.3 Cycle library

The name of each cycle can be modified from the cycle library. Once included in a programme, when displaying the cycle information, the name displayed for the cycle will be different. It will be a dynamic name consisting of the phase type and a parameter (T°, rpm)

The cycle library will be editable, and the existing cycles can be created, modified, copied or deleted (See section 3.1).

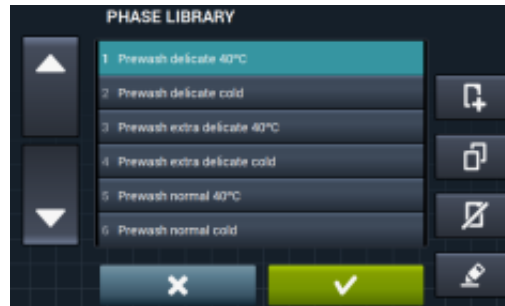

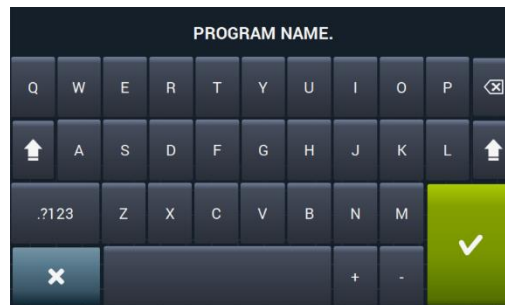

- 
Create cycle: Creation of new wash cycles. When this button is pressed, the user is asked to enter the name of the new programme.

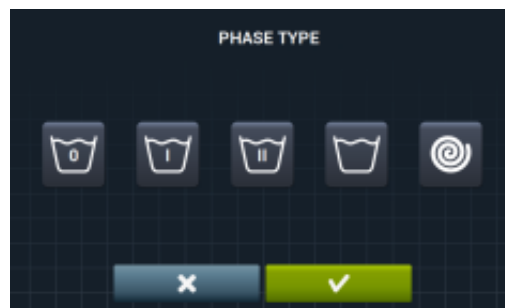

Next, the following screen is displayed to select the cycle type to be created: soak, prewash, wash, rinse or spin.







- 
Copy cycle: Copy an existing cycle from the library, giving it a new name.
- 
Delete cycle: Delete cycles stored in the library.
- 
Change cycle: Modification of the selected cycle parameters.

4.2 Configure System

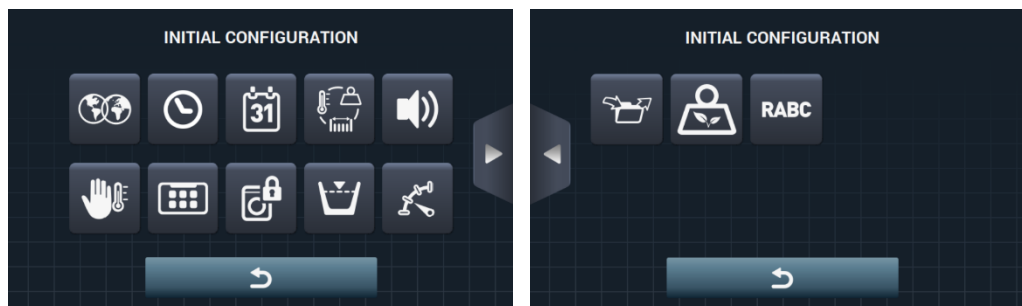
Access: [Main screen]  \Rightarrow [Main Menu] 

The following sections can be modified in the system configuration:



-  **Next screen.**
-  **Previous screen.**
-  **Language:** The washing machine texts can be displayed in 34 different languages, although the texts can only be edited using Western character sets.

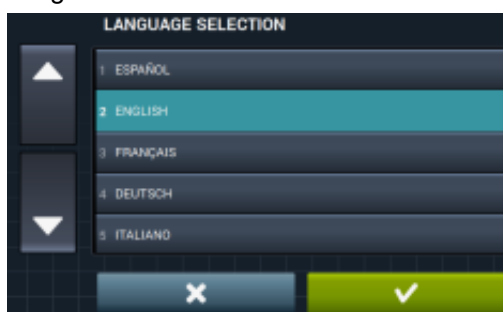

-  **Time:** Configuration of the current time. The display format (12 hour / 24 hour (default setting)) can be selected.

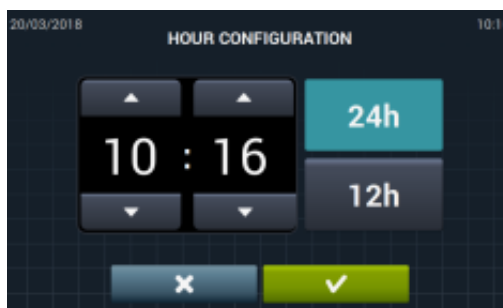

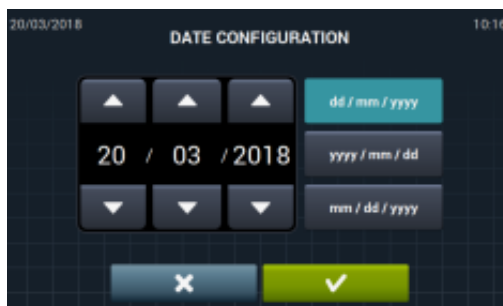

-  **Date:** Configuration of the current date. The display format (dd/mm/yyyy (default setting) / yyyy/mm/dd / mm/dd/yyyy) can be selected.







- 
Units of measurement: The unit of measurement in which the temperature (°C (default setting) or °F), the weight (Kg (default setting) or lb) and the size (mm (default setting) or in) can be selected.







- 
Thermal stop: General configuration of the thermal stop. If this is disabled, the thermal stop does not take place even if this parameter is active in the currently running cycle. If, however, it is enabled, the configuration of each cycle is respected and the consequent action is taken. By default it is active. In machines without heating, (HW) is always deactivated.
- 
Water saving by weight: The required water saving for the weight can be configured. Three different weight options and three levels of saving can be selected. Depending on the load, there will be a reduction in the water level and detergent dose.

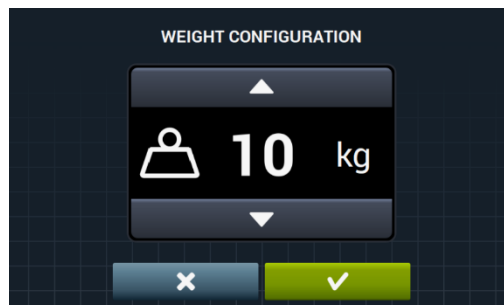

- 
 Weight option off.
- 
 Automatic weight option. This is available depending on the configuration of existing kits.
- 
 Manual weight option. Enter the weight of the clothing manually by pressing the weight icon on the main screen. (See section 2.2, point 3).
- 
 Smart weight option. This option estimates the load weight at the start of each programme. The message "LOAD DETECTION" is displayed while it is running. This option may last several minutes. The time required for this is not included in the programme duration.





- 
 Savings option off.
- 
 Low savings option.
- 
 Medium savings option.
- 
 High savings option.

- 
Levels: This enables the configuration in mm of the 5 configurable levels. Each level type will have a default value and configuration range. These values will depend on the model selected. (See table of levels by model).

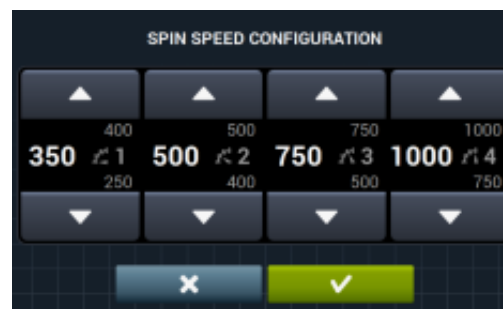
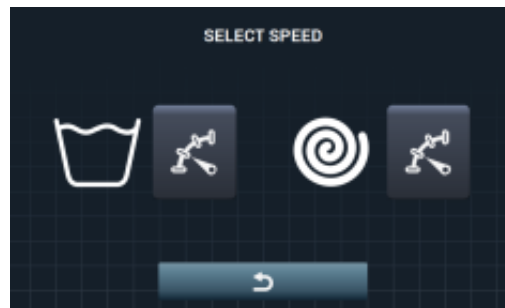

- 
Speed: This enables the configuration in RPM of the different types of speed existing, in both the wash and spin cycles. Each speed type has a minimum and maximum configuration value. (See table of RPM/V equivalences by model).



- 
Import/Export Configuration: It is possible to import a machine configuration from a USB memory stick or to export the current machine configuration to a memory stick. When this button is pressed, an intermediate window is displayed where we select whether to import or export.

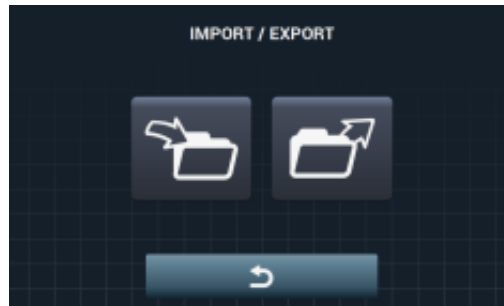

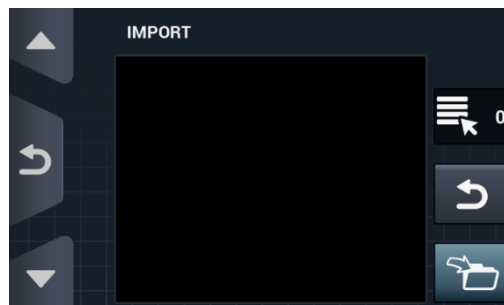

If IMPORT is selected, a screen is displayed to permit browsing through the USB. But only configuration files (with extension .cfg) can be selected.



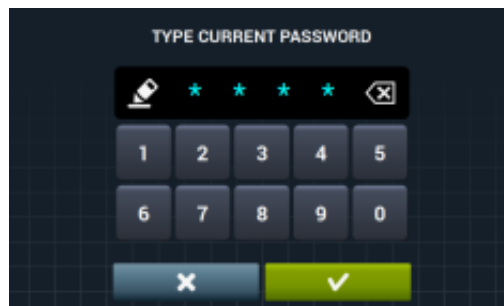

If EXPORT is selected, the current machine configuration is saved to the USB root directory in the folder "CONFIGS". Each configuration file name will take the following format: CONFIG_Model_Date_time.cfg.

- 
Restricted access: This allows the washing machine configuration to be restricted, by establishing a password to enter the main menu. The default setting is deactivated. The required password (1234 by default) for entering the main menu can be configured.



- 
HUD: The HUD configuration activates/deactivates the display of the parameters on the different screens (See section 4.2.1).





-  **Beep:** Option permitting the buzzer to be disabled. By default it is enabled.
-  **RABC/Traceability:** The information for each wash is registered, and the following information saved:
At the start of each cycle: Programme, start time, weight (where applicable). During the programme, every 15 seconds: Level, temperature and error (where applicable). When downloading the data, the required period must be selected (by default, start date and end date, today's date).
The data will be saved for a minimum of 15 days.
Each time there is a download, an "RABC" will be created in the USB root directory. Each RABC file name will take the following format: RABC_Model_Date_time.rabc..



4.2.1 HUD configuration

Configuration of the parameters to be displayed on the OFF screen, main screen and run screen, in addition to configuration of the automatic shutdown and energy saving.

Access: [Main screen]  ⇒ [Main Menu]  ⇒ [Configure system] 

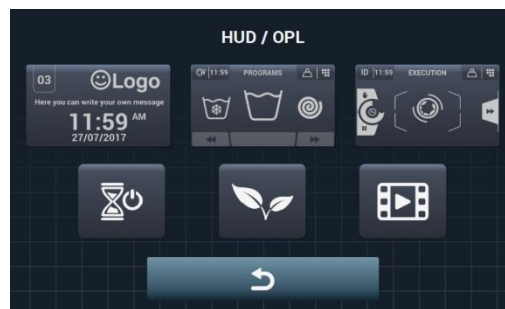

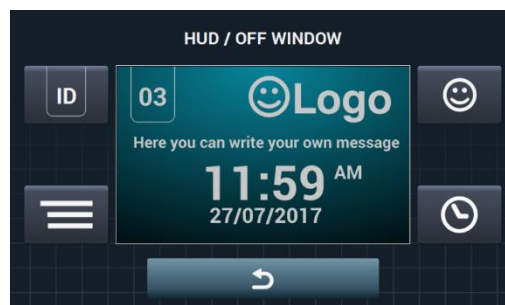

-  **OFF screen:** These are the parameters that can be configured:



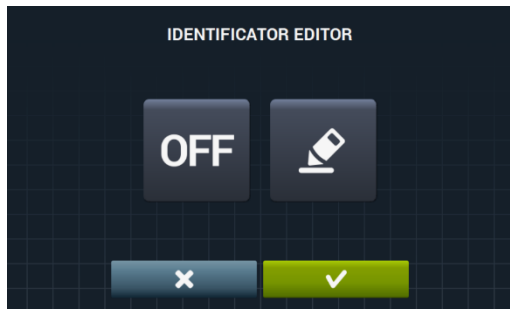

-  **Machine identifier:** The machine identifier can be enabled/disabled, and the number to be allocated to the identifier can be edited (between 1 and 99). By default it is disabled. This identifier is obligatory if remote communication is used.



The machine identifier is enabled by pressing "OFF"  followed by the edit button .



-  **Date:** Option that can be enabled/disabled. By default it is enabled.
-  **Logo:** This allows the user to select whether or not to display the logo. By default it is enabled.

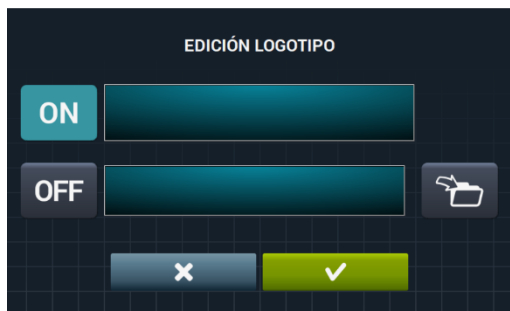

Press import  to import a logotype to the machine from an external USB flash drive. The logotype file must be a .png type with a resolution of 290 x 80 pixels.

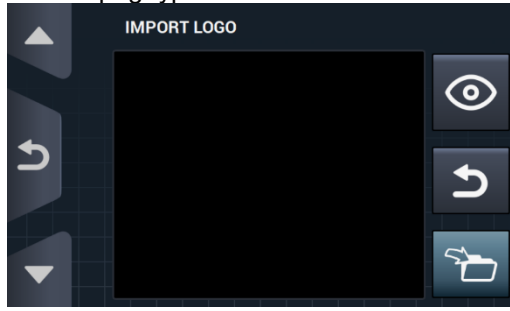





The preview button , allows you to confirm that the logotype is correctly displayed.

-  **Laundrette message:** Start message that can be edited by the user (max. 40 characters). By default it is disabled.

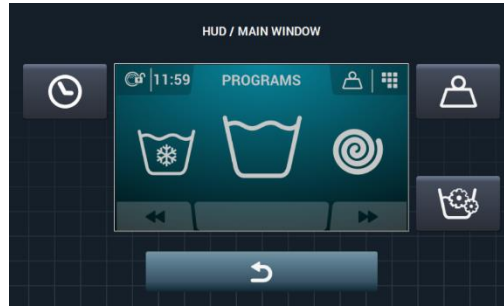

- **Main screen:** The configurable parameters are listed below:





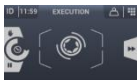



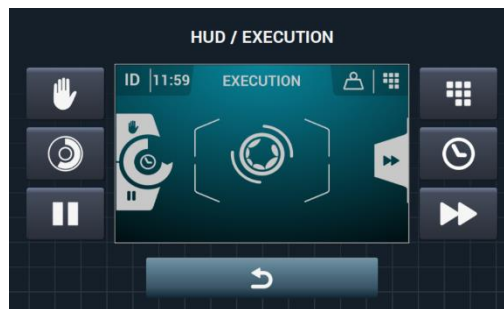

-  **Time:** Option permitting time to be displayed/hidden. By default it is enabled.
-  **Weight of clothes:** If this option is disabled, the weight icon is not displayed. By default it is disabled.
-  **Instant programming:** If instant programming is disabled, the parameters for each cycle can be viewed but cannot be edited. By default it is enabled.



- **Run screen:** These are the options permitted on the run screen:



-  **Time:** Option permitting time to be displayed/hidden. By default it is enabled.
-  **Remaining time:** Option to display/hide the total time remaining and the programme progress indicator on the run screen. By default it is enabled.
-  **Stop button, STOP:** This allows the stop button to be hidden. By default it is enabled.
-  **PAUSE button:** This allows the pause button to be hidden. By default it is enabled.
-  **Menu button:** Option that permits the run menu icon to be displayed/hidden, by default it is enabled.
-  **Advance button:** This permits the advance button and the information referring to the next cycle to be hidden. By default it is enabled.
-  **Automatic shutdown:** If this option is activated and the main screen is open, the machine will switch to *Screen Off* after 30 minutes of inactivity. By default it is enabled.
-  **Energy savings:** Option that enables energy savings by switching off the screen backlight 10 minutes after switching off the washing machine. If any part of the screen is touched, the backlight will light up again, and the main Screen is opened. By default it is enabled.
-  **Import video:** This permits a video to be played on the machine screen after 10 minutes of inactivity. If "Energy saving" is activated, the video is automatically stopped.

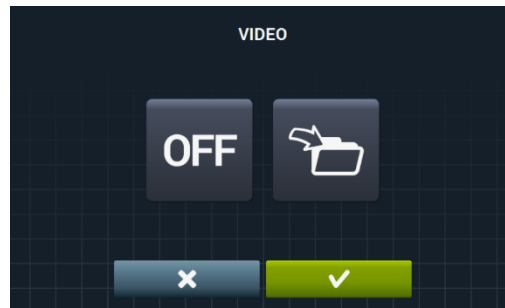

Press import  to import a video to the machine from an external USB flash drive. Only video files (avi, mov...) can be imported, and only one video file can be installed on the machine. The recommended resolution of the videos is 480x272 pixels for machines with a 4.3" screen, and 800x480 pixels for 7" screens. The 16 Fps should not be exceeded. The maximum file size must not be more than 25 Mb.

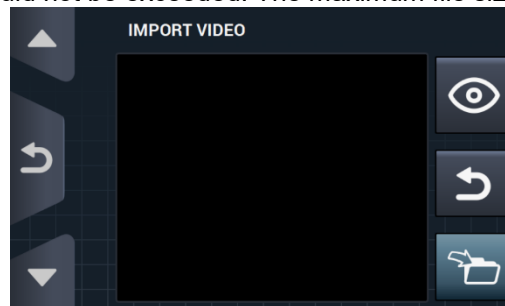

The preview button , allows you to check the video file plays correctly.

5 MAINTENANCE

5.1 Electrical and mechanical irregularities

Before calling the Technical Service Centre, check the following:

- That power is supplied to the machine.
- The condition of the fuses.
- That the voltage is correct for the machine.

If the washing machine fails to get the required level of water, check:

- The water mains tap is open.
- The water inlet filter is not blocked.
- That the water pressure is between 2 and 4 kg/cm 28 (28 and 56 psi).

If the washing machine vibrates excessively, check that none of the panel screws is loose.

If a power cut occurs, check that the tub is drained and the door is blocked. If you want to take the clothes out of the washing machine, unlock the door by pulling down the belt located behind the front panel.

5.2 Warnings

All warnings and errors are reported on screen together with an acoustic alarm. In the event of an error, the cycle and status information is maintained in order to determine exactly where the error has occurred.

The following warnings may be found in a washing machine:

DESCRIPTION	CAUSE AND ACTION
OPEN DOOR	If the door is open at the start of a programme, the message "DOOR OPEN" is displayed on screen and the buzzer will buzz for 30 seconds and no more. Only the option "OK" is given. The programme will not start and the user can try again.
WATER IN TUB	At the end of a programme, if the water level is not 0 mm, the message "WATER IN TUB" is displayed on screen. The 2 options "continue" or "end" are displayed. If we press "continue" the machine checks again for a level of 0 mm. If this is the case, the door is unlocked, if not the error is reported again. If we press "end", the programme will end and the door unlocks.
NO COMMUNICATION BETWEEN CARDS	In the SAT menu, in the Extra Kit section, on activating a kit, if no communication is detected between the principal control card and the auxiliary card, this warning is displayed. Active kits without communication between cards can be deactivated, but they cannot be activated.
FULL TANKS (T1/T2/T3)	This warning is displayed when Tank Tx is active in a drainage cycle and the input "Max level Tank x" is found to be activated. The machine stops draining to Tx and switches to normal drainage D1. Buzzer is activated for 10 seconds. The warning disappears on pressing OK or after a certain time interval.
EMPTY TANKS (T1/T2/T3)	This warning is displayed when Tank Tx is active in a fill cycle and the input "Min level Tank x" has been activated. The machine stops filling from Tx and switches to filling normally with cold water. Buzzer is activated for 10 seconds. The warning disappears on pressing OK or after a certain time interval.
NO COMMUNICATION WITH WEIGHING KIT	This warning is displayed if, on activating the weighing kit or making a calibration, the auxiliary card is connected and operating correctly, but it is not possible to communicate with the weighing appliance. It is not possible to activate the kit or make the calibration.

<p>CALIBRATION OF WEIGHING KIT – ENSURE MACHINE IS EMPTY</p>	<p>This warning is displayed on launching a calibration of the weighing kit, in order to inform the user that the machine must be empty, with no additional weights on top, etc., before launching a calibration. None. Warning is for information only. "OK" button to hide warning and launch calibration.</p>
<p>CALIBRATION OF WEIGHING KIT – PROCESS UNDER WAY</p>	<p>This warning is displayed while the weighing kit calibration is in process. None. Warning is for information only. There is no button and the text is displayed for 5 seconds while the calibration is in process.</p>
<p>CALIBRATION OF WEIGHING KIT – CALIBRATION ERROR</p>	<p>This warning is displayed when, on completion of the calibration process, it has not been possible to set the weighing system to zero correctly. None. Warning is for information only. "OK" button to hide warning.</p>
<p>CALIBRATION OF WEIGHING KIT – CALIBRATION REQUIRED</p>	<p>This warning is displayed when, on pressing "Start" to run a wash programme, a weight 3 Kg less or 10 Kg more than the nominal weight is measured. The 2 options "Cancel" or "OK" are displayed. Press "OK" to continue with the programme with the nominal weight. Press "Cancel" to abort the programme.</p>
<p>EASY LOAD – LAUNCH PROCESS</p>	<p>This warning is displayed on pressing the Easy Load button on the main screen. The user will be told to insert the laundry and close the door and then asked if they wish to launch the Easy Load cycle. The 2 options "Cancel" or "OK" are displayed. Press "Cancel" to abort the Easy Load cycle and return to the selection screen. Press "OK" to launch the Easy Load cycle.</p>
<p>EASY LOAD – CYCLE RUNNING</p>	<p>This warning is displayed while the Easy Load cycle is running, advising the user that it is in process. No buttons are available. Message is solely for information; the user can do nothing except wait for the cycle to end.</p>
<p>LOAD DETECTION</p>	<p>This message is displayed at the start of the wash programme when the "smart weight" option is on. No buttons are available. Message is for information only. This operation may last several minutes.</p>

The following errors may be found in a washing machine:

ERROR	DESCRIPTION	CAUSE AND ACTION
E1	POWER CUT DETECTED	This error is displayed when the power is restored after a power cut has been registered while a programme is running. The machine automatically returns to the point in the programme where it left it, displaying a warning message for 30 seconds. The options "continue" or "end" are displayed. If continue is pressed, the cycle that was running when the power cut occurred will continue, starting from the beginning of the cycle again. If "end" is pressed, the programme will end, and the door is unlocked.
E2	FAULT IN LOCKING	This error is displayed at the start of a programme and it is not possible to lock or unlock the door while the programme is running. The programme will end and you can try again, ensuring that the door is correctly closed. If the problem persists, call the technical service.
E3	DRAINAGE FAILURE / WATER IN TUB	This error is displayed when the washing machine is not able to drain the water from the drum. Two options are displayed: "continue" or "end". Check that the drainage is not blocked. If the machine is fitted with a drainage pump, clean the filter.
E4	MAXIMUM WATER LEVEL REACHED	This error is displayed when the washing machine detects a water level which is too high. Check that no water enters while the washing machine is at rest. If this is the case, call the technical service.
E5	WATER INLET FAULT	This error is displayed when the washing machine detects that no water is entering the machine. Before calling the technical service: Check that the shut-off valve is open. Check that the drainage configuration is correct (valve / pump).
E6	HEATING FAULT	This error is displayed when the washing machine is not able to heat the water correctly. Before calling the technical service, check that the heating configuration is correct.
E7	"MAXIMUM TEMPERATURE REACHED"	This error is displayed when the temperature detected is too high. Only the option "end" is given. When it is pressed the programme will end, if the temperature is less than 50°. If this is not the case, the E11 error is triggered: CLOTHES HOT
E8	MOVEMENT ERROR	This error is displayed when the washing machine does not detect any movement. The warning "The programme will end" is displayed and after 2 minutes, the OK button is shown. Press this to end the programme.

E9	UNBALANCED LOAD	This error is displayed when the washing machine is not able to balance the clothes. Try to load the clothes more evenly.
E10	MAX UNBALANCED LOAD	This error is displayed when the washing machine detects too much movement during the spin cycle. If this error appears repeatedly, call the technical service. There may be a problem with the installation and/or shock absorber system.
E11	CLOTHES HOT	This error is displayed when the temperature within the tub is higher than 50 °C (122 °F) at the end of the programme. Wait until the temperature falls below 50 °C (122 °F), and the programme will end automatically.
E12	UNLOCK ERROR	This error is displayed when the washing machine is not able to unlock the door at the end of a programme. This error occurs after 3 attempts to unlock the door every 20 seconds. Only the option "end" is given. When this is pressed, the machine will try again and if it is unable to unlock the door, the error will continue to be displayed. Do not force the door. Call the technical service and they will advise you on how to open the door safely.
E23	WEIGHING ERROR	This error is displayed when the washing machine detects an error in the communication with the weighing device. Call the technical service. The two options "OK" or "Cancel" are displayed. Press "Cancel" to abort the programme and return to the selection menu. Press "OK" to continue running the programme with the nominal weight value of the machine.
E25	CONTROL-CONTROL AUX COMMUNICATION ERROR	This error is displayed when the washing machine detects an error in the communication with the auxiliary card used in different accessories. Call the technical service. The two options "OK" or "Cancel" are displayed. Press "Cancel" to abort the programme and return to the selection menu. Press "OK" to continue running the programme, ignoring the corresponding accessory function.
E26	MOTOR HOT WIRE ERROR	This error is displayed when the temperature detected in the motor is too high. Call the technical service.
E27	NTC OUT OF RANGE ERROR	This error is displayed when the temperature detected is out of range. The temperature sensor is disconnected or damaged. Call the technical service. Two options "OK" or "Cancel" are displayed. Press "OK" to continue with the programme, ignoring the heating and press "Cancel" to end the programme.
E28	ERROR PRESSURE SENSOR OUT OF RANGE	This error is displayed when the washing machine detects a water level which is out of range. The pressure sensor is disconnected or damaged. Call the technical service. This error will not display any buttons and it is only possible to abort by switching off the machine.

SELF SERVICE V2.0

6	INTRODUCTION.....	35
7	INTERFACE.....	35
7.1	Selection Screen 1 - Buttons	35
7.2	Selection Screen 2 - Payment	36
7.3	Coin pulses and “Credit mode”	36
7.4	Run Screen	37
8	PROGRAMMES.....	38
8.1	Programme library	38
9	CONFIGURATION.....	39
9.1	Programme management	39
9.2	Configure System	39
9.2.1	Advanced configuration	39
9.2.2	HUD programming	45
9.2.3	Table of currencies	47
10	MAINTENANCE.....	49
10.1	Errors	49

6 INTRODUCTION

This section lists the characteristics which are exclusive to self-service washing machines. The safety warnings must be read and it is advisable to read the rest of the manual in order to fully understand how the machine operates.

7 INTERFACE

7.1 Selection Screen 1 - Buttons

When the machine is switched on, *Selection Screen 1* is displayed. There are 4 large fixed buttons on this screen for selecting wash programmes.

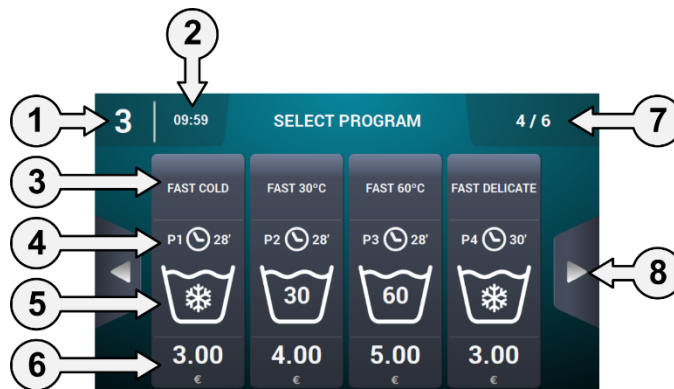

1. **Machine identifier:** The label identifying the appliance based on the existing configuration is displayed (if enabled).
2. **Time:** The current time is displayed in the format selected by the user.
3. **Programme name:** Name configured for the selected programme.
4. **Programme length:** Estimated length, in minutes, for the selected programme.
5. **Programme temperature:** Maximum temperature of the different cycles of the programme.
6. **Price:** Only in Coin mode, in CP and CR mode the price is not displayed and an LED is shown in its place.
7. **Number of programmes:** The number of programmes displayed and the number of available programmes are given. A maximum of 4 programmes are shown on screen, and the maximum number of programmes to be shown is 16 (4 screens with 4 buttons).
8. **Side browser arrows:** If there are more than 4 programmes in favourites, the side browser arrows are displayed. These allow you to move to the next selection screen.

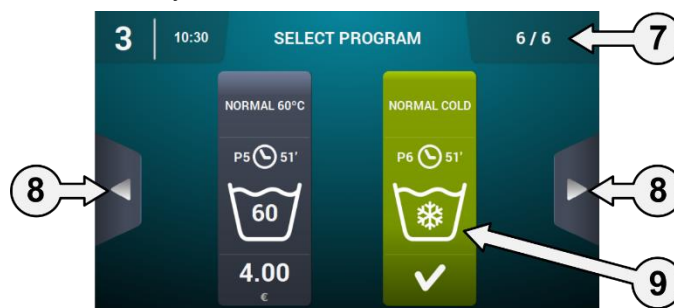

9. **Active button:** Payment may be made in this first screen. When the cost of the programme has been reached, the price disappears and the colour of the button changes, indicating that the programme is ready to be run.

Press a programme button to go to "Selection Screen 2 – Payment".

On completion of a programme, the machine returns directly to this screen.

In addition, even if the screen has been touched, or money has been inserted, if there is no activity within 15 minutes, the machine returns to this screen, resetting the amount which might have been inserted.

7.2 Selection Screen 2 - Payment

This screen offers the same information as in the previous screen, but only for the selected programme, accompanied by pictures and text to help. There are also two browser buttons for changing the programme.

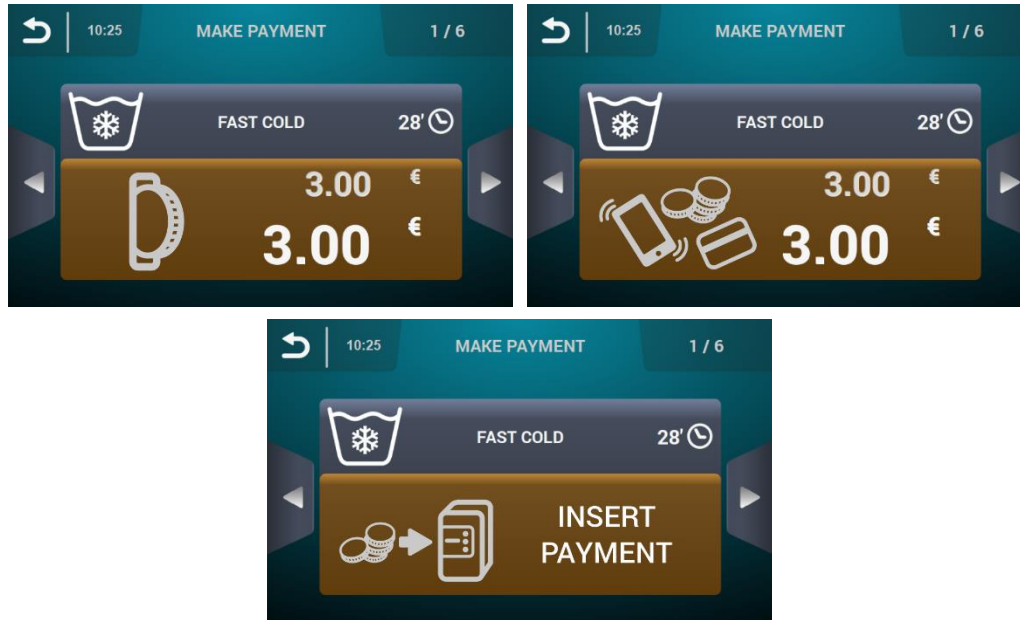

The button is displayed in brown until the amount indicated in the programme has been inserted in the machine.

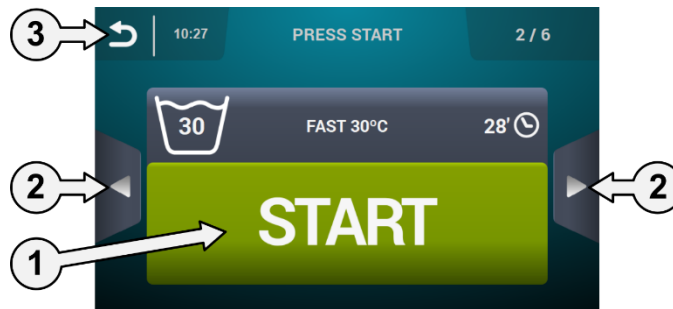

1. **Start Button:** When the programme amount has been inserted, a large "Start" button is displayed in green.
2. **Browser buttons:** This allows you to change programme.
3. **Return button:** Press this button to return to the main screen "Selection 1 – Buttons".

If there is no activity for 15 minutes, the amount inserted is reset, the money is lost and the machine returns to the screen "Selection 1 – Buttons".

On pressing the "Start" button, the selected programme starts to run.

7.3 Coin pulses and "Credit mode"

To run any programme, the corresponding payment must first be made. Depending on the existing self-service configuration, the machine controls the insertion of coins (COIN mode) or receives the corresponding signal in CP or Multipayment mode via the "coin slot micro" input to allow the selected programme to run.

While in self-service mode (both on selection screen 1, and screen 2, shown as running a self-service programme), it is possible to enter "Credit mode". If the "top open" input is activated in the industrial models, or the coin slot key or CP of the professional models is activated, a password is requested to enter in "Credit mode".

When the machine enters "Credit mode", it automatically exits self-service mode and behaves as if it were in normal mode, displaying the information defined on the *OPL Main Screen* and offering the option to perform all the actions defined on this screen. The programmes selected for self-service and the programmes defined for Credit Mode are displayed.

On going to the main menu, all the available options for self-service washing machines are displayed.

If the “top open” input is deactivated in the industrial models, or the coin slot key or CP of the professional models is removed, the machine automatically leaves “Credit mode”. If the machine is in a secondary screen of the main menu (configuration, maintenance...) and it exits “Credit Mode”, it acts as if it were in this mode until exiting the Main menu (saving the changes). Once the machine has reached the Main screen, it exits credit mode.

7.4 Run Screen

When START is pressed, the programme begins and the *Run Screen* is displayed.

While in run mode, it is also possible to enter “Credit mode” as described above. If this mode is entered, it automatically exits self-service mode and behaves as if it were in OPL mode, displaying the information defined on the *OPL Run Screen* and offering the option to perform all the actions defined on this screen.

In self-service mode, the option to forward or pause the programme does not exist unless “Credit mode” is entered.

Nor is the STOP button for aborting a programme there by default, although it can be activated using the HUD.

If the STOP button is pressed, there is a grace period during which it is possible to abort a programme without losing the credit inserted. If the programme is aborted twice during the grace period, the credit will be lost.

At the end of the grace period, to abort the programme it is necessary to hold the button down for 3 seconds, and any credit will be lost.

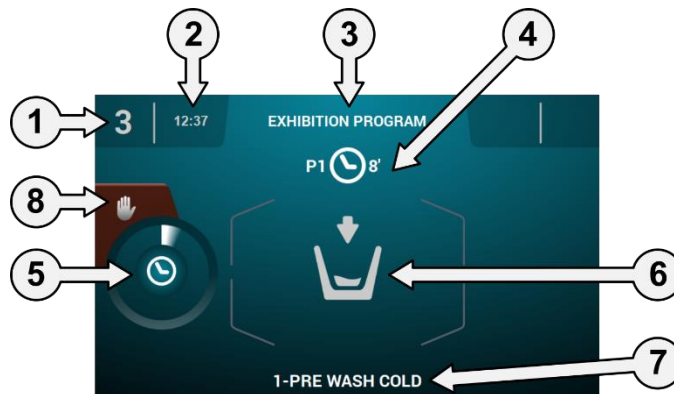

1. **Machine identifier:** Label identifying the machine.
2. **Time:** Time and minutes in the selected format.
3. **Programme name:** Name configured for the selected programme.
4. **Programme number and length:** Position of the programme in the list of programmes (My Programmes), and the estimated length in minutes for the programme selected.
5. **Programme progress indicator:** Status of programme progress, relation between total time and time remaining for programme.
6. **Status (drawing):** Animated drawing showing the current cycle of the washing machine (filling, draining, washing, rinsing, spinning or untangling).
7. **Currently running cycle:** Identifier and name of currently running cycle.
8. **Stop** (default setting disabled): Button to stop and cancel the programme. A confirmation message will be requested.

8 PROGRAMMES

There is a programme library consisting of all the programmes installed by default, together with the programmes created by the user.

8.1 Programme library

These are the programmes that are found by default in the programme library:

- P1: Fast cold wash
- P2: Fast wash 30°C (86°F)
- P3: Fast wash 60°C (140°F)
- P4: Fast delicates

P1					
	8	2	2	2	6
	1	3	3	3	
	3	3	3	3	4
	0	0	0	0	
	15;05	15;05	15;05	15;05	
	✓	✓	✓	✓	
	✓	✓	✓	✓	
	✓	✓	✓	✓	
					✓
					✓
D	D2, D3			D4, D5	

P2					
	8	2	2	2	6
	30				
	1	3	3	3	
	3	3	3	3	4
	1	0	0	0	
	15;05	15;05	15;05	15;05	
	✓	✓	✓	✓	
	✓	✓	✓	✓	
	✓	✓	✓	✓	
					✓
					✓
D	D2, D3			D4, D5	

P3					
	8	2	2	2	6
	60				
	1	3	3	3	
	3	3	3	3	4
	1	0	0	0	
	15;05	15;05	15;05	15;05	
	✓	✓	✓	✓	
	✓	✓	✓	✓	
	✓	✓	✓	✓	
					✓
					✓
D	D2, D3			D4, D5	

P4					
	8	2	2	2	6
	2	4	4	4	
	2	2	2	2	3
	0	0	0	0	
	08;06	08;06	08;06	08;06	
	✓	✓	✓	✓	
	✓	✓	✓	✓	
	✓	✓	✓	✓	
					✓
					✓
D	D2, D3			D4, D5	

9 CONFIGURATION

9.1 Programme management

If the washing machine is configured in self-service mode, only the first 16 programmes will be available, the remaining programmes become available on entering Credit Mode”.









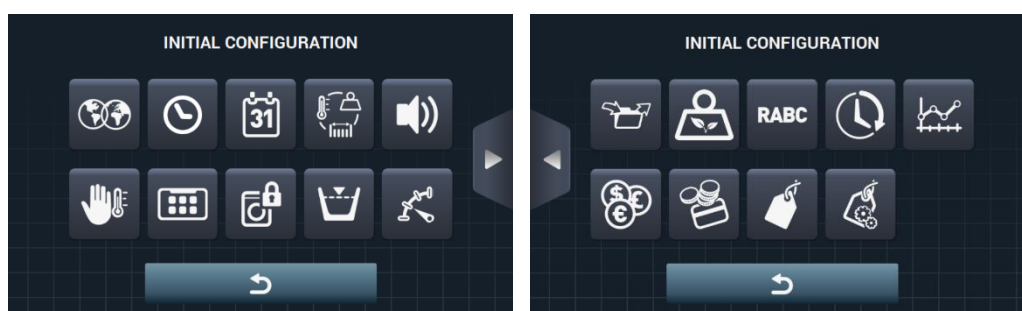

9.2 Configure System

9.2.1 Advanced configuration







Access: [Main screen]  ⇒ [Main Menu] 

The following sections can be configured in the system configuration, as in “Credit mode” (See section 4.2):



-  **Next screen.**
-  **Previous screen.**
-  **Language:** The washing machine texts can be displayed in 34 different languages, although the texts can only be edited using Western character sets.
-  **Time:** Configuration of the current time. The display format (12 hour / 24 hour (default setting)) can be selected.
-  **Date:** Configuration of the current date. The display format (dd/mm/yyyy (default setting) / yyyy/mm/dd / mm/dd/yyyy) can be selected.
-  **Units of measurement:** The unit of measurement in which the temperature (°C (default setting) or °F), the weight (Kg (default setting) or lb) and the size (mm (default setting) or in) can be selected.
-  **Thermal stop:** General configuration of the thermal stop. If this is disabled, the thermal stop does not take place even if this parameter is active in the currently running cycle. If, however, it is enabled, the configuration of each cycle is respected and the consequent action is taken. By default it is active.
-  **Water saving by weight:** The required water saving for the weight can be configured. Three different weight options and three levels of saving can be selected. Depending on the load, there will be a reduction in the water level and detergent dose.
-  **Levels:** This enables the configuration in mm of the 5 configurable levels. Each level type will have a default value and configuration range. These values will depend on the model selected. (See table of levels by model).
-  **Speed:** This enables the configuration in RPM of the different types of speed existing, in both the wash and spin cycles. Each speed type has a minimum and maximum configuration value. (See table of RPM/V equivalences by model).

Translation of original instructions.

- 
Import/Export Configuration: It is possible to import a machine configuration from a USB memory stick or to export the current machine configuration to a memory stick. When this button is pressed, an intermediate window is displayed where we select whether to import or export (as in programmes).
- 
Credit Mode: If the washing machine is in self-service mode, the password for Credit Mode (1234 by default) can be configured. Make a note of the password in a safe place. If you lose it, please contact the technical support service.
- 
HUD: In self-service mode, it is also possible to configure the *Main screen* (first and second selection screens) and the *Run screen*. (See section 9.2.2).
- 
Beep: Option permitting the buzzer to be disabled. By default it is enabled.
- 
RABC/Traceability: The information for each wash is registered, and the information saved (see section 4.2).
- 
Grace Period: When this button is pressed, an intermediate screen is displayed from where it is possible to activate or deactivate the grace period and edit the value between 1 and 99 minutes (the default setting is enabled and 1 minute).

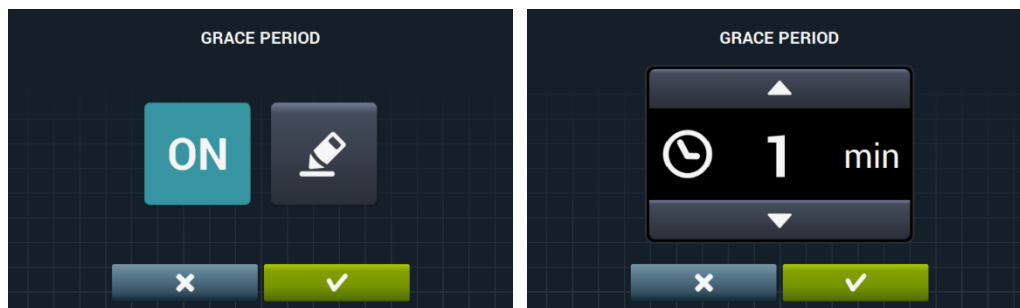

- 
Self-service statistics: This provides data about payments and the number of times each of the favourite programmes is run. When the self-service statistics button is pressed, the following screen is displayed.

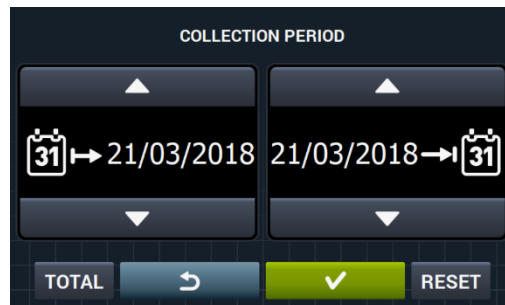



Press "TOTAL" to display the total values for the machine. If a date is entered, the statistics are only shown for this period. Press "Reset" to set all the values to 0, resetting the statistics.





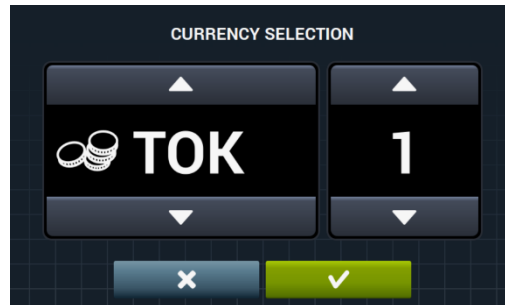

EXECUTIONS AND COLLECTED MONEY		
1 FAST COLD	0	0.00€
2 FAST 30°C	0	0.00€
3 FAST 60°C	0	0.00€
4 FAST DELICATE	0	0.00€
TOTAL	0	0.00€

- 
Currency: This allows you to select the type of currency in which you wish to work and to modify its pulse value (see section 9.2.3). If the currency is changed, all the prices will be reset, by default to token.

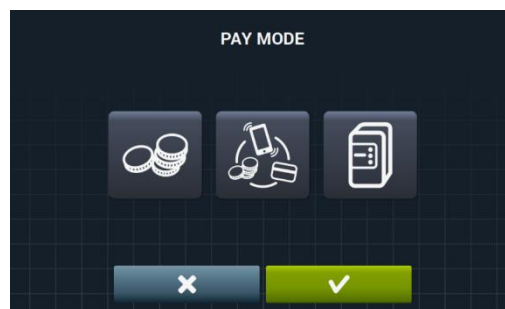

- 
Payment Method: There are 3 different modes for operating in self-service mode.





- 
COIN: The currency and price of each programme must be configured, using the coin slot pulses to enable a set programme to be run.
 - 
Central Payment: The washing machine receives a pulse from a payment centre to release the washing machine and permit a programme to be run. Default setting. The currency, price and price programming options are disabled.
 - 
Multipayment: Same compartment as the "COIN" option.
- 
Prices: The prices of all the selected programmes can be configured in "My Programmes". The minimum value of the programme will be the multiple defined in the currency, and the maximum will be 100 times the value of the multiple. The default setting is the minimum configurable value.

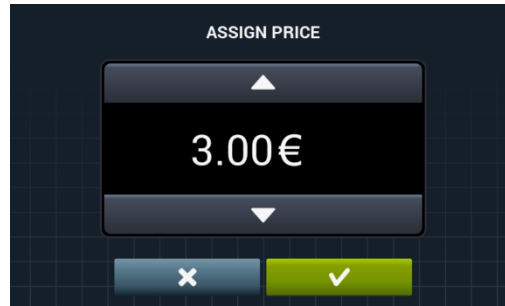

ASSIGN PRICES	
1 FAST COLD	3.00 €
2 FAST 30°C	4.00 €
3 FAST 60°C	5.00 €
4 FAST DELICATE	3.00 €

Select the programme or programmes to be modified and press  to go to the window to allocate the new price.



-  **Price programming:** In addition to the basic price configuration, it is possible to define a price programming. That is, periods of specific time for which you wish to change the defined programme price. Maximum, 10 simultaneous programmings.

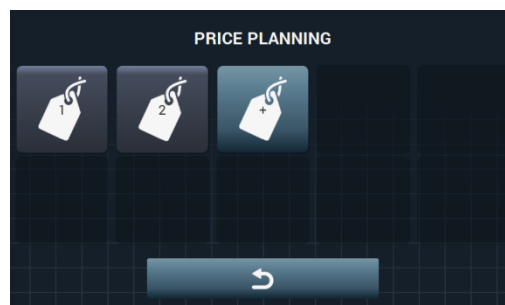

The programmed prices are valid for the configured time slot. The prices return to the general prices outside the configured time slot.

If there is a conflict between different programmings, the condition of the first plan will be applied. In addition, plans can only be created from the current date.

When  is pressed, a new plan is created. These are the fields that must be completed when preparing a programming:

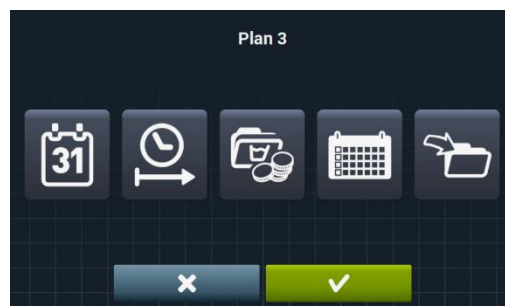

-  **Date:** Time period in which programming is to be made.

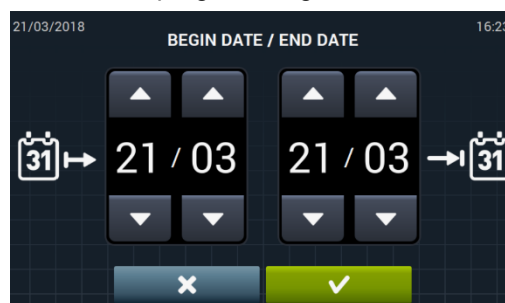

-  **Start/end time:** Start and end time of the programming.

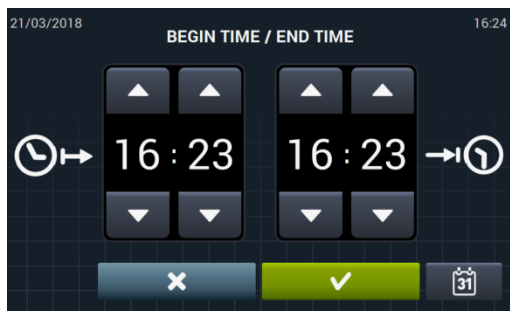

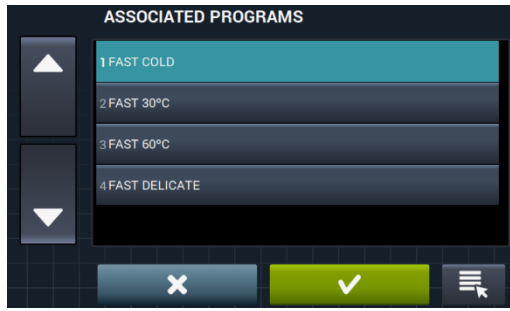

-  **Programme(s) & Prices:** Price or discount to be allocated to each of the existing programmes in “My Programmes”.
A set price can be allocated or a discount applied to the selected programmes.

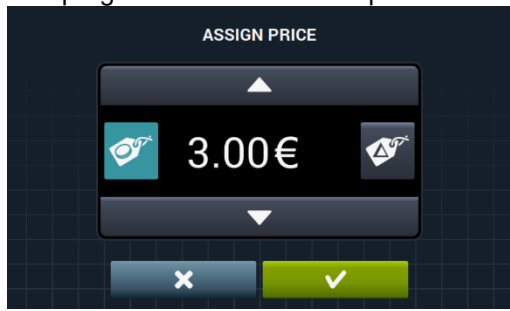

Select the programme or programmes to which the price variation is to be applied, and press OK.



-  **Set price:** The set price will be applied to all the programmes we have selected.
-  **Discount:** The discount defined will be applied to all the programmes we have selected.
-  **Calendar:** Within the selected time period, days on which the programming is to be applied.

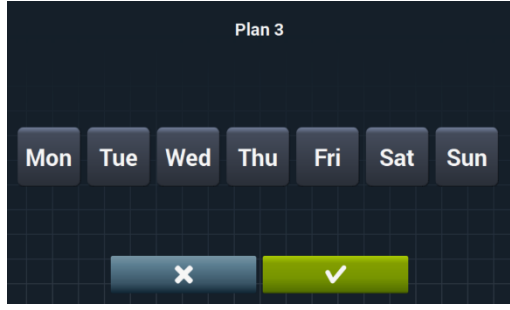

- 
Import: In addition to entering the fields one by one, it is also possible to import an existing plan from a USB memory stick.

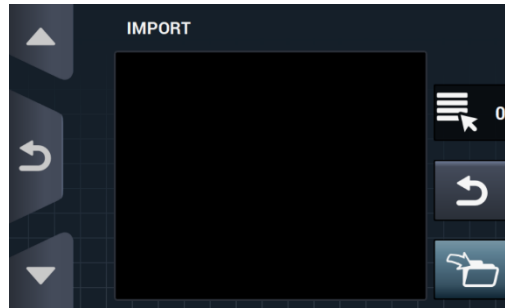

If IMPORT is selected, the same screen as in programmes is displayed in order to browse through the USB, but only plan files (with extension .plan) can be selected. It is only possible to import one plan when importing.

On pressing OK and importing the plan, the display returns to the main window of price plans.

On pressing the button for one of the active plans , a summary of the configured parameters is displayed.

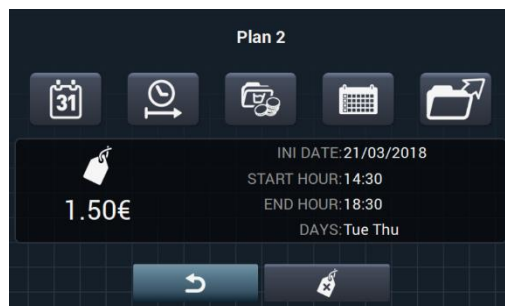

The parameters described above can be changed one by one by pressing the corresponding button.

In addition, there is an “Export”  button for exporting this plan (in a file with a .plan extension) to the root directory of the USB memory stick.

The price plan sheets are saved in a folder called “PRICE PLANS” in the USB root directory.

Each price plan sheet is named in the format: PLAN_No_Date_time.plan (PLAN_3_20151029_112346.plan for example).

The plan can be eliminated by pressing the delete button .

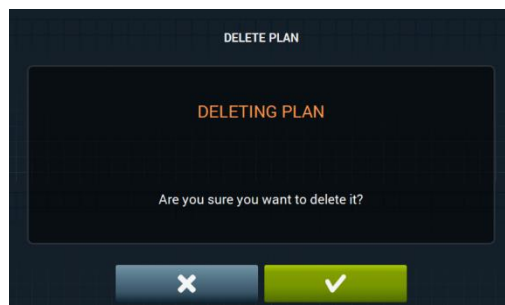

9.2.2 HUD programming

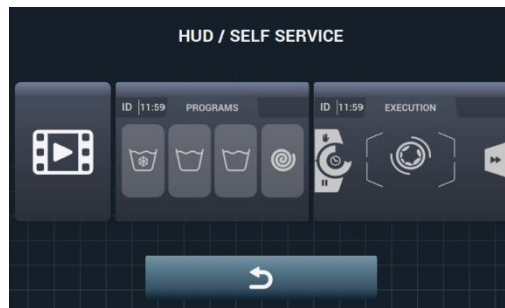

- 
Main Screen: This applies to both self-service selection screens. This allows the following parameters to be configured:



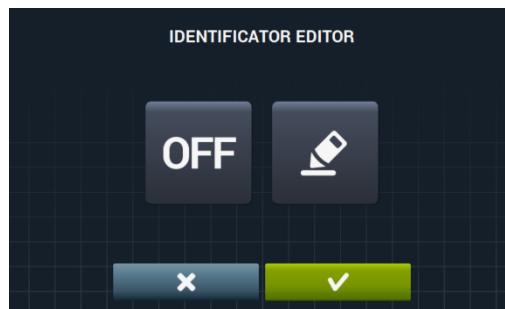

- 
Machine identifier: The machine identifier can be enabled/disabled and configured. By default it is disabled.







The machine identifier is enabled by pressing "OFF"  followed by the edit button .





- 
Time: Display/hide current time. By default it is enabled.

-  **Run Screen:** The configurable options are listed below:

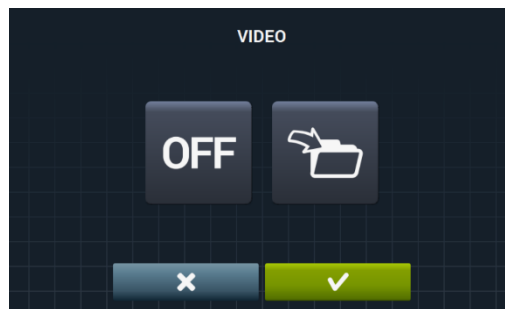

-  **Time:** Option permitting time to be displayed/hidden. By default it is enabled.
-  **Remaining time:** Option to display/hide the total time remaining and the programme progress indicator. By default it is enabled.
-  **Machine identifier:** The machine identifier can be enabled/disabled. By default it is disabled.
-  **STOP:** This allows the stop button to be displayed. By default it is disabled.
-  **Import video:** This permits a video to be played on the machine screen after 10 minutes of inactivity. If "Energy saving" is activated, the video is automatically stopped.



Press import , to import a video to the machine from an external USB flash drive. Only video files (avi, mov...) can be imported, and only one video file can be installed on the machine. The recommended resolution of the videos is 480x272 pixels for machines with a 4.3" screen, and 800x480 pixels for 7" screens. The 16 Fps should not be exceeded. The maximum file size must not be more than 25 Mb.

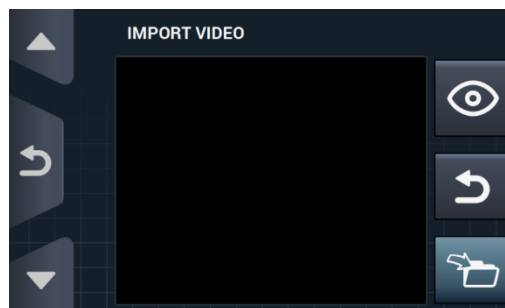

The preview button , allows you to check the video file plays correctly.

9.2.3 Table of currencies

This is the table of all the currencies available with the corresponding symbol and pulse (multiple). If a pulse value is selected other than the default value, the coin slot must be adjusted to this value. This is the responsibility of the user. By default, the coin slots supplied are configured with these values:

COUNTRY	CURRENCY	SYMBOLS	SYMBOL	Value /PULSE
Token	Token	TOK	\$	1
Kuwait	Kuwaiti Dinar	KWD	د.ك	0,05
Oman	Omani Rial	OMR	ر.ع.ر	
Azerbaijan	Manat	AZN	m	0,1
Bulgaria	Lev	BGN	лв	
Bahrain	Bahraini Dinar	BHD	د.ب.	
China	Chinese Yuan	CNY	¥	
Malaysia	Ringgit Malayo	MYR1	RM	
Panama	Panamanian Balboa	PAB	B	
Argentina	Argentine Peso	ARS	\$	
Bermuda	Bermudian Dollar	BMD	BD\$	
Brazil	Real	BRL	R\$	
Canada	Canadian Dollar	CAD	C\$	
Egypt	Egyptian Pound	EGP	ج.م	
Ethiopia	Ethiopian Birr	ETB	Br	
Guatemala	Quetzal	GTQ	Q	
Cayman Islands	Cayman Islands Dollar	KYD	\$	
Saudi Arabia	Saudi Riyal	SAR	ر.س	
El Salvador	Salvadoran Colon	SVC	¢	
Turkey	Turkish Lira	TRY	YTL	
United States	US Dollar	USD	\$	
United Arab Emirates	UAE Dirham	AED	د.إ.	
Bolivia	Boliviano	BOB	Bs	
Estonia	Estonian Kroon	EEK	EEK	
Euro-Countries	Euro	EUR	€	
United Kingdom	Pound sterling	GBP	£	
Georgia	Lari	GEL	ლარი	0,5
Ghana	Ghanaian Cedi	GHS	GHS	
Croatia	Croatian Kuna	HRK	kn	
New Zealand	New Zealand Dollar	NZD	\$	
Qatar	Qatari Riyal	QAR	ر.ق.	
Ukraine	Ukrainian Hryvnia	UAH	\$	
Singapore	Singapore Dollar	SGD	S\$	
Malaysia	Malaysian Ringgit	MYR	RM	

Bosnia and Herzegovina	Convertible Mark	BAM	KM	1
Bangladesh	Bangladeshi Taka	BDT	Tk	
Switzerland	Swiss Franc	CHF	CHF	
Dominican Republic	Dominican Peso	DOP	RD\$	
Hong Kong	Hong Kong Dollar	HKD	HK\$	
Israel	Israeli Shekel	ILS	₪	
India	Indian Rupee	INR	Rs.	
Sri Lanka	Sri Lankan Rupee	LKR	₹	
Morocco	Moroccan Dirham	MAD	د.م.	
Macedonia	Macedonian Denar	MKD	MKD	
Peru	Peruvian Nuevo Sol	PEN	S/.	
Poland	Polish Zloty	PLN	zł	
Russian Federation	Russian Ruble	RUB	руб	
Sweden	Swedish Krona	SEK	kr	
Thailand	Thai Baht	THB	฿	
Tunisia	Tunisian Dinar	TND	د.ت.	
Uruguay	Uruguayan Peso	UYU	\$	
Serbia	Serbian Dinar	RSD	дин.	
South Africa	South African Rand	ZAR	R	
Australia	Australian Dollar	AUD	\$	
Czech Republic	Czech Koruna	CZK	Kč	5
Denmark	Danish Krone	DKK	kr	
Kenya	Kenyan Shilling	KES	KSh	
Mexico	Mexican Peso	MXN	\$	
Norway	Norwegian Krone	NOK	kr	
Romania	Romanian Leu	RON	L	
Philippines	Philippine Peso	PHP	\$	10
Algeria	Algerian Dinar	DZD	د.ج.	
Guyana	Guyanese Dollar	GYD	GY\$	
Hungary	Hungarian Forint	HUF	Ft	
Iceland	Icelandic Krona	ISK	kr	
Kazakhstan	Kazakhstan Tengue	KZT	T	
Taiwan	Taiwanese Dollar	TWD	NT\$	50
Chile	Chilean Peso	CLP	\$	
Costa Rica	Costa Rican Colon	CRC	₡	
Iran	Iranian Rial	IRR		
Paraguay	Paraguayan Guarani	PYG	\$	
French Polynesia	French Pacific Franc	XPF	F	100
Colombia	Colombian Peso	COP	\$	
Indonesia	Indonesian Rupee	IDR	Rp	
Japan	Japanese Yen	JPY	¥	
South Korea	Korean Won	KRW	₩	
Uganda	Ugandan Shilling	UGX	USh	
Venezuela	Venezuelan Bolivar	VEF	Bs.	

10 MAINTENANCE

10.1 Errors

The errors with different actions for Self-service are listed below. The others are the same.

ERROR	DESCRIPTION	CAUSE AND ACTION
E6	HEATING FAULT	<p>The machine detects that, in spite of activating the heating output, the water temperature has not increased within 30 minutes.</p> <p>It is possible to cancel this error. In this case, instead of triggering an error, the machine will continue running as if the temperature had been reached.</p> <p>A warning is displayed but the machine does not stop. It continues with the programme but the warning remains until the programme ends and the door is opened.</p>
E9	UNBALANCED LOAD	<p>In the final spin distribution, the input "Unbalanced load switch" is activated 5 times.</p> <p>An error is not triggered and the machine spins at low speed. The programme ends normally without warnings.</p>

ADVERTENCIAS DE SEGURIDAD.....	2
1 USO	5
1.1 Recomendaciones de uso.....	5
1.2 Uso del dosificador.....	5
1.3 Características de la máquina	5
2 INTERFACE.....	6
2.1 Pantalla OFF OPL.....	6
2.2 Pantalla principal OPL.....	6
2.3 Pantalla ejecución OPL	7
3 PROGRAMAS	10
3.1 Parámetros de fase.....	10
3.1.1 Parámetros para fases de remojo, prelavado, lavado o aclarado:.....	10
3.1.2 Parámetros para fases de centrifugado:.....	12
3.2 Biblioteca de fases	13
3.3 Biblioteca de programas	15
4 CONFIGURACION	16
4.1 Gestión de programas	17
4.1.1 Mis programas (favoritos).....	17
4.1.2 Biblioteca de programas	18
4.1.3 Biblioteca de fases.....	21
4.2 Configurar Sistema.....	22
4.2.1 Configuración HUD.....	26
5 MANTENIMIENTO.....	30
5.1 Irregularidades eléctricas y mecánicas	30
5.2 Avisos	30

ADVERTENCIAS DE SEGURIDAD

Para reducir el riesgo de descargas eléctricas o lesiones personales al usar su aparato, siga las precauciones básicas, incluyendo las siguientes:

- **LEA** todas las instrucciones antes de usar el aparato y **GUARDELAS** en lugar fácilmente accesible para solventar cualquier duda.
- **NO** lave prendas que hayan sido previamente tratadas, lavadas, remojadas o manchadas con gasolina, disolventes de limpieza en seco, u otras sustancias inflamables o explosivas, ya que despiden vapores que pueden incendiarse o explotar.
- **NO** agregue gasolina, disolventes de limpieza en seco, o otras sustancias inflamables al agua de lavado. Estas sustancias emiten vapores que pueden incendiarse o explotar.
- En determinadas condiciones, el gas de hidrógeno puede ser producido en un sistema de agua caliente que no se ha utilizado durante dos semanas o más. Gas hidrógeno es explosivo. Si el sistema de agua caliente no ha sido usado por un período, antes de usar la lavadora, abra todos los grifos de agua caliente y deje que el agua de cada uno corra durante varios minutos. Esto liberará el gas hidrógeno acumulado. Como el gas es inflamable, no fume ni use una llama durante este tiempo.
- Este aparato pueden utilizarlo niños con edad de 8 años y superior y personas con capacidades físicas, sensoriales o mentales reducidas o falta de experiencia y conocimiento, si se les ha dado la supervisión o formación apropiadas respecto al uso del aparato de una manera segura y comprenden los peligros que implica.

La limpieza el mantenimiento a realizar por el usuario no deben realizarlo los niños sin supervisión.

- NO permita que los niños jueguen en o sobre el aparato. Mantenga a los niños bajo estricta vigilancia cuando se encuentren en las proximidades de una maquina en funcionamiento. Los niños de menos de 3 años deberían mantenerse apartados salvo continua supervisión.
- Quite la puerta antes de desechar el aparato o dejarlo fuera de servicio.
- NO INTENTE ABRIR LA PUERTA si el tambor está en movimiento.
- NO instale ni almacene el aparato a la intemperie.
- NO trate de forzar los controles.
- Se deben utilizar mangueras nuevas suministradas con el aparato, no utilizar manqueras viejas.
- No repare o reemplace ninguna pieza del aparato ni intente ninguna operación de servicio a menos que se recomiende en el manual de instrucciones de usuario. Aun así asegúrese siempre de entender perfectamente las instrucciones y tenga las habilidades necesarias para llevar a cabo la operación.
- NO eliminar ningún dispositivo de seguridad ni modificar ningún elemento de la lavadora. NO INSTALAR en el interior de la maquina elementos ajenos a ella.
- Cualquier omisión de las indicaciones descritas en los manuales de instrucciones, pueden ocasionar daños personales al usuario. No es posible cubrir todas las condiciones y situaciones posibles con los avisos de peligro y advertencias. Por lo tanto, el sentido común,

precaución y el cuidado son factores que deben ser aportados por la(s) persona(s) que transporte, instale, utilice o mantenga la máquina.

- NO utilizar la maquina sin estar todas las tapas y protecciones correctamente colocadas y fijadas.
- ES OBLIGATORIO la instrucción correcta del usuario por parte del distribuidor (vendedor) durante la puesta en marcha.
- Aporte a las cubetas correspondientes las dosis de detergente, suavizante y lejía indicadas por el fabricante. Observar los consejos de tratamiento de cada tejido indicados por el fabricante del mismo.
- Limpie diariamente las cubetas de detergente y líquidos. Para la limpieza use agua y jabón, nunca detergentes abrasivos.
- Limpie mensualmente los filtros de las entradas de agua y los conductos de dosificación exteriores.
- No lave nunca el exterior utilizando chorro de agua; pueden estropearse las partes funcionales de la máquina.
- Si la lavadora no va a utilizarse en un período de tiempo largo, pase una mano de aceite de vaselina sobre todas las superficies de acero inoxidable.
- Se recomienda una revisión general anual.

1 USO

1.1 Recomendaciones de uso

Esta máquina está diseñada y concebida para el lavado o tratado de textiles en general. Su empleo en propósitos ajenos a lo indicado será considerado como indebido y peligroso.

Es aconsejable cargar la maquina con su carga nominal, evite meter cargas muy inferiores o superiores.

No es aconsejable lavar ropa introducida en sacos, en tal caso, llene la lavadora hasta su carga nominal para evitar posibles desequilibrios de carga.





No es aconsejable centrifugar lonas o prendas impermeables, mopas, moquetas o alfombras.

Antes de intentar abrir la puerta espere a que el tambor se haya detenido. Por motivos de seguridad la puerta no se desbloquea hasta unos segundos después de haber terminado el programa.

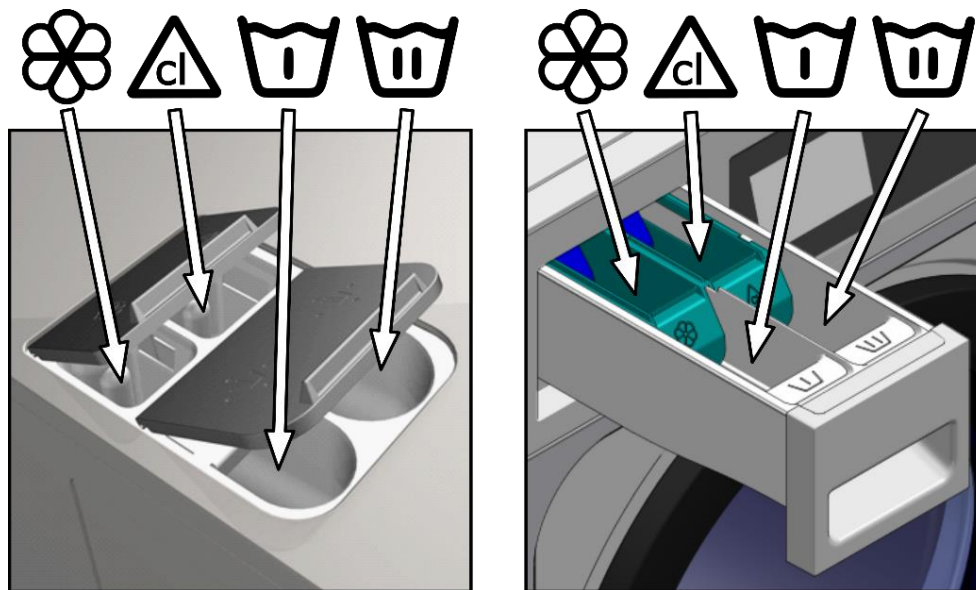
1.2 Uso del dosificador

Añadir los productos de lavado en cada compartimento y cerrar la tapa del dosificador.



-  Detergente en polvo para prelavado
-  Detergente en polvo para lavado
-  Suavizante líquido
-  Blanqueador líquido (lejía)

1.3 Características de la máquina

El control de la maquina se realiza mediante un microprocesador programable capaz de adaptarse a las necesidades de cada usuario.

Dispone de control inteligente para la regulación de temperatura, si dispone de agua caliente, conéctela. La lavadora gestionará las diferentes entradas de agua para mantener la temperatura programada.

Dispone de control inteligente para la gestión del centrifugado. La lavadora controla el desequilibrio generado por la carga y gestiona el giro para garantizar un buen centrifugado, sin ruidos y alargando la vida útil de los elementos de desgaste y así como una significativa reducción de fatiga en los componentes mecánicos.

2 INTERFACE

Todas las lavadoras llevan una pantalla táctil donde además de visualizar toda la información permite la selección de todos los controles que se muestren en pantalla.

Cuando se alimente la máquina irá a la *Pantalla Off*. El botón ON/OFF llevará a la *Pantalla principal*, desde aquí se puede poner en marcha un programa o acceder al menú principal. Pulsando START llevará a la *Pantalla ejecución*, mostrando en pantalla toda la información relevante del mismo.

Pulsando ON/OFF llevará de vuelta a la *Pantalla Off* desde la pantalla en el que se encuentre.

La información que aparece en cada una de las pantallas puede ser omitida o habilitada desde el menú HUD (Ver apartado 4.2.1)

2.1 Pantalla OFF OPL

Es la pantalla que se visualiza cuando la lavadora esté apagada, mostrando los parámetros configurados por el usuario

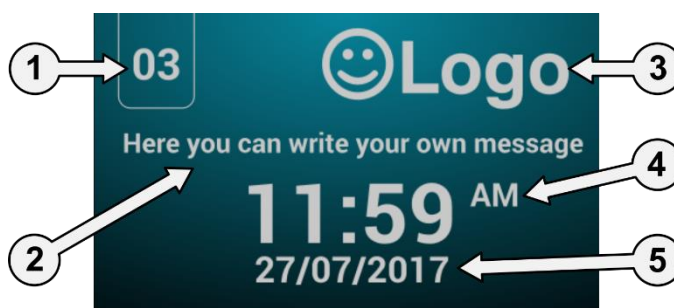

1. **Identificador de máquina:** Etiqueta que identifica la máquina (si está habilitado)
2. **Mensaje lavandería:** Mensaje configurado por el usuario (si está habilitado)
3. **Logo:** Se mostrará el logo (si está habilitado)
4. **Hora:** Horas y minutos en el formato seleccionado.
5. **Fecha:** Fecha en el formato seleccionado (si está habilitado en HUD)

Si la opción “ahorro energético” está activo, al de 10 minutos de apagar la lavadora se apagará el backlight de la pantalla. Si se toca en cualquier parte de la pantalla el backlight será encendido de nuevo.

2.2 Pantalla principal OPL

La *Pantalla principal* de la lavadora es la siguiente, en la que se define cada una de las opciones disponibles. Algunas de las opciones pueden ser omitidas desde el menú HUD.



1. **Identificador de máquina:** Etiqueta que identifica la máquina.
2. **Hora:** Horas y minutos en el formato seleccionado.
3. **Peso ropa:** Se visualizará el peso de la ropa introducida (si kit de pesado está activo) o la carga nominal del modelo seleccionado (si el kit no está activo), pudiendo editar el peso de la carga introducida. Posibilidad de habilitar/omitir en HUD. Una vez terminado o abortado el programa, se volverá a seleccionar la carga nominal de la máquina.
4.  **Menú principal:** Acceso al menú principal de la lavadora, donde se podrán gestionar diferentes parámetros de la máquina.
5. **Nombre de programa:** Nombre configurado para el programa seleccionado.
6. **Temperatura programa:** Temperatura máxima entre las diferentes fases que contiene el programa.
7. **Número y duración de programa:** Posición del programa en la lista de programas (Mis Programas), y la duración, en minutos, estimada para el programa seleccionado.
8. **Incremento/decremento programa:** Permiten avanzar o retroceder en la lista de programas seleccionados. Además de con los botones, se podrá incrementar/decrementar el programa, pulsando directamente en la información del programa (la que se encuentra encima del botón).
9. **Start:** Botón para comenzar la ejecución del programa seleccionado desde la fase indicada.
10. **Fases programa:** Pulsando en icono del programa seleccionado, se mostrarán las fases que componen el programa, pudiendo seleccionar la fase por el que se quiere comenzar. Asimismo, existirá la posibilidad de realizar una programación instantánea, esto es, cambiar los parámetros que componen una fase (tiempo, temperatura, nivel y dosificación) para la ejecución en curso, valores que no serán guardados para futuras ejecuciones.

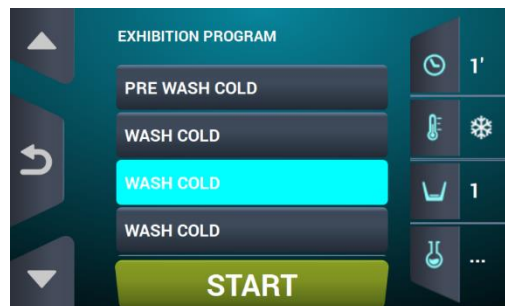

2.3 Pantalla ejecución OPL

Al pulsar el botón START, comienza el programa y se muestra en pantalla toda la información relevante del mismo. Algunas de las opciones pueden ser omitidas desde el menú HUD.

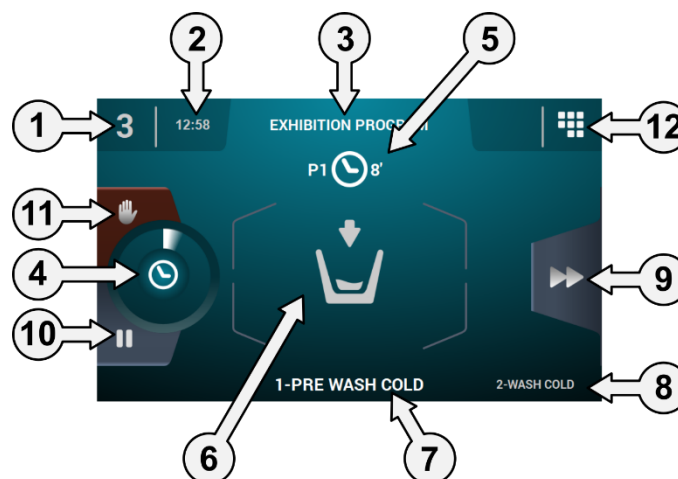

1. **Identificador de máquina:** Etiqueta que identifica la máquina.
2. **Hora:** Horas y minutos en el formato seleccionado.
3. **Programa en ejecución:** Nombre de programa, Número de programa, Duración programa.
4. **Indicador de progreso de programa:** Estado del progreso del programa, relación entre el tiempo total y el tiempo restante del programa.

- 5. **Número y duración de programa:** Posición del programa en la lista de programas (Mis Programas), y la duración, en minutos, estimada para el programa seleccionado.
- 6. **Estado (dibujo):** Dibujo animado que muestra lo que está realizando la lavadora (llenando, vaciando, lavando, aclarando, centrifugando o desapelemazando).

	Abriendo puerta.		Basculación frontal.
	Calentando		Basculación posterior.
	Desapelemazado.		Centrifugando.
	Enfriando.		Finalizando.
	Llenando.		Lavando.
	Parando.		Parada programada.
	Sacando ropa.		Vaciando.

- 7. **Fase en ejecución:** Identificador y nombre de la fase en ejecución.
- 8. **Siguiente fase:** Identificador, nombre y dibujo de la fase que viene a continuación (En caso de que sea la última fase no se mostrará nada).
- 9. **Avance fase:** Botón que permite avanzar a la fase siguiente (En caso de que sea la última fase no se mostrará nada). Además de con el botón, se podrá avanzar la fase pulsando directamente en la información de la siguiente fase (la que se encuentra encima del botón).
- 10. **Pause:** Botón que permite hacer una parada en el programa en ejecución. Si se pausa el programa, cambiará del icono de pause al de play, pudiendo reanudar el programa desde donde ha sido interrumpido.
- 11. **Stop:** Botón para abortar el programa. Se pedirá mensaje de confirmación.
- 12. **Menú ejecución:** Acceso a los parámetros en curso.



- **Entradas:** Se visualiza el estado de todas y cada una de las entradas. Las entradas que estén disponibles en TODAS las máquinas se mostrarán SIEMPRE. Las entradas exclusivas de alguna prestación (por ejemplo, Autoservicio, Sanitario, Dosificadores extra, Tanques (T1, T2, T3), Basculación...) estarán disponibles solamente si la prestación está activada.

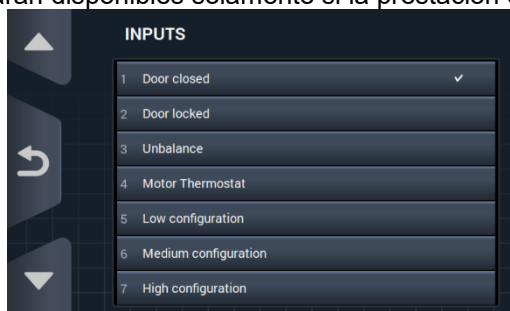

- 
Salidas: Se visualiza el estado de todas y cada una de las salidas. Las salidas que estén disponibles en TODAS las máquinas, se mostrarán SIEMPRE. Las salidas exclusivas de alguna prestación (por ejemplo, Autoservicio, Sanitario, Dosificadores extra, Tanques (T1, T2, T3), Basculación...) estarán disponibles solamente si la prestación está activada.

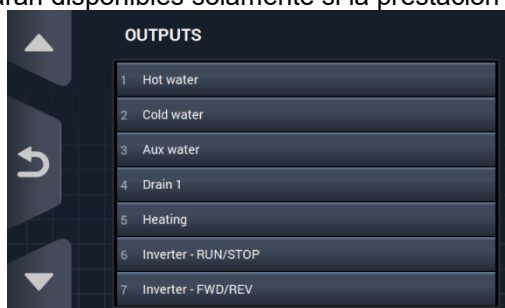

- 
Consignas/valores: Visualización de las consignas y valores reales de la fase en ejecución (Temperatura, Nivel, Tiempo restante). Pulsando sobre los botones de la columna derecha, se puede editar los valores de consigna, teniendo efecto sólo en la ejecución en curso.

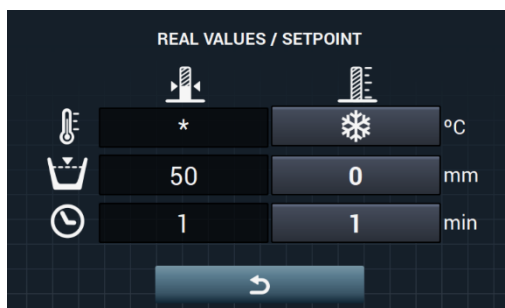

- 
Dosificación manual: Se podrá acceder a este apartado, se visualizará el estado de cada dosificador (ON /OFF) pudiendo activar/desactivar la dosificación deseada. Las opciones disponibles estarán en base a la configuración de kits existente. Al salir de la pantalla de dosificación, se desactivarán todos los dosificadores.

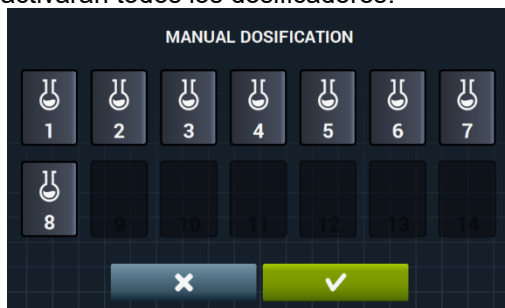

- 
Entrada de agua manual: Se podrá acceder a este apartado, se visualizará el estado de cada entrada de agua (ON / OFF) pudiendo activar la deseada. La entrada de agua que esté activa por el algoritmo de llenado, no se podrá desactivar. Al salir de la pantalla de entrada de agua, se desactivarán todas las entradas de agua activadas manualmente.

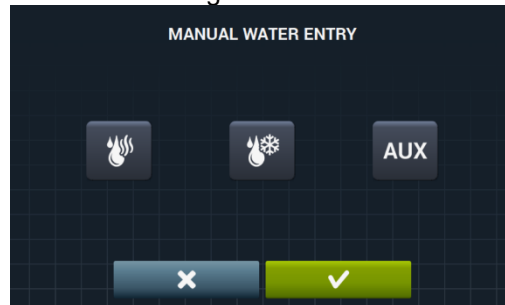

3 PROGRAMAS

Existirá una biblioteca de programas compuesto por todos los programas que llevarán por defecto, así como los programas creados por el propio usuario.





Antes de pasar a explicar la gestión de los programas (ver apartado 4.1), pasaremos a exponer cuáles son sus parámetros y cuáles son los programas estándares que contiene la biblioteca.





3.1 Parámetros de fase

Cada programa estará formado por una serie de fases, las cuales están compuestas por un conjunto de parámetros configurables, dependiendo del tipo de fase del que se trate.

3.1.1 Parámetros para fases de remojo, prelavado, lavado o aclarado:



- Nombre fase:** Nombre que identifica a la fase. No será el texto que se muestre en la *Pantalla de ejecución*, sino el que identifica una fase creada.
- 
Tiempo: Valor, en minutos, de la duración de la fase. Rango configurable de 1 a 99.
- 
Temperatura: Temperatura, °C ó °F, de ejecución de la fase. Rango configurable de 20°C (68°F) a 90°C (194°F).
- 
Nivel: Nivel de agua a la que se deberá ejecutar la fase. Rangos configurables (ver apartado 4.2). Existirán 5 tipos de niveles: Mínimo (1), Bajo (2), Medio (3), Alto (4), Máximo (5)
- 
Velocidad: Velocidad de ejecución de la fase. Rangos configurables (ver apartado 4.2). Existirán 4 tipos de velocidades diferentes a elegir: Mínimo (1), Bajo (2), Normal (3), Alto (4)
- 
Ritmo de lavado: Secuencia de movimiento que tiene que seguir la lavadora (tiempo marcha (seg.) / tiempo parada (seg.)). Rango configurable de 1 a 99. El tambor girará alternando a la izquierda y a la derecha.

- 
Entrada agua: Indica la selección de la entrada de agua deseada.
 - Agua caliente: Carga agua desde la toma de agua caliente (Si/No)
 - Agua fría: Carga agua desde la toma de agua fría (Si/No)
 - Auxiliar: Carga agua desde la toma de agua auxiliar (Si/No)
 - Regulación de agua: Carga agua desde una u otra entrada dependiendo de la temperatura (Si/No).
 - T1, T2, T3: Carga agua de alguno de los tanques si se dispone del KIT recuperador.
- 
Desagüe: Muestra si se debe vaciar el agua cuando finaliza la fase, señalando por cual de las salidas desaguar en caso de tener el kit recuperador de agua activo.
- 
Enfriamiento: Opción que permite enfriar la temperatura en una fase antes de desaguar o pasar a la siguiente fase. Parámetro configurable sólo si la temperatura de la fase es igual o superior a 40°C (104°F). Rango configurable, de 30°C (86°F) a consigna fase. Además de poder seleccionar el valor de enfriamiento, existirá un botón para habilitar o deshabilitar esta opción.
- 
Dosificación 1..8: Cada dosificación podrá ser activada independientemente, teniendo que configurar los siguientes parámetros en caso de ser activada:
 - Inicio: Si la dosificación X está activa, se debe indicar cuando debe comenzar dicha dosificación





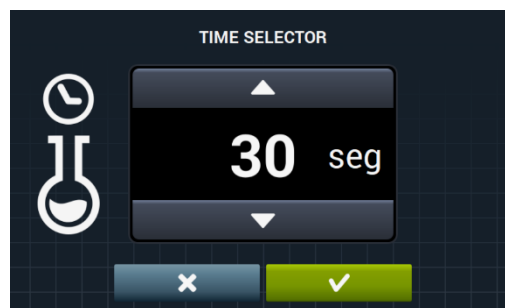

- Nivel seguridad (ML): Comienza a dosificar cuando se alcance el nivel de seguridad.
- Nivel (L): Comienza a dosificar cuando se alcance el nivel definido.
- Temperatura (T): Comienza a dosificar cuando se alcance la temperatura definida.
- Tiempo: Tiempo, en segundos, de la dosificación X. Rango configurable de 0 a 99.

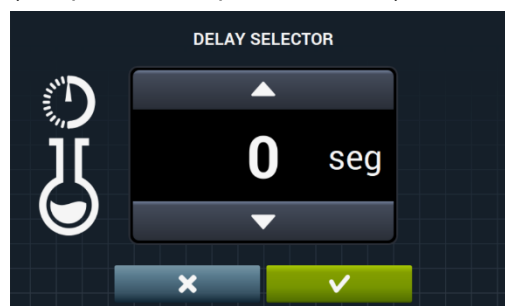







- Retardo: Retardo, en segundos, de la dosificación X. Desde que llegue al punto de inicio indicado, se retarda la dosificación en el tiempo indicado. Rango configurable, de 0 a (tiempo fase-tiempo dosificación).

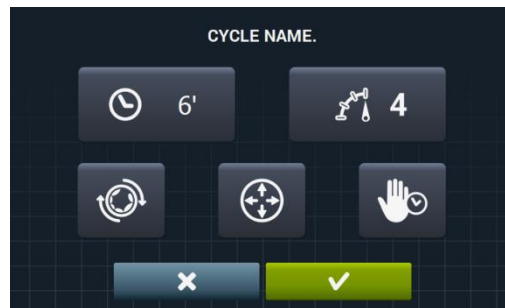

- 
Mover llenando: Giro del tambor mientras está llenando (Si/No).
- 
Movimiento en desagüe: Giro del tambor mientras está vaciando (Si/No).
- 
Parada térmica: Señala el momento a partir del cual empieza a contar el tiempo estipulado para la fase (Si/No).
- 
Parada programa: Permite realizar una parada en el programa antes de que empiece la ejecución de la fase en cuestión. La parada será indicada en la pantalla y se advertirá mediante una señal acústica. (Si/No)
 Si este parámetro está activo, antes de empezar la fase la lavadora pasará al estado pause, indicando en pantalla el mensaje "Pausa programada". Para seguir con la ejecución del programa, deberá de pulsar el botón PLAY.

3.1.2 Parámetros para fases de centrifugado:











- 
Tiempo: Valor, en minutos, de la duración del centrifugado. Rango configurable de 1 a 99.
- 
Velocidad: Velocidad de centrifugado. Existirán 4 tipos de velocidades diferentes a elegir: Mínimo (1), Normal (2), Medio (3), Máximo (4). Valores Medio (3) y Máximo (4) disponibles sólo en caso de lavadoras de altas y medias revoluciones respectivamente. Rango configurable.
- 
Desapelmazado: Desapelmaza al finalizar la fase de centrifugado (Si/No)
- 
Distribución óptima: Si esta opción se encuentra activa, no va a desaguar en la fase anterior.
- 
Parada programa: Permite realizar una parada en el programa antes de que empiece la ejecución de la fase en cuestión. La parada será indicada en la pantalla y se advertirá mediante una señal acústica. (Si/No).

3.2 Biblioteca de fases

Estas son las fases que irán por defecto en la biblioteca de fases, fases que servirán para componer nuevos programas.

- Remojos
 - **F1:** Remojo
- Prelavados
 - **F2:** Prelavado Normal Frío
 - **F3:** Prelavado Normal 40°C (104°F)
 - **F4:** Prelavado Delicado Frío
 - **F5:** Prelavado Delicado 40°C (104°F)
 - **F6:** Prelavado Muy Delicado Frío
 - **F7:** Prelavado Muy Delicado 40°C (104°F)
 - **F8:** Prelavado Wet
- Lavados
 - **F9:** Lavado Normal Frío
 - **F10:** Lavado Normal 60°C (140°F)
 - **F11:** Lavado Normal 90°C (194°F)
 - **F12:** Lavado Delicado Frío
 - **F13:** Lavado Delicado 40°C (104°F)
 - **F14:** Lavado Muy Delicado Frío
 - **F15:** Lavado Muy Delicado 40°C (104°F)
 - **F16:** Lavado Wet Frío
 - **F17:** Lavado Wet 40°C (104°F)
- Aclarados
 - **F18:** Aclarado Normal
 - **F19:** Aclarado Normal Final
 - **F20:** Aclarado Delicado
 - **F21:** Aclarado Delicado Final
 - **F22:** Aclarado Muy Delicado
 - **F23:** Aclarado Muy Delicado Final
 - **F24:** Aclarado Wet
 - **F25:** Aclarado Wet Final
- Centrifugados
 - **F26:** Centrifugado Corto
 - **F27:** Centrifugado Largo

Símbolos de las fases:

	Remojos	
	Prelavados	 : Prelavado frío,  40: Prelavado 40°C (104°F),
	Lavados	...
	Aclarados	 : Aclarado,  : Aclarado final con suavizante
	Centrifugados	

Símbolos y valores de los parámetros:

	Tiempo	Valor en minutos
	Temperatura	Valor en °C (°F)
	Nivel	1:Minimo,2:Bajo, 3: Medio, 4:Alto, 5:Máximo
	Velocidad de lavado	1:Minimo,2:Bajo, 3:Normal, 4:Alto,
	Velocidad de centrifugado	2:Normal, 3: Medio 4:Maximo
	Entrada agua	0:Fría, 1:Fría/Caliente según regulación
	Ritmo de lavado	Tiempo marcha (seg.) ; Tiempo parada (seg.)
	Mover llenando	✓ : Si
	Parada térmica	✓ : Si
	Movimiento en desagüe	✓ : Si
	Desagüe	✓ : Si
	Enfriamiento	✓ : Si
	Distribución óptima	✓ : Si
	Parada programa	✓ : Si
	Desapelmazado	✓ : Si
D	Dosificación	Entrada por donde dosifica (D1: Dosificación 1, ...) con su INICIO/TIEMPO/RETARDO configurado a ML/0/30

Tablas de fases con sus parámetros:

	F1		F2	F3	F4	F5	F6	F7	F8
	3		5	5	6	6	6	6	5
	3			40		40		40	
	3		1	1	3	3	3	3	3
	0		3	3	2	2	2	2	1
	15;05		0	1	0	1	0	1	0
	✓		15;05	15;05	10;08	08;06	5;15	5;15	02;02
	✓		✓	✓					✓
	✓			✓		✓		✓	
				✓		✓		✓	
			✓	✓					✓
			✓	✓	✓	✓	✓	✓	✓
D		D	D1	D1	D1	D1	D1	D1	D1

	F9	F10	F11	F12	F13	F14	F15	F16	F17
	10	10	10	12	12	12	12	10	10
		60	90		40		40		40
	1	1	1	1	1	1	1	2	2
	3	3	3	2	2	2	2	1	1
	0	1	1	0	1	0	1	0	1
	15;05	15;05	15;05	10;08	10;08	05;15	05;15	02;02	02;02
	✓	✓	✓					✓	✓
		✓	✓		✓		✓		✓
	✓	✓	✓					✓	✓
	✓	✓	✓	✓	✓	✓	✓	✓	✓
D	D2, D3	D2, D3	D2, D3	D2	D2	D2	D2	D2	D2

	F18	F19	F20	F21	F22	F23	F24	F25
	2	2	3	3	3	3	2	2
	4	4	4	4	4	4	4	4
	3	3	2	2	2	2	1	1
	15;05	15;05	10;08	10;08	05;15	05;15	02;02	02;02
	✓	✓					✓	✓
	✓	✓					✓	✓
	✓	✓	✓	✓	✓	✓	✓	✓
D		D4		D4		D4		D4

	F26	F27
	2	6
	2	4
	✓	✓
	✓	✓

3.3 Biblioteca de programas

Estos son los programas que irán por defecto en la biblioteca de programas:

P1: Energético 90°C (194°F)	P10: Extra delicado frío
P2: Energético 60°C (140°F)	P11: Económico 90°C (194°F)
P3: Energético 30°C (86°F)	P12: Económico 60°C (140°F)
P4: Energético frío	P13: Económico 30°C (86°F)
P5: Normal 60°C (140°F)	P14: Económico frío
P6: Normal 30°C (86°F)	P15: Sluice
P7: Normal frío	P16: Centrifugado largo
P8: Delicado 40°C (104°F)	P17: Centrifugado corto
P9: Delicado frío	



La tabla de todos los programas con sus parámetros se encuentra en las últimas páginas del manual.

4 CONFIGURACION

A continuación, se muestra el menú principal de configuración de la lavadora, desde donde se pueden configurar diferentes parámetros de la lavadora, así como visualizar o descargar datos que estén almacenados.

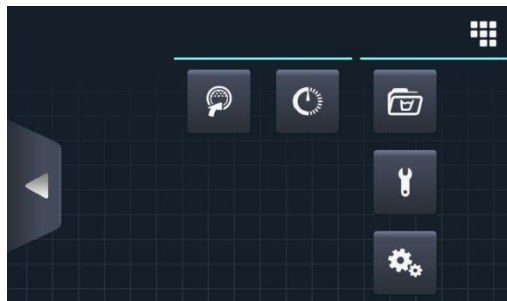
A este menú se accede desde el icono  de la **Pantalla principal** (ver apartado 2.2)





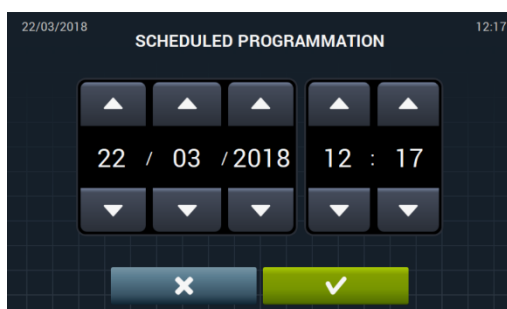

-  **Easy load:** Opción que ayuda a cargar la ropa.
-  **Programación retardada:** Permite retardar un lavado para que se ejecute a la fecha/hora deseada. Una vez se pulsa el botón de "programación retardada", pedirá la introducción de la fecha/hora deseada.

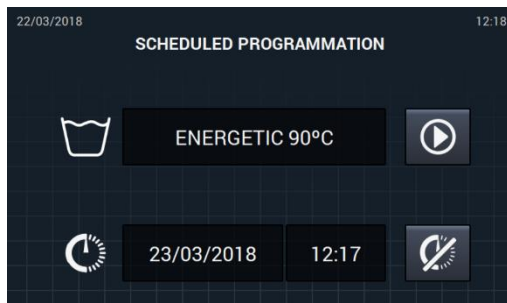

Pasando a una pantalla donde indica la fecha/hora programa, junto al número y nombre del programa.



-  Ejecutar el programa antes de la hora prevista.
-  Cancelar la programación realizada.
-  **Gestión de programas:** Gestión de todos los programas almacenados, así como los programas activos en ese momento. (Ver apartado 4.1)
-  **Configurar sistema:** Configuración de diferentes apartados de la lavadora. (Ver apartado 4.2)
-  **Mantenimiento:** Opciones diversas para el técnico protegido por contraseña.



4.1 Gestión de programas

Desde este submenú se podrán gestionar todos los programas, tanto los que están seleccionados por el usuario como los que se encuentran en la biblioteca. Para ello, habrá que seleccionar entre “Biblioteca de fases”, “Mis programas”, y “Biblioteca de programas”.

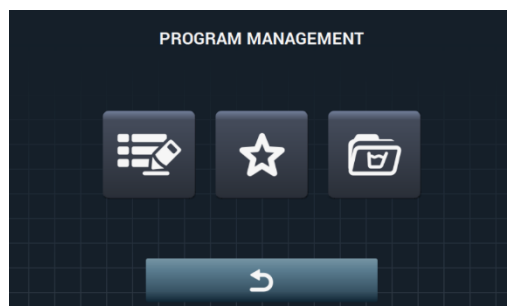
Acceso: [Pantalla principal]  ⇒ [Menu Principal] 





Existirá una biblioteca donde se almacenen todos los programas y fases, programas incluidos por defecto y programas creados/importados por el usuario.

-  **Mis programas:** Disponibles en la Pantalla principal OPL. (Ver apartado 4.1.1)
-  **Biblioteca de programas:** (Ver apartado 4.1.2)
-  **Biblioteca de fases:** (Ver apartado 4.1.3)

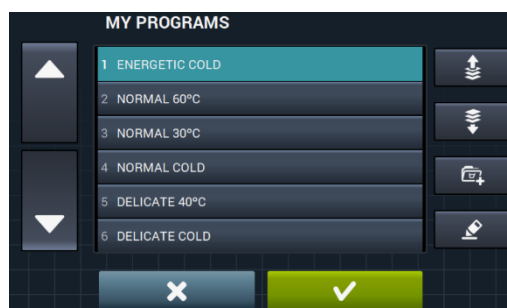

4.1.1 Mis programas (favoritos).

Los programas de la carpeta “Mis programas” son los que van a estar disponibles en la Pantalla principal OPL.

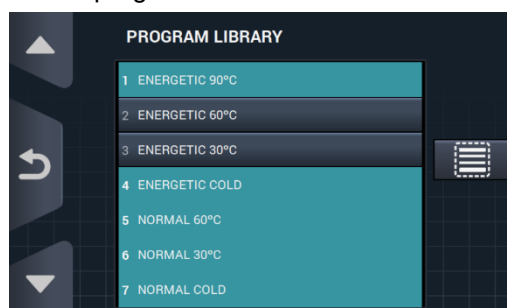

-  **Añadir/quitar programas:** Pulsando iremos a la biblioteca de programas. En esta, estarán resaltados los programas que están incluidos actualmente en “Mis programas” y se podrán seleccionar/deseleccionar uno a uno los programas que queremos añadir/quitar de favoritos.
 -  **Seleccionar/deseleccionar todo:** Selecciona o deselecciona toda la lista de la biblioteca de programas.



-  **“flecha arriba”** y  **“flecha abajo”**: Podremos cambiar de posición cualquier programa de favoritos, pudiendo poner los programas de favoritos en el orden que deseemos.
-  **Botón editar**: Pulsándolo entraremos a modificar el programa seleccionado como si estuviésemos editándolo desde la librería de programas.



Al pulsar OK o Cancel volveremos a Mis Programas.

4.1.2 Biblioteca de programas

Se pueden añadir, copiar, modificar o borrar programas, además de poder importar nuevos programas o exportarlos a una memoria USB externa.

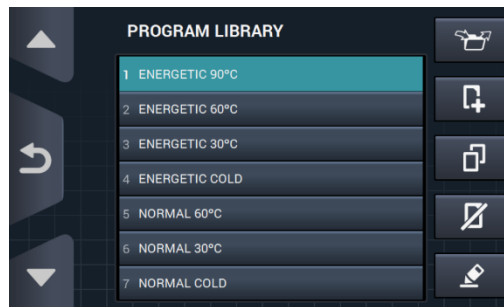

-  **Crear programa**: Creación de nuevos programas de lavado partiendo de las fases existentes en la biblioteca. Al pulsar este botón, lo primero que nos pedirá es introducir el nombre del nuevo programa.

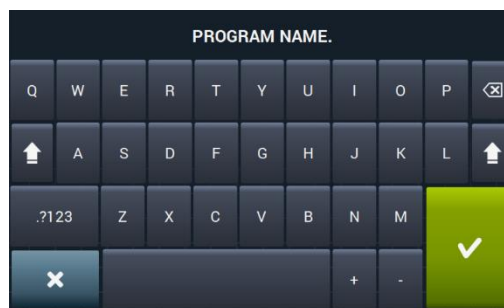

Seguidamente nos mostrará la siguiente pantalla (sin ninguna fase) para poder incluir fases desde la biblioteca de fases.

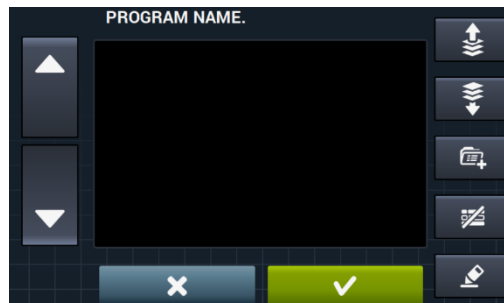







Se podrán añadir fases desde la biblioteca de fases, pudiendo filtrar las fases que se desean visualizar en base al tipo de fase.





Una vez seleccionada la fase, se pueden consultar los parámetros de las fases de la biblioteca antes de incluirlos en el programa que se está creando.





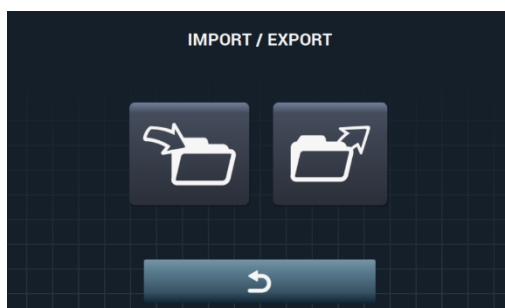

Cada programa será un conjunto de parámetros agrupados por fases que no tendrá relación alguna con las fases existentes en la biblioteca.

- 
Copiar programa: Copia de un programa existente en la biblioteca, asignándole un nombre nuevo.
- 
Modificar programa: Modificación tanto del nombre del programa como de las fases que lo componen, pudiendo añadir, modificar, borrar, o cambiar de orden las fases existentes. Al igual que al crear un nuevo programa, a la hora de modificarlo, se podrán añadir/borrar fases desde la biblioteca de fases. A la hora de crear los programas sólomete se pueden consultar los parametros de las fases, es a la hora de modificar cuando se permite modificar las fases ya existentes en el programa.
- 
Borrar programa: Borrado de los programas almacenados en la biblioteca.
- 
Importar/exportar programa: Permite importar/exportar programas desde una memoria USB externa.



- 
Importar programa: Permite importar nuevos programas desde una memoria USB externa. Al acceder al USB, se mostrarán sólo los ficheros con extensión “.prg” además de las carpetas.



- 
Marcador: Indica el número de programas seleccionados.
- 
Seleccionar/deseleccionar todo: Selecciona o deselecciona todos los programas de la carpeta en la que se encuentre.
- 
Atrás: Permite salir de la carpeta en la que se encuentra.
 En caso de importar un programa con el mismo nombre que uno existente, se preguntará si se desea reemplazar el programa en cuestión o cancelar la operación. Como pueden ser muchos programas los que se encuentren en esta tesitura, habrá una casilla para “hacer lo mismo en todos los casos”.
- 
Exportar programa: Exportar programas existentes en la biblioteca a una memoria USB externa.



Se podrán seleccionar los programas que quieren ser exportados.

- 
Seleccionar/deseleccionar favoritos: Permite seleccionar todos los programas o los programas que están dentro de favoritos, indicando en todo momento la cantidad de programas seleccionados.

El conjunto de programas seleccionado será guardado en una carpeta “PROGRAMS” en el directorio raíz del USB y cada programa será un fichero.

4.1.3 Biblioteca de fases

Desde la biblioteca de fases se podrá modificar el nombre de cada fase. Una vez incluido en un programa, a la hora de visualizar la información de fases, el nombre que se mostrará para la fase será otro. Será un nombre dinámico compuesto por el tipo de fase y un parámetro (T°, rpm)

La librería de fases será editable, pudiendo, crear, modificar, copiar o borrar las fases existentes (Ver apartado 3.1).



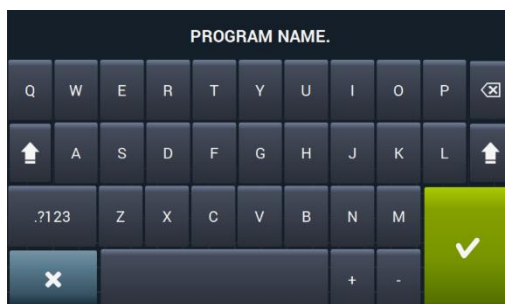

-  **Crear fase:** Creación de nuevas fases de lavado. Al pulsar este botón, lo primero que nos pedirá es introducir el nombre del nuevo programa.

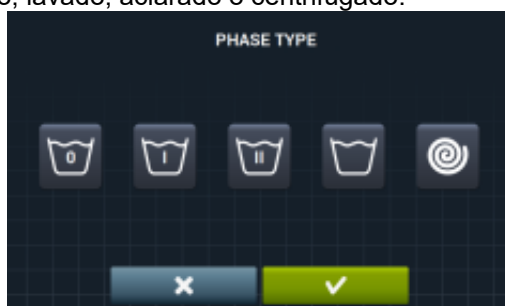

Seguidamente nos mostrará la siguiente pantalla para poder seleccionar el tipo de fase que se quiere crear, remojo, prelavado, lavado, aclarado o centrifugado.







-  **Copiar fase:** Copia de una fase existente en la biblioteca, asignándole un nombre nuevo.
-  **Borrar fase:** Borrado de las fases almacenados en la biblioteca.
-  **Modificar fase:** Modificación de los parámetros de la fase seleccionada.

4.2 Configurar Sistema

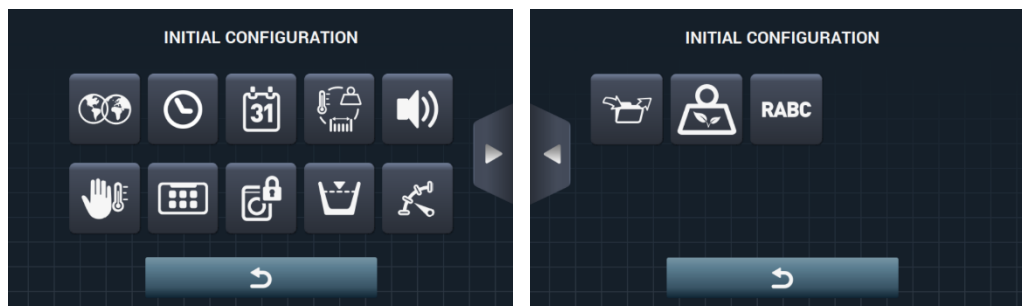
Acceso: [Pantalla principal]  ⇒ [Menu Principal] 

En la configuración del sistema se podrán configurar los siguientes apartados:



-  **Pantalla siguiente.**
-  **Pantalla anterior.**
-  **Idioma:** Los textos de la lavadora podrán ser visualizados en 34 idiomas diferentes, la edición de textos sólo podrá hacerse mediante caracteres occidentales.

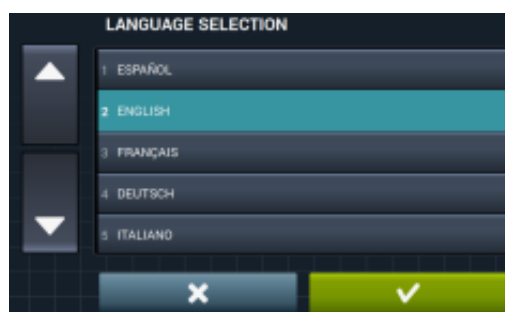

-  **Hora:** Configuración de la hora del momento. Se podrá seleccionar el formato de visualización (12 horas / 24 horas (por defecto))

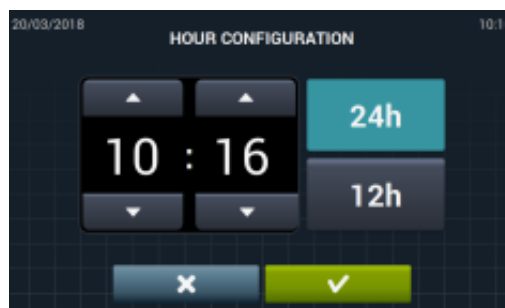

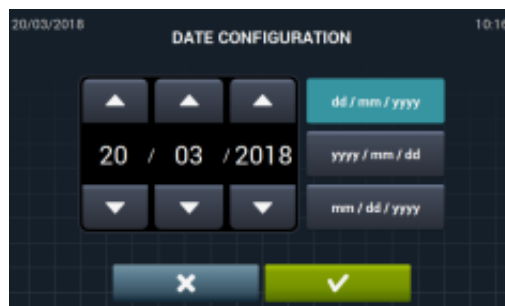

-  **Fecha:** Configuración de la fecha del momento. Se podrá seleccionar el formato de visualización (dd/mm/yyyy (por defecto) / yyyy/mm/dd / mm/dd/yyyy).







- 
Unidades de medida: Permite seleccionar la unidad de la medida en el que se quieren visualizar la temperatura (°C (por defecto) ó °F), el peso (Kg (por defecto) ó Lb) y el tamaño (mm (por defecto) ó in).





- 
Parada térmica: Configuración general de la parada térmica. Si esta deshabilitado, no se realizará la parada térmica aunque la fase en ejecución tenga activo dicho parámetro. Si esta habilitado en cambio, se respetará la configuración de cada fase y se actuará en consecuencia. Por defecto, activo. En las máquinas sin calentamiento (HW) siempre estará desactivado.



- 
Ahorro de agua en pesado: Se puede configurar el ahorro de agua deseado para el pesado, pudiendo elegir entre 3 opciones diferentes de pesado y 3 niveles de ahorro. Dependiendo de la carga, habrá una reducción u otra en el nivel de agua y dosificación de detergente.

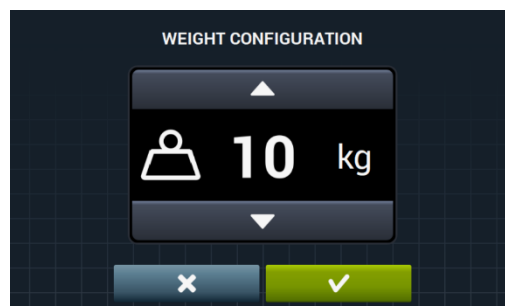

- 
 Opción de pesado desactivado.
- 
 Opción de pesado automático, estará disponible en base a la configuración de kits existentes.
- 
 Opción de pesado manual, se introducirá el peso de la ropa de forma manual, pulsando en el icono del peso de la pantalla principal (Ver apartado 2.2, punto 3).
- 
 Opción de pesado inteligente, esta opción hace una estimación de carga al inicio de cualquier programa. El mensaje "LOAD DETECTION" aparecerá mientras se ejecuta. Esta opción puede durar varios minutos. El tiempo empleado no está incluido en la duración del programa.





- 
 Opción de ahorro desactivado.
- 
 Opción de ahorro bajo.

-  Opción de ahorro medio.
-  Opción de ahorro alto.
-  **Niveles:** Posibilita la configuración en mm. de los 5 niveles configurables. Cada tipo de nivel tendrá un valor por defecto y un rango de configuración, valores que dependerán del modelo seleccionado. (Ver tabla de niveles por modelo).

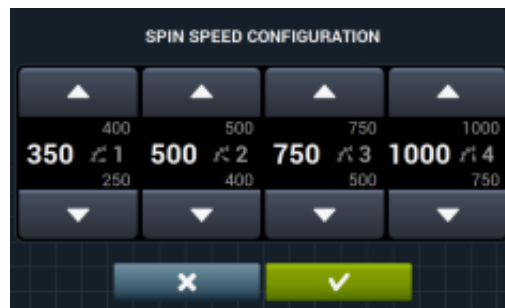
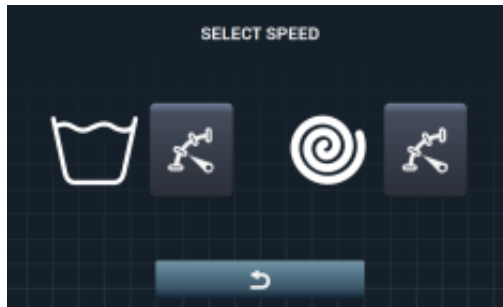

-  **Velocidad:** Posibilita la configuración en RPM de los diferentes tipos de velocidad existentes, tanto en lavado como en centrifugado. Cada tipo de velocidad tendrá un valor mínimo y máximo de configuración.



- 
Importar/Exportar Configuración: Posibilitar importar desde una memoria USB una configuración de máquina o exportar a una memoria USB la configuración actual de la máquina. Al pulsar este botón, se nos mostrará una pantalla intermedia para seleccionar si queremos importar o exportar.

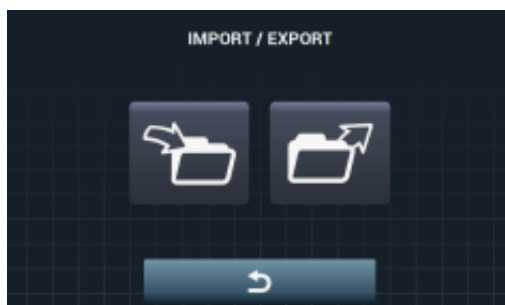

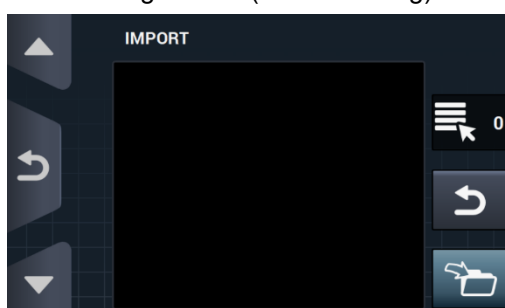

Si seleccionamos IMPORTAR, se nos mostrará pantalla para poder navegar por el USB, solamente se podrán seleccionar ficheros de configuración (extensión .cfg).



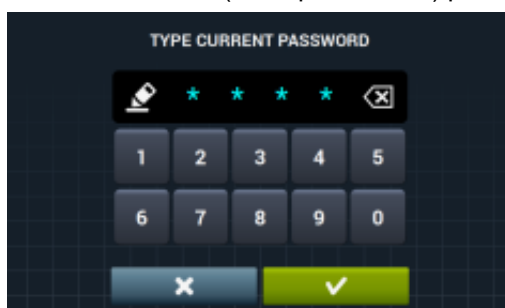

Si seleccionamos EXPORTAR, guardará la configuración actual de la máquina en el directorio raíz del USB en la carpeta "CONFIGS". Cada fichero de configuración se llamará de la forma: CONFIG_Modelo_Fecha_hora.cfg.

- 
Acceso restringido: Permite restringir la configuración de la lavadora, estableciendo una contraseña para entrar en el menú principal. Por defecto, desactivado. Se podrá configurar la contraseña deseada (1234 por defecto) para entrar en el menú principal.



- 
HUD: La configuración HUD activa/desactiva la visualización de los parámetros en las diferentes pantallas (ver apartado 4.2.1).



-  **Beep:** Opción que permite deshabilitar el zumbador. Por defecto, habilitado.
-  **RABC/Trazabilidad:** Se registrará la información de cada lavado, guardando la información siguiente:
 Al comienzo de cada ciclo: Programa, hora inicio, peso (si hay)
 Durante la ejecución, cada 15 segundos: Nivel, temperatura y error (si hay)
 A la hora de descargar los datos habrá que seleccionar el periodo deseado (por defecto, fecha inicio y fecha fin, el día en que se está).
 Los datos se mantendrán guardados durante 15 días mínimamente.
 Cada vez que haya una descarga, se creará una "RABC" en el directorio raíz del USB. Cada fichero rabc se llamarán de la forma: RABC_Modelo_Fecha_hora.rabc.

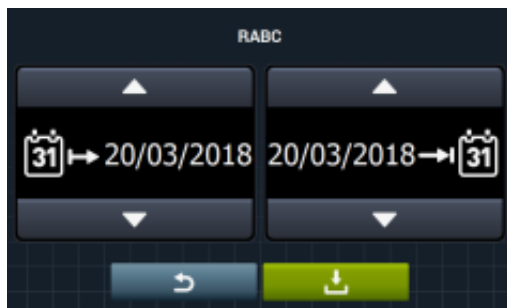

4.2.1 Configuración HUD

Configuración de los parámetros que se quieren visualizar en la *pantalla OFF*, *pantalla principal* y *pantalla de ejecución*, además de la configuración del apagado automático y el ahorro de energía.

Acceso: [Pantalla principal]  ⇒ [Menú Principal]  ⇒ [Configurar sistema] 



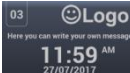

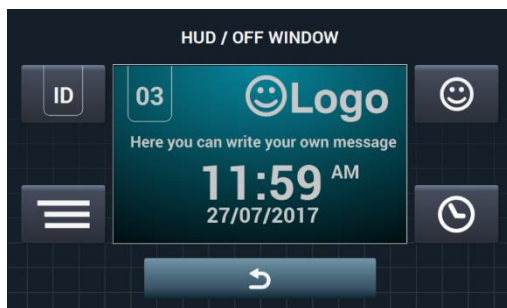
-  **Pantalla OFF:** Estos son los parámetros que podrán ser configurados:



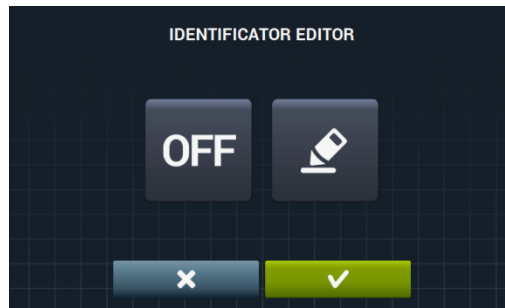

-  **Identificador de máquina:** Se podrá habilitar/deshabilitar la identificación de máquina, además de poder editar el número que se le quiere asignar (Entre 1 y 99). Por defecto, deshabilitado. Este identificador será obligatorio en caso de usar comunicación remota.



Se habilita el identificador de la máquina pulsando en el botón “OFF”  y después en el botón de edición .



-  **Fecha:** Opción que se puede habilitar/deshabilitar. Por defecto, habilitado.
-  **Logo:** Permite seleccionar si se quiere mostrar el logo. Por defecto, habilitado.

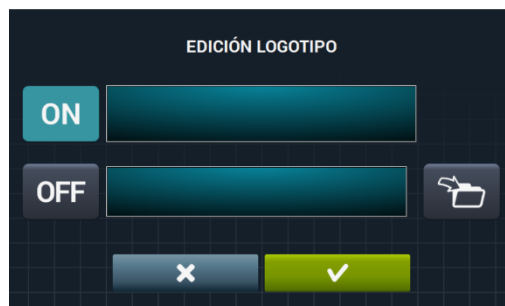

Pulsando en el botón importar , se puede importar un logotipo a la máquina desde una memoria USB externa, el archivo del logotipo tiene que ser en formato .png y con una resolución de 290 x 80 pixeles.

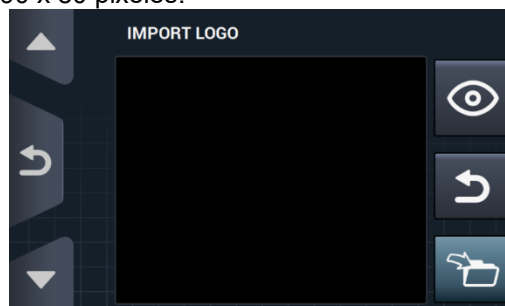



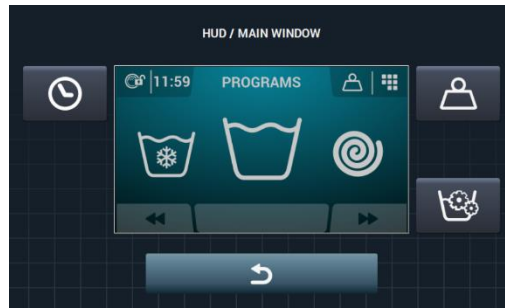

El botón previsualizar , nos permite comprobar que el logotipo se ve correctamente.

-  **Mensaje lavandería:** Mensaje de inicio que podrá ser editado por el usuario (Max. 40 caracteres). Por defecto, deshabilitado.







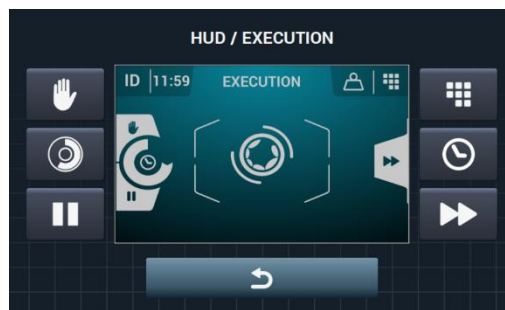

- 
Pantalla principal: A continuación se muestran los parámetros configurables:



- 
Hora: Opción que permite mostrar/ocultar la hora. Por defecto, habilitado.
- 
Peso ropa: En caso de deshabilitar esta opción, no se mostrará el icono de peso. Por defecto, deshabilitado.
- 
Programación instantánea: Si la programación instantánea está deshabilitada, permitirá visualizar los parámetros de cada fase pero no podrán ser editados. Por defecto, habilitado.

- 
Pantalla de ejecución: Estas son las opciones que permite la pantalla de ejecución:



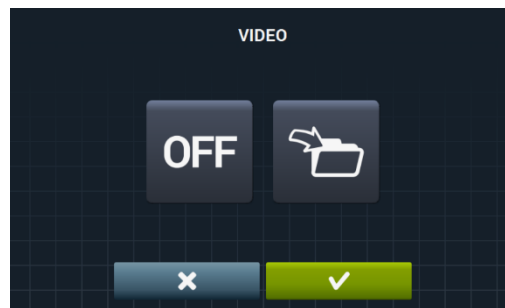

- 
Hora: Opción que permite mostrar/ocultar la hora. Por defecto, habilitado.
- 
Tiempo restante: Opción para mostrar/ocultar el tiempo restante total y el indicador de progreso del programa en la pantalla de ejecución. Por defecto, habilitado.
- 
Botón de parada, STOP: Permite ocultar el botón de parada. Por defecto, habilitado.
- 
Botón de PAUSE: Permite ocultar el botón de pause. Por defecto, habilitado.
- 
Botón de menú: Opción que permite mostrar/ocultar el icono del menú de ejecución, Por defecto, habilitado.
- 
Botón de Avance: Permite ocultar el botón de avance y la información que hace referencia a la fase siguiente. Por defecto, habilitado.
- 
Apagado automático: Si esta opción se encuentra activa y se encuentra en la pantalla principal, se pasará a la *Pantalla Off* después de 30 minutos sin actividad alguna. Por defecto, habilitado.
- 
Ahorro energía: Opción que permite ahorrar energía apagando el backlight de la pantalla después 10 minutos de haber apagado la lavadora. Si se toca en cualquier parte de la pantalla el backlight será encendido de nuevo y se irá a la *Pantalla principal*. Por defecto, habilitado.

-  **Importar video:** Permite reproducir un video en la pantalla de la máquina después de 10 minutos de inactividad. Si se activa el “Ahorro de energía” automáticamente se desactiva la reproducción del video.

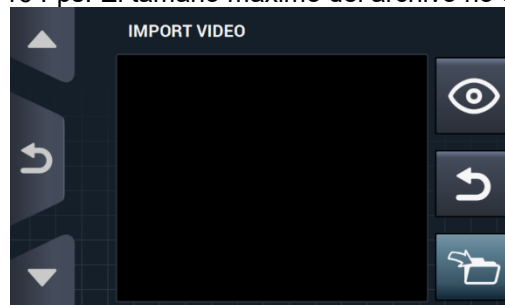

Pulsando en el botón importar , se puede importar un video a la máquina desde una memoria USB externa, solamente se podrán importar archivos de video (avi, mov,...), y solo se podrá tener un archivo de video instalado en la máquina. La resolución recomendada de los videos será, para las máquinas con pantalla de 4,3" de 480x272 pixeles, y para las máquinas con pantalla de 7" de 800x480 pixeles. No se aconseja que supere los 16 Fps. El tamaño máximo del archivo no debe superar los 25Mb.



El botón previsualizar , nos permite comprobar la correcta reproducción del archivo de video.

5 MANTENIMIENTO

5.1 Irregularidades eléctricas y mecánicas

Antes de llamar al Servicio de Asistencia Técnica, compruebe:

- Que llega corriente a la máquina.
- El estado de los fusibles.
- Que la tensión coincide con la de la máquina.

Si la lavadora no coge el nivel de agua, compruebe:

- Que la llave de paso del agua está abierta.
- Que el filtro de entrada de agua no está obstruido.
- Que la presión del agua de red está entre 2/4 Kg/cm² (28/56 psi).

Si la lavadora vibra excesivamente, compruebe que ninguno de los tornillos de los paneles está suelto.

Si hay un corte de tensión: Se desagua la cuba y la puerta queda bloqueada. Si quiere sacar la ropa de la lavadora puede desbloquear la puerta tirando hacia abajo de la cinta situada detrás del panel frontal.

5.2 Avisos

Todos los avisos y errores se advierten en pantalla acompañados por un aviso acústico. En caso de error, se mantiene la información de fase y estado para saber exactamente donde se ha producido el error.

Estos son los avisos que pueden aparecer en una lavadora:

DESCRIPCIÓN	CAUSA Y ACCIÓN
PUERTA ABIERTA	Si tenemos la puerta abierta al comienzo de un programa, mostrará en pantalla el mensaje "PUERTA ABIERTA" y pitará durante 30 segundos no pitando más posteriormente. Sólo se dará la opción de "OK". El programa no comenzará y el usuario podrá volver a intentarlo.
AGUA EN CUBA	Al finalizar un programa si no tenemos un nivel de agua de 0mm, mostrará en pantalla el mensaje "AGUA EN CUBA". Se mostrarán las 2 opciones "continuar" o "finalizar". Si pulsamos "continuar" volverá a comprobar si el nivel es 0mm. Si es así desbloqueará la puerta, si no volverá a dar error. Si pulsamos "finalizar" terminará el programa y desbloqueará la puerta.
NO HAY COMUNICACIÓN ENTRE TARJETAS	Dentro del menú SAT en el apartado de Kits extra, al ir a activar un kit, si no se detecta comunicación entre la tarjeta de control principal y la tarjeta auxiliar se dará este aviso. Se podrán desactivar kits activos sin comunicación entre tarjetas, pero no se podrán activar.
TANQUES LLENOS (T1/T2/T3)	Dará este aviso cuando el tanque Tx esté activo en una fase de desague y detecta que la entrada "Nivel max. Tanque x" se ha activado. No seguirá desaguando a Tx y cambiará a desagüe normal D1. Pitido activo durante 10 segundos. El aviso desaparecerá al pulsar OK o al pasar el tiempo.
TANQUES VACIOS (T1/T2/T3)	Dará este aviso cuando el tanque Tx esté activo en una fase de llenado y detecta que la entrada "Nivel min. Tanque x" se ha activado. No seguirá llenando desde Tx y cambiará a llenar desde el agua fría normal. Pitido activo durante 10 segundos. El aviso desaparecerá al pulsar OK o al pasar el tiempo.
NO HAY COMUNICACIÓN CON KIT DE PESAJE	Dará este aviso si al ir a activar el kit de pesaje o realizar una calibración, la tarjeta auxiliar está conectada y funcionando correctamente, pero no se puede comunicar con el aparato de pesaje. No se podrá activar el kit ni realizar la calibración.

<p>CALIBRACIÓN DE PESAJE – ASEGURAR MÁQUINA VACÍA</p>	<p>Dará este aviso al lanzar una calibración del kit de pesaje, con el objetivo de informar al usuario de que la lavadora tiene que estar vacía, sin peso encima, etc... antes de lanzar una calibración. Ninguna. Aviso meramente informativo. Botón de “OK” para ocultar el aviso y lanzar realmente la calibración.</p>
<p>CALIBRACIÓN DE PESAJE – PROCESO EN MARCHA</p>	<p>Dará este aviso mientras se está ejecutando la calibración del sistema de pesaje. Ninguna. Aviso meramente informativo. No tendrá ningún botón y se mostrará durante 5 segundos mientras se ejecuta la calibración.</p>
<p>CALIBRACIÓN DE PESAJE – CALIBRACIÓN ERRONEA</p>	<p>Dará este aviso cuando al terminar el proceso de calibración, no se haya podido poner a cero correctamente el sistema de pesaje. Ninguna. Aviso meramente informativo. Botón de “OK” para ocultar el aviso.</p>
<p>CALIBRACIÓN DE PESAJE– NECESIDAD DE CALIBRACIÓN</p>	<p>Dará este aviso cuando al pulsar “Start” para ejecutar un programa de lavado midamos un peso menor que -3 Kg o mayor que 10Kg que el nominal. Se mostrarán las 2 opciones "Cancel" o "Ok". Si pulsamos “Ok” continuará con el programa con el peso nominal. Si pulsamos “cancel”, abortará el programa.</p>
<p>EASY LOAD – LANZAR PROCESO</p>	<p>Dará este aviso al pulsar el botón de Easy Load en la pantalla principal. Se informará al usuario de que introduzca ropa la ropa y cierre la puerta y se le preguntará si quiere lanzar el ciclo de Easy Load. Se mostrarán las 2 opciones "Cancel" o "Ok". Si pulsamos “Cancel” abortará el ciclo de Easy Load y volverá a la pantalla de selección. Si pulsamos “OK” lanzará el ciclo de Easy Load.</p>
<p>EASY LOAD – CICLO EN EJECUCIÓN</p>	<p>Dará este aviso mientras se esté ejecutando el ciclo de Easy Load, informando al usuario de que este está en marcha. No dispone de ningún botón. Mensaje meramente informativo, el usuario no podrá hacer nada más que esperar a que finalice el ciclo.</p>
<p>LOAD DETECTION</p>	<p>Dará este aviso al principio del programa de lavado, cuando la opción “pesado inteligente” esté activada. No dispone de ningún botón. Mensaje meramente informativo. Esta operación puede durar varios minutos.</p>

Estos son los errores que pueden aparecer en una lavadora:

ERROR	DESCRIPCIÓN	CAUSA Y ACCIÓN
E1	CORTE SUMINISTRO ELÉCTRICO DETECTADO	Se mostrará este error al recuperar la tensión después de registrarse un corte del mismo en la ejecución de un programa, la máquina retomará el programa donde lo dejó automáticamente, mostrando un mensaje de advertencia durante 30 seg. Se mostrarán las opciones "continuar" o "finalizar". Si se pulsa continuar, continuará desde la fase en que se fue la tensión, pero comenzando desde el principio de la fase. Si se pulsa "finalizar" en cambio, finalizará el programa, desbloqueando la puerta.
E2	FALLO EN BLOQUEO	Se mostrará este error al iniciar un programa y no se consigue bloquear la puerta o al desbloquearse durante la ejecución de un programa. El programa finalizará y podrá volver a intentarlo, asegúrese de que la puerta está correctamente cerrada. Si el error persiste, contacte con su servicio técnico.
E3	FALLO EN DESAGÜE / AGUA EN LA CUBA	Se mostrará este error cuando la lavadora no es capaz de vaciar el agua del tambor, se mostrarán las 2 opciones "continuar" o "finalizar". Asegúrese de que la salida del desagüe no está obstruida. Si la máquina está equipada con bomba de desagüe limpie el filtro.
E4	NIVEL MÁXIMO DE AGUA ALCANZADO	Se mostrará este error cuando la lavadora detecta un nivel de agua excesivo. Verifique estando la lavadora en reposo no entra agua. Si es así llame al servicio técnico.
E5	FALLO ENTRADA AGUA	Se mostrará este error cuando la lavadora detecta que no está entrando agua. Antes de llamar al servicio técnico: Asegúrese de que la llave de paso esté abierta. Compruebe que la configuración de desagüe es correcta (válvula / bomba).
E6	FALLO CALENTAMIENTO	Se mostrará este error cuando la lavadora no consigue calentar el agua correctamente. Antes de llamar al servicio técnico compruebe que la configuración de calentamiento es la correcta.
E7	TEMPERATURA MÁXIMA SUPERADA	Se mostrará este error cuando detecta una temperatura excesiva. Sólo se mostrará la opción "finalizar". Al pulsar, finalizará el programa, si la temperatura es inferior a 50°. Si no es así, dará el error E11: ROPA CALIENTE
E8	ERROR DE MOVIMIENTO	Se mostrará este error cuando la lavadora no detecta movimiento. Mostrará el aviso "El programa finalizará" y transcurridos 2 minutos, el botón de OK aparecerá y pulsándolo se terminará el programa.

E9	DESEQUILIBRIO	Se mostrará este error cuando la lavadora no es capaz de equilibrar la ropa. Intente cargar la ropa de una manera más homogénea.
E10	DESEQUILIBRIO MAX	Se mostrará este error cuando la lavadora detecta un movimiento excesivo durante el centrifugado. Si este error aparece repetidamente, llame al servicio técnico, podría haber un problema de instalación y/o amortiguación.
E11	ROPA CALIENTE	Se mostrará este error cuando al terminar un programa la temperatura dentro de la cuba supera los 50°C (122°F). Espere hasta que la temperatura descienda de los 50°C (122°F), y el programa finalizará automáticamente.
E12	ERROR DESBLOQUEO	Se mostrará este error cuando la lavadora no consigue desbloquear la puerta al finalizar un programa. Lo dará después de haber hecho 3 intentos de desbloqueo cada 20 segundos. Sólo se dará la opción de "finalizar". Al pulsar esta opción, volverá intentarlo y si no lo consigue seguirá dando error. No fuerce la puerta y llame al servicio técnico, ellos le asesorarán para abrir la puerta de una forma segura.
E23	ERROR EN PESAJE	Se mostrará este error cuando la lavadora detecta un error de comunicación con el dispositivo de pesaje. Llame al servicio técnico. Se mostrarán las dos opciones, "OK" y "Cancel". Pulsando "Cancel" se abortará la ejecución del programa volviendo a selección. Pulsando "OK" se continuará con la ejecución del programa con el valor de peso nominal de la máquina.
E25	ERROR DE COMUNICACIÓN CONTROL-CONTROL AUX	Se mostrará este error cuando la lavadora detecta un error de comunicación con la tarjeta auxiliar utilizada en diversos accesorios. Llame al servicio técnico. Se mostrarán las dos opciones, "OK" y "Cancel". Pulsando "Cancel" se abortará la ejecución del programa volviendo a selección. Pulsando "OK" se continuará con la ejecución del programa ignorando la función del accesorio correspondiente.
E26	ERROR DE TÉRMICO MOTOR	Se mostrará este error cuando la lavadora detecta una temperatura excesiva en el motor. Llame al servicio técnico.
E27	ERROR NTC FUERA DE RANGO	Se mostrará este error cuando la lavadora detecta una temperatura fuera de rango. El sensor de temperatura estará desconectado o dañado. Llame al servicio técnico. Se mostrarán 2 opciones "OK" o "Cancel". Pulsando "OK", continuará con el programa ignorando el calentamiento y pulsando "Cancel", finalizará el programa.
E28	ERROR SENSOR DE PRESIÓN FUERA DE RANGO	Se mostrará este error cuando la lavadora detecta un nivel de agua fuera de rango. El sensor de presión estará desconectado o dañado. Llame al servicio técnico. Este error no tendrá ningún botón disponible y solamente se podrá abortar apagando la máquina.

AUTOSERVICIO V2.0

6	INTRODUCCIÓN	35
7	INTERFACE	35
7.1	Pantalla de Selección 1 - Botones.....	35
7.2	Pantalla de selección 2 - Pago.....	36
7.3	Pulsos de moneda y “Credit mode”	36
7.4	Pantalla ejecución.....	37
8	PROGRAMAS	38
8.1	Biblioteca de programas	38
9	CONFIGURACION	39
9.1	Gestión de programas	39
9.2	Configurar Sistema	39
9.2.1	Configuración Avanzada.....	39
9.2.2	Programación HUD.....	45
9.2.3	Tabla de divisas	47
10	MANTENIMIENTO	49
10.1	Errores	49

6 INTRODUCCIÓN

En este apartado se indican las características exclusivas para las lavadoras de Autoservicio. Es obligatorio leer las advertencias de seguridad, y es necesario leer el resto del manual para la total comprensión del funcionamiento.

7 INTERFACE

7.1 Pantalla de Selección 1 - Botones

Cuando se alimenta la máquina irá a *Pantalla selección 1*. En esta pantalla tendremos 4 botones grandes fijos para poder seleccionar programas de lavado.

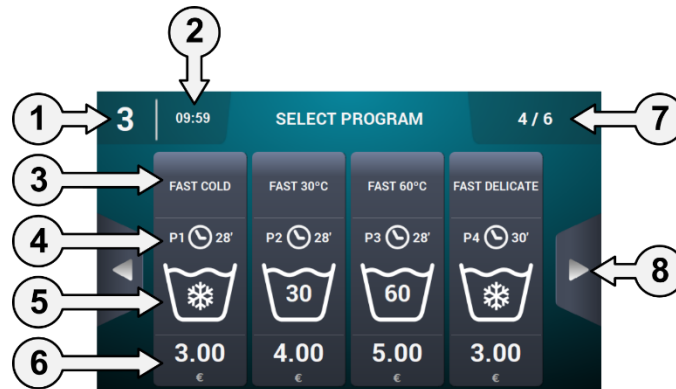

1. **Identificador de máquina:** Se muestra la etiqueta que identifica al aparato en base a la configuración existente (si está habilitado).
2. **Hora:** Se muestra la hora del momento en el formato seleccionado por el usuario.
3. **Nombre de programa:** Nombre configurado para el programa seleccionado.
4. **Duración de programa:** Duración, en minutos, estimada para el programa seleccionado.
5. **Temperatura programa:** Temperatura máxima entre las diferentes fases que contiene el programa.
6. **Precio:** Solamente en modo Coin, en CP y CR no se mostrará en precio y se mostrará un led en su lugar.
7. **Número de programas:** Se muestra el número de los programas visualizados y el número de programas disponibles. En la pantalla se muestra un máximo de 4 programas, y el número máximo de programas a mostrar será de 16 (4 pantallas de 4 botones).
8. **Flechas laterales de navegación:** En el caso de tener más de 4 programas en favoritos, se muestran las flechas de navegación laterales, que permiten mostrar la siguiente pantalla de selección.

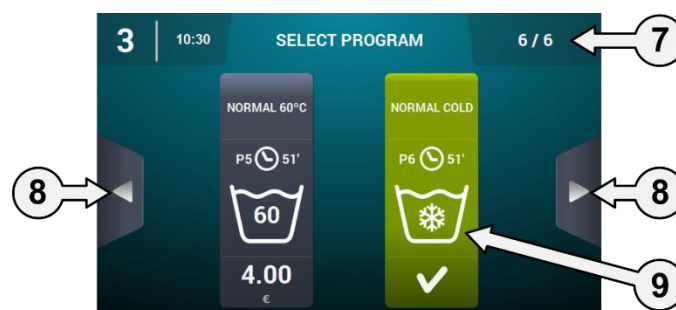

9. **Botón activo:** En esta primera pantalla se podrá hacer el pago. Al llegar al importe de un programa, el precio desaparecerá y se cambiará el color del botón, indicando que el programa está habilitado para ser ejecutado.

Al pulsar en un botón de programa se pasará a la *“Pantalla de Selección 2 – Pago”*.

Al finalizar la ejecución de un programa, volverá a esta pantalla.

Asimismo, aunque se haya tocado en la pantalla o se haya empezado a introducir dinero, si no hay actividad en 15 minutos, volverá a esta pantalla, reseteando el importe que se haya podido introducir.

7.2 Pantalla de selección 2 - Pago

En esta pantalla tendremos la misma información que en la pantalla anterior, pero solamente del programa seleccionado, acompañado de animación y texto de ayuda. Además tendremos dos botones de navegación para poder cambiar de programa.

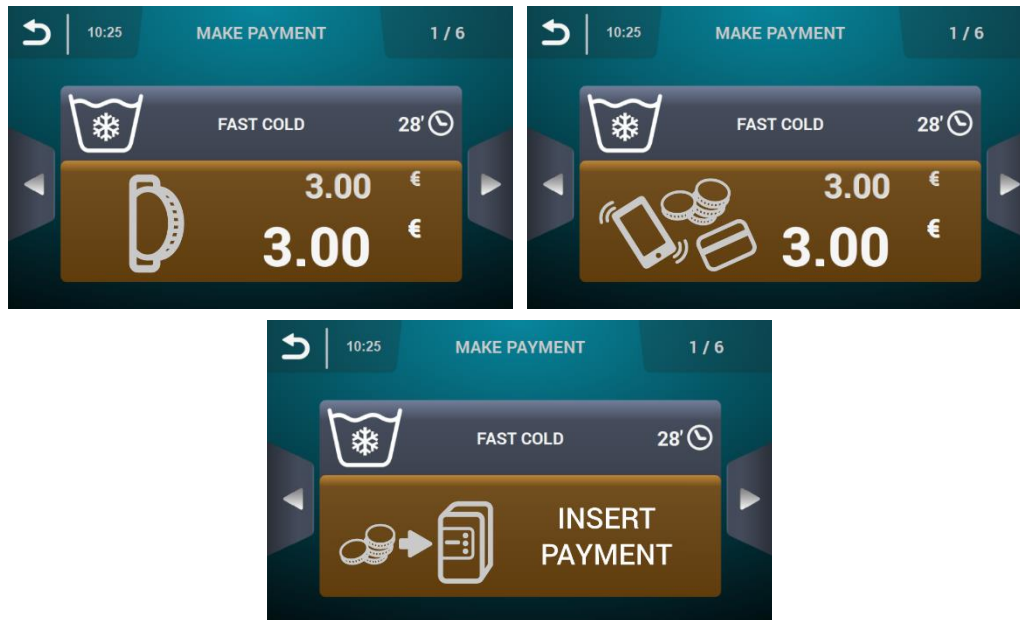

El botón se mostrará en marrón mientras no se introduzca el importe indicado en el programa.

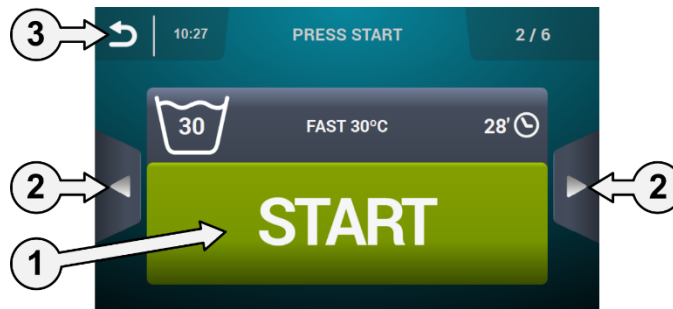

1. **Botón Start:** Al llegar al importe del programa, aparecerá el botón grande de "Start" en verde.
2. **Botones de navegación:** Nos permite cambiar de programa.
3. **Botón atrás:** Pulsando este botón, volvemos a la pantalla principal "Selección 1 – Botones".

Si después de 15 minutos no ha habido actividad alguna se reseteará el importe introducido, perdiendo el dinero y volverá a la pantalla "Selección 1 – Botones".

Al pulsar el botón de "Start" comenzaremos a ejecutar el programa seleccionado.

7.3 Pulsos de moneda y "Credit mode"

Para poder ejecutar cualquier programa habrá que hacer el pago correspondiente primero. Para ello, dependiendo de la configuración de autoservicio existente, controla la introducción de monedas (modo COIN) o recibe la señal correspondiente en modo CP ó Multipago, a través de la entrada "micro monedero" para permitir la ejecución del programa seleccionado.

Estando en modo autoservicio (tanto en la pantalla 1, como en la 2 de selección, como ejecutando un programa de autoservicio), existirá la posibilidad de entrar en "Credit mode". Si se activa la entrada "encimera abierta" en los modelos industriales o se acciona la llave del monedero o CP de los modelos profesionales, se pedirá el password para entrar en "Credit mode".

Si se entra en "Credit mode", se sale automáticamente del modo autoservicio y se comporta como si estuviera en modo normal, mostrando la información definida en la *Pantalla principal OPL* y dando la posibilidad de realizar todas las acciones definidas en dicha pantalla.

Al entrar en el menú principal, se visualizan todas las opciones disponibles para las lavadoras de autoservicio.

Si se desactiva la entrada “encimera abierta” en los modelos industriales o se retira la llave del monedero o CP de los modelos profesionales, se sale de “Credit mode” automáticamente. Si estamos en una pantalla secundaria del menú principal (configuración, mantenimiento...) y se sale de “Credit Mode”, actuará como si estuviese en este modo hasta salir a la *Pantalla principal* (guardando los cambios). Una vez en la *Pantalla principal*, sale de credit mode.

7.4 Pantalla ejecución

Al pulsar el botón START, comienza el programa y se muestra la *Pantalla de ejecución*.

Estando en ejecución también existirá la posibilidad de entrar en “Credit mode” de la misma forma que se ha explicado anteriormente. Si se entra en este modo, se sale automáticamente del modo autoservicio y se comporta como si estuviera en modo OPL, mostrando la información definida en la *Pantalla ejecución OPL* y dando la posibilidad de realizar todas las acciones definidas en dicha pantalla.

En modo autoservicio no existe la opción de avanzar de fase o pausar el programa a no ser que se entre en modo “Credit mode”.

Tampoco estará por defecto el botón STOP para permitir abortar un programa, aunque sí que podrá ser activado mediante el HUD.

En caso de activar el botón STOP, existe un periodo de gracia en el cual se puede abortar un programa sin perder el crédito introducido. Si se aborta una segunda vez dentro del periodo de gracia, se perderá el crédito.

Una vez pasado el periodo de gracia, se necesitará realizar una pulsación larga de 3 segundos para abortar el programa y se perderá el crédito.

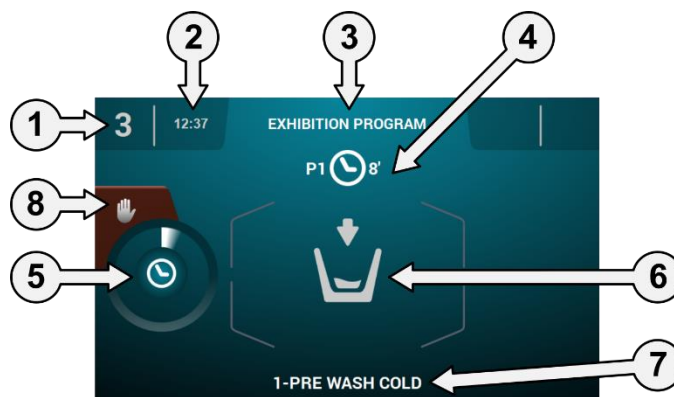

1. **Identificador de máquina:** Etiqueta que identifica la máquina.
2. **Hora:** Horas y minutos en el formato seleccionado.
3. **Nombre de programa:** Nombre configurado para el programa seleccionado.
4. **Número y duración de programa:** Posición del programa en la lista de programas (Mis Programas), y la duración, en minutos, estimada para el programa seleccionado.
5. **Indicador de progreso de programa:** Estado del progreso del programa, relación entre el tiempo total y el tiempo restante del programa.
6. **Estado (dibujo):** Dibujo animado que muestra lo que está realizando la lavadora (llenando, vaciando, lavando, aclarando, centrifugando o desapelmazando).
7. **Fase en ejecución:** Identificador y nombre de la fase en ejecución
8. **Stop:** (deshabilitado por defecto): Botón para abortar el programa. Se pedirá mensaje de confirmación.

8 PROGRAMAS

Existirá una biblioteca de programas compuesto por todos los programas que llevarán por defecto, así como los programas creados por el propio usuario.

8.1 Biblioteca de programas

Estos son los programas que irán por defecto en la biblioteca de programas:

- P1: Rápido frío
- P2: Rápido 30°C (86°F)
- P3: Rápido 60°C (140°F)
- P4: Rápido delicado

P1					
	8	2	2	2	6
	1	3	3	3	
	3	3	3	3	4
	0	0	0	0	
	15;05	15;05	15;05	15;05	
	✓	✓	✓	✓	
	✓	✓	✓	✓	
	✓	✓	✓	✓	
					✓
					✓
D	D2, D3			D4, D5	

P2					
	8	2	2	2	6
	30				
	1	3	3	3	
	3	3	3	3	4
	1	0	0	0	
	15;05	15;05	15;05	15;05	
	✓	✓	✓	✓	
	✓	✓	✓	✓	
	✓	✓	✓	✓	
					✓
					✓
D	D2, D3			D4, D5	

P3					
	8	2	2	2	6
	60				
	1	3	3	3	
	3	3	3	3	4
	1	0	0	0	
	15;05	15;05	15;05	15;05	
	✓	✓	✓	✓	
	✓	✓	✓	✓	
	✓	✓	✓	✓	
					✓
					✓
D	D2, D3			D4, D5	

P4					
	8	2	2	2	6
	2	4	4	4	
	2	2	2	2	3
	0	0	0	0	
	08;06	08;06	08;06	08;06	
	✓	✓	✓	✓	
	✓	✓	✓	✓	
	✓	✓	✓	✓	
					✓
					✓
D	D2, D3			D4, D5	

9 CONFIGURACION

9.1 Gestión de programas

En caso de que la lavadora esté configurada en modo autoservicio, solamente estarán disponibles los 16 primeros programas, pasando a estar disponibles el resto al entrar en "Credit Mode".







9.2 Configurar Sistema

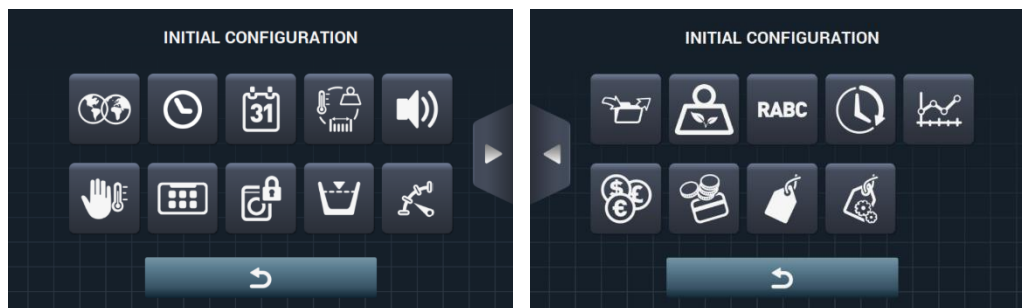





9.2.1 Configuración Avanzada

Acceso: [Pantalla principal]  ⇒ [Menú Principal] 

En la configuración del sistema se podrán configurar los siguientes apartados, igual que en "Credit mode" (Ver apartado 4.2):



- ▶ **Pantalla siguiente.**
- ◀ **Pantalla anterior.**
-  **Idioma:** Los textos de la lavadora podrán ser visualizados en 34 idiomas diferentes, aunque la edición de textos sólo podrá hacerse mediante caracteres occidentales.
-  **Hora:** Configuración de la hora del momento. Se podrá seleccionar el formato de visualización (12 horas / 24 horas (por defecto)).
-  **Fecha:** Configuración de la fecha del momento. Se podrá seleccionar el formato de visualización (dd/mm/yyyy (por defecto) / yyyy/mm/dd / mm/dd/yyyy).
-  **Unidades de medida:** Permite seleccionar la unidad de la medida en el que se quieren visualizar la temperatura (°C (por defecto) ó °F), el peso (Kg (por defecto) ó Lb) y el tamaño (mm (por defecto) ó in).
-  **Parada térmica:** Configuración general de la parada térmica. Si esta deshabilitado, no se realizará la parada térmica, aunque la fase en ejecución tenga activo dicho parámetro. Si está habilitado en cambio, se respetará la configuración de cada fase y se actuará en consecuencia. Por defecto, activo.
-  **Ahorro de agua en pesado:** Se puede configurar el ahorro de agua deseado para el pesado, pudiendo elegir entre 3 opciones diferentes de pesado y 3 niveles de ahorro. Dependiendo de la carga, habrá una reducción u otra en el nivel de agua y dosificación de detergente.
-  **Niveles:** Posibilita la configuración en mm. de los 5 niveles configurables. Cada tipo de nivel tendrá un valor por defecto y un rango de configuración, valores que dependerán del modelo seleccionado. (Ver tabla de niveles por modelo).

-  **Velocidad:** Posibilita la configuración en RPM de los diferentes tipos de velocidad existentes, tanto en lavado como en centrifugado. Cada tipo de velocidad tendrá un valor mínimo y máximo de configuración. (Ver tabla de equivalencias RPM/V por modelo).
-  **Importar/Exportar Configuración:** Posibilitar importar desde una memoria USB una configuración de máquina o exportar a una memoria USB la configuración actual de la máquina. Al pulsar este botón, se nos mostrará una pantalla intermedia para seleccionar si queremos importar o exportar (como en programas).
-  **Credit Mode:** Si la lavadora está en modo autoservicio, se podrá configurar la contraseña para Credit Mode (1234 por defecto). Anote la contraseña y guárdela, si lo pierde póngase en contacto con el servicio de asistencia técnica.
-  **HUD:** En modo autoservicio también podrán ser configurados la *Pantalla principal* (la primera y segunda pantalla de selección) y la *Pantalla de ejecución*. (Ver apartado 9.2.2).
-  **Beep:** Opción que permite deshabilitar el zumbador. Por defecto, habilitado.
-  **RABC/Trazabilidad:** Se registrará la información de cada lavado, guardando la información (Ver apartado 4.2).
-  **Periodo de Gracia:** Al pulsar este botón tendremos una pantalla intermedia para poder activar o desactivar el periodo de gracia y poder editar el valor entre 1 y 99 minutos (por defecto habilitado y 1 minuto).

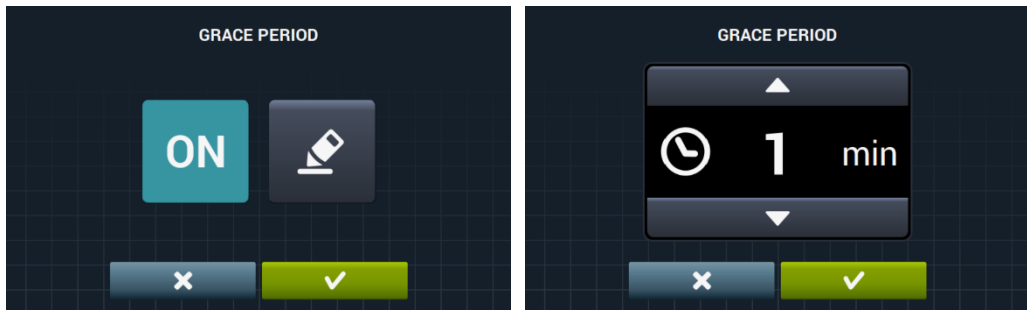

-  **Estadísticas de autoservicio:** Permite obtener datos de recaudación y número de ejecuciones de cada uno de los programas de favoritos. Al pulsar en el botón de estadísticas de autoservicio, se muestra la siguiente pantalla.

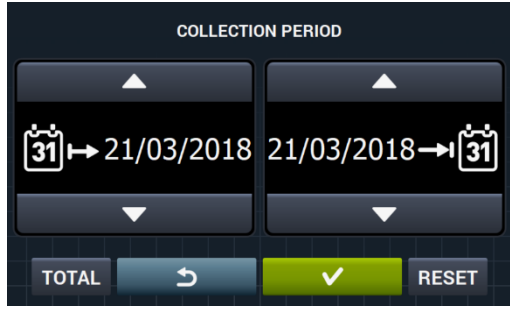

Pulsando en "TOTAL", se mostrarán los valores totales de la máquina. Si se introduce una fecha, se mostrarán las estadísticas de ese periodo únicamente. Pulsando "Reset" se pondrán a 0 todos los valores, reseteando las estadísticas.





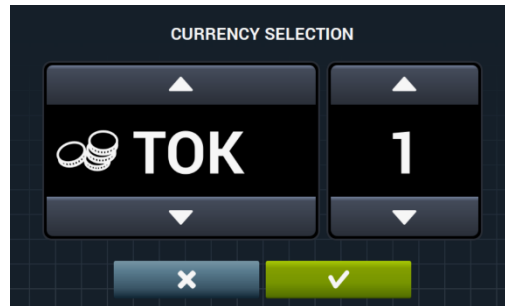

- 
Divisa: Permite seleccionar el tipo de divisa en el que se quiere trabajar y modificar el valor de pulso de esta (ver apartado 9.2.3). Si se cambia de divisa, todos los precios serán reseteados, por defecto a token.

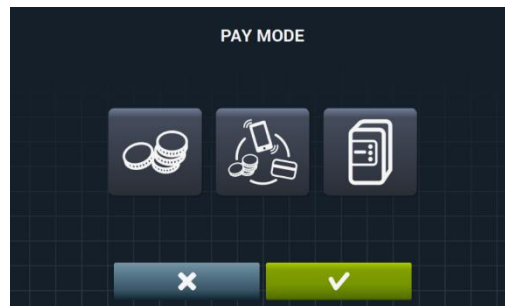

- 
Modo de Pago: Habrá 3 modos diferentes para trabajar en modo autoservicio.



- 
COIN: Habrá que configurar la divisa y el precio de cada programa, tratando los pulsos del monedero para habilitar la ejecución de un programa determinado.
- 
Central Payment: La lavadora recibirá un pulso desde un central de pago para liberar la lavadora y permitir la ejecución de un programa. Selección por defecto. Las opciones de divisa, precio y programación de precios estarán deshabilitadas.
- 
Multipago: Mismo comportamiento que la opción "COIN".

- 
Precios: Se podrán configurar los precios de todos los programas seleccionados en "Mis Programas". El valor mínimo del programa será el múltiplo definido en la divisa, mientras que el máximo será 100 veces el valor del múltiplo. Por defecto, el valor mínimo configurable.



Seleccionamos el programa o los programas que queremos modificar y pulsando en el botón  pasamos a la ventana para asignar el nuevo precio.



- 
Programación de precios: Además de la configuración básica de precios, habrá la posibilidad de realizar una programación de precios, esto es, periodos de tiempo concretos donde se quiere variar el precio definido de los programas. Máximo, 10 programaciones simultaneas.

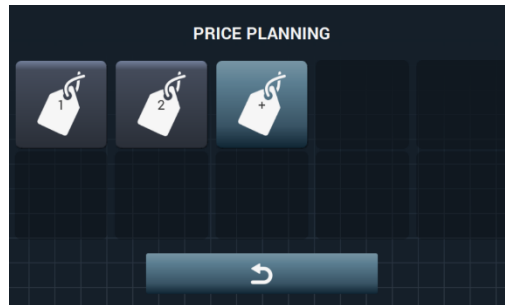

Los precios programados tendrán vigencia en el tramo horario configurado, volviendo a los precios generales una vez haya transcurrido el horario configurado.

Si existe algún conflicto entre distintas programaciones, se aplicará la condición del primer plan. Además, solamente se permitirá crear planes a partir de la fecha actual.

Al pulsar el botón  se crea un plan nuevo. Estos son los campos que se deberán rellenar a la hora de realizar una programación:

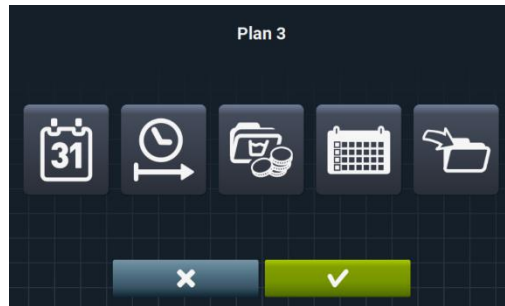

- 
Fecha: Periodo de tiempo en el que se quiere hacer la programación.

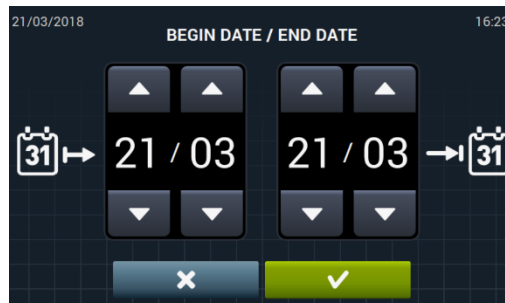

- 
Hora inicio/fin: Hora de comienzo y hora final de la programación realizada.

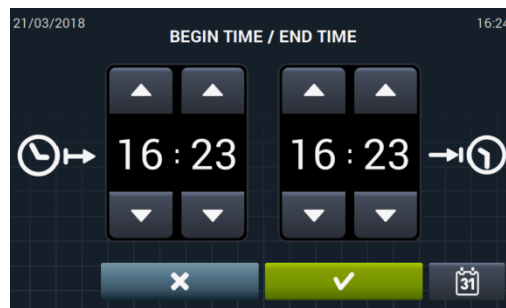

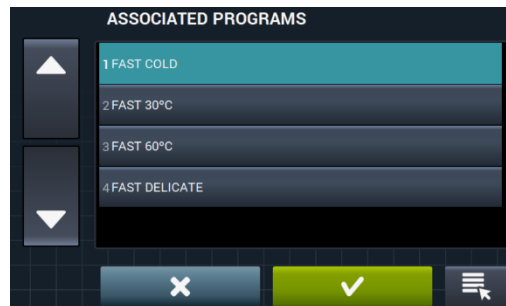

- 
Programa(s) y Precios: Precio o descuento que se le quiere asignar a cada uno de los programas existentes en "Mis Programas". Se le podrá asignar un precio fijo o aplicar un descuento a los programas seleccionados.

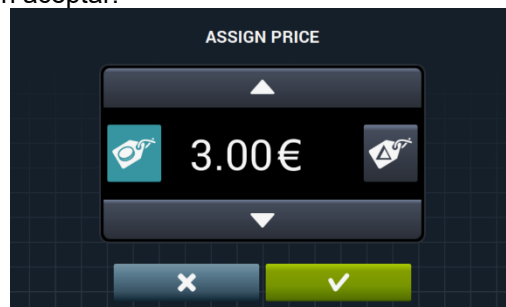

Para ello seleccionaremos el programa o los programas a los que se quiere aplicar la variación de precio y pulsamos en aceptar.



- 
Precio fijo: A todos los programas que hayamos seleccionado se les aplicara el precio definido.
- 
Descuento: A todos los programas que hayamos seleccionado se les aplicará el descuento definido.
- 
Calendario: Dentro de la fecha indicada, días en el que se quiere aplicar la programación realizada.

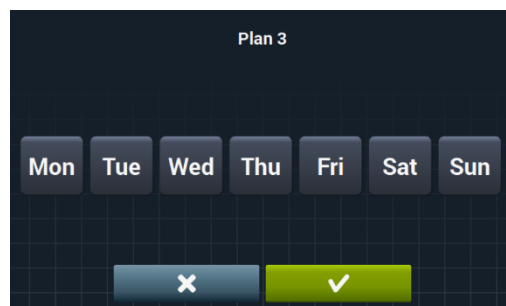

- 
Importar: Aparte de meter todos los campos uno a uno, existirá la posibilidad de importar un plan existente desde una memoria USB.

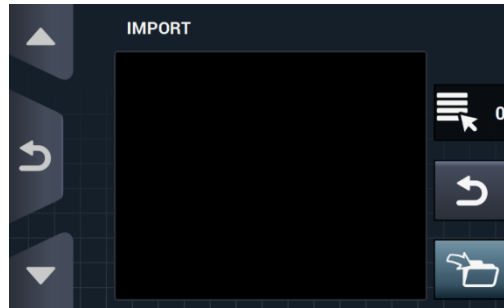

Si seleccionamos IMPORTAR, se nos mostrará la misma pantalla que en programas para poder navegar por el USB, pero solamente se podrán seleccionar ficheros de planes de precio (extensión .plan). A la hora de importar, solamente se podrá importar un plan. Al pulsar OK e importar el plan, se volverá a la pantalla principal de planes de precios.

Al pulsar el botón de uno de los planes activos , se mostrará un resumen de los parámetros configurados.

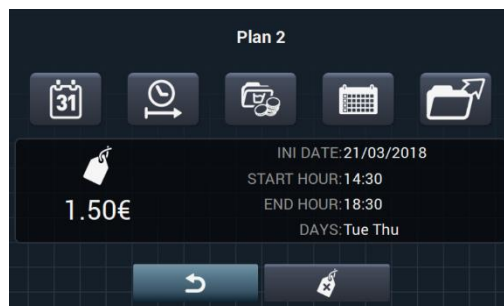

Se podrán cambiar los parámetros anteriormente descritos uno a uno pulsando el botón correspondiente.

Además, existe un botón de “Exportar”  para poder exportar ese plan (en un fichero de extensión .plan) al directorio raíz de la memoria USB.

Se guardarán los ficheros de planes de precios en una carpeta llamada “PRICE PLANS” en el directorio raíz del USB.

Cada fichero de planes de precio se llamará la forma: PLAN_Nº_Fecha_hora.plan (PLAN_3_20151029_112346.plan por ejemplo).

Se puede eliminar el plan, pulsando en el botón de borrar .

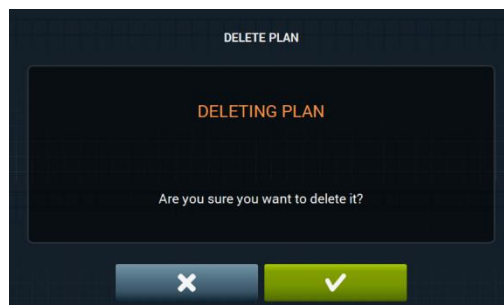

9.2.2 Programación HUD

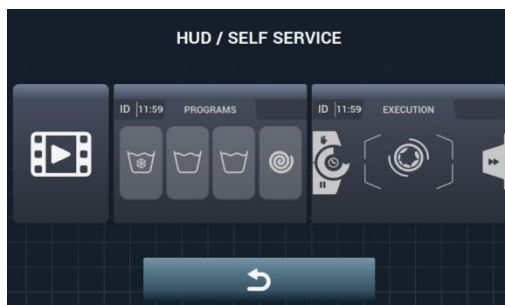

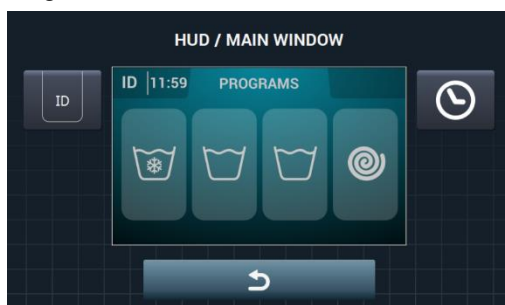

-  **Pantalla principal:** Será aplicable a ambas pantallas de selección de autoservicio. Permite configurar los parámetros siguientes:



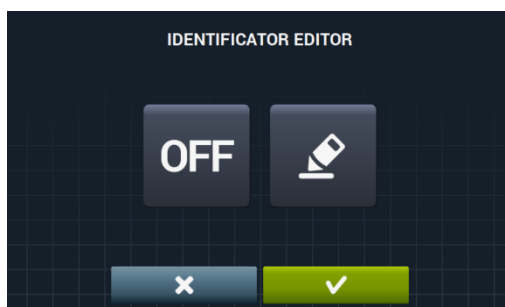

-  **Identificador de máquina:** Se podrá habilitar/deshabilitar y configurar la identificación de máquina. Por defecto, deshabilitado.



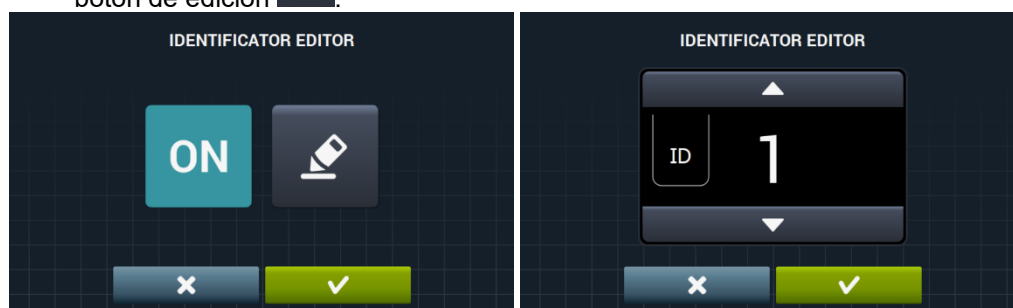



Se habilita el identificador de la máquina pulsando en el botón "OFF"  y después en el botón de edición .





-  **Hora:** Mostrar/ocultar hora actual. Por defecto, habilitado.

- 
Pantalla de ejecución: A continuación se muestran las opciones configurables:

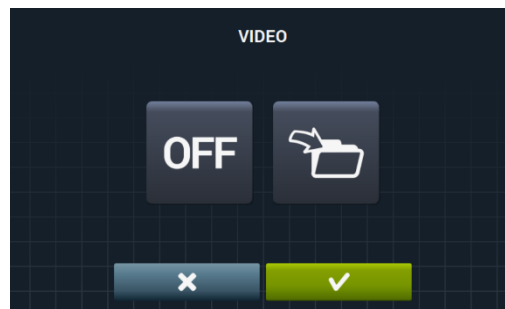

- 
Hora: Opción que permite mostrar/ocultar la hora. Por defecto, habilitado.
- 
Tiempo restante: Opción para mostrar/ocultar el tiempo restante total y el indicador de progreso del programa. Por defecto, habilitado.
- 
Identificador de máquina: Se podrá habilitar/deshabilitar la identificación de máquina. Por defecto, deshabilitado.
- 
STOP: Permite mostrar el botón de parada. Por defecto, deshabilitado.
- 
Importar video: Permite reproducir un video en la pantalla de la máquina después de 10 minutos de inactividad. Si se activa el "Ahorro de energía" automáticamente se desactiva la reproducción del video.



Pulsando en el botón importar , se puede importar un video a la máquina desde una memoria USB externa, solamente se podrán importar archivos de video (avi, mov,...), y solo se podrá tener un archivo de video instalado en la máquina. La resolución recomendada de los videos será, para las máquinas con pantalla de 4,3" de 480x272 pixeles, y para las máquinas con pantalla de 7" de 800x480 pixeles. No se aconseja que supere los 16 Fps. El tamaño máximo del archivo no debe superar los 25Mb.

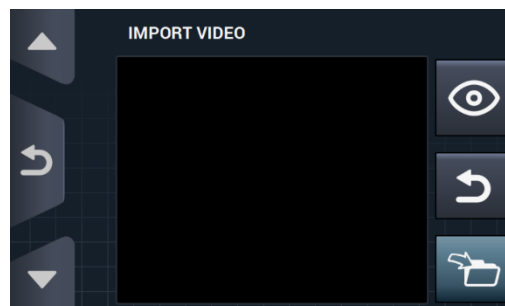

El botón previsualizar , nos permite comprobar la correcta reproducción del archivo de video.

9.2.3 Tabla de divisas

Esta es la tabla de todas las monedas disponibles con el correspondiente símbolo y pulso (múltiplo). Si se elige un valor de pulso diferente al de por defecto, se tendrá que adaptar el monedero a este valor. Es responsabilidad del usuario hacerlo. Por defecto los monederos suministrados tienen configurados estos valores:

PAIS	MONEDA	ISO	SÍMBOLO	Valor/PULSO
Token	Token	TOK	\$	1
Kuwait	Dinar Kuwaití	KWD	ك.د.	0,05
Oman	Rial Omani	OMR	ر.ع.	
Azerbaiyan	Manat	AZN	m	0,1
Bulgaria	Lev	BGN	лв	
Bahrain	Dinar Bahraini	BHD	ب.د.	
China	Yuan Chino	CNY	¥	
Malaysia	Ringgit Malayo	MYR1	RM	
Panama	Balboa Panameño	PAB	B	
Argentina	Peso Argentino	ARS	\$	
Bermuda	Dólar de Bermudas	BMD	BD\$	
Brazil	Real	BRL	R\$	
Canada	Dólar de Canadá	CAD	C\$	
Egypt	Libra egipcia	EGP	ج.م.	
Ethiopia	Birr etiope	ETB	Br	
Guatemala	Quetzal	GTQ	Q	
Cayman Islands	Dólar de las islas Caimán	KYD	\$	
Saudi Arabia	Riyal Saudí	SAR	ر.س.	
El Salvador	Colón del Salvador	SVC	¢	
Turkey	Lira Turca	TRY	YTL	
United States	Dólar USA	USD	\$	
United Arab Emirates	Dirham de UAE	AED	إ.د.	
Bolivia	Boliviano	BOB	Bs	0,5
Estonia	Corona de Estonia	EEK	EEK	
Euro-Countries	Euro	EUR	€	
United Kingdom	Libra esterlina	GBP	£	
Georgia	Lari	GEL	ლარი	
Ghana	Cedi ghanes	GHS	GHS	
Croatia	Kuna Croata	HRK	kn	
New Zealand	Dólar Neozelandés	NZD	\$	
Qatar	Riyal Qatarí	QAR	ق.ر.	
Ukraine	Grivnia de Ucrania	UAH	\$	
Singapore	Dólar de Singapur	SGD	S\$	
Malaysia	Ringgit Malayo	MYR2	RM	

Boznia and Herzegovina	Marco Convertible	BAM	KM	1
Bangladesh	Taka de Bangladesh	BDT	Tk	
Switzerland	Franco Suizo	CHF	CHF	
Dominican Republic	Peso Dominicano	DOP	RD\$	
Hong Kong	Dólar de Hong Kong	HKD	HK\$	
Israel	Shekel Israelí	ILS	₪	
India	Rupia india	INR	Rs.	
Sri Lanka	Rupia de Sri Lanka	LKR	₹	
Morocco	Dirham marroquí	MAD	د.م.	
Macedonia	Dinar Macedonio	MKD	MKD	
Peru	Nuevo Sol Peruano	PEN	S/.	
Poland	Zloty polaco	PLN	zł	
Russian Federation	Rublo Ruso	RUB	руб	
Sweden	Corona sueca	SEK	kr	
Thailand	Baht tailandés	THB	฿	
Tunisia	Dinar tunecino	TND	ت.د.	
Uruguay	Peso Uruguayo	UYU	\$	
Serbia	Dinar serbio	RSD	дин.	
South Africa	Rand sudafricano	ZAR	R	
Australia	Dólar Australiano	AUD	\$	
Czech Republic	Corona Checa	CZK	Kč	5
Denmark	Corona Danesa	DKK	kr	
Kenya	Chelín keniano	KES	KSh	
Mexico	Peso mexicano	MXN	\$	
Norway	Corona Noruega	NOK	kr	
Romania	Leu rumano	RON	L	
Philippines	Peso Filipino	PHP	\$	
Algeria	Dinar argelino	DZD	د.د.	10
Guyana	Dólar de Guyana	GYD	GY\$	
Hungary	Florín Hungaro	HUF	Ft	
Iceland	Corona islandesa	ISK	kr	
Kazakhstan	Tengue Kazajo	KZT	T	
Taiwan	Dólar Taiwanés	TWD	NT\$	
Chile	Peso Chileno	CLP	\$	50
Costa Rica	Colon Costarricense	CRC	₡	
Iran	Rial Iraní	IRR		
Paraguay	Guaraní paraguayo	PYG	\$	
French Polynesia	Franco CFP	XPF	F	
Colombia	Peso Colombiano	COP	\$	100
Indonesia	Rupia indonesia	IDR	Rp	
Japan	Yen japonés	JPY	¥	
South Korea	Won coreano	KRW	₩	
Uganda	Chelín ugandés	UGX	USh	
Venezuela	Bolívar	VEF	Bs.	

10 MANTENIMIENTO

10.1 Errores

A continuación indicamos los errores que tienen acciones diferenciados para Autoservicio, el resto son iguales.

ERROR	DESCRIPCIÓN	CAUSA Y ACCIÓN
E6	FALLO CALENTAMIENTO	Se detecta que, a pesar de activar la salida de calentamiento, la temperatura del agua no aumenta durante 30 minutos. Existirá la posibilidad de anular este error. En ese caso, en vez de dar el error, avanzará como si hubiese alcanzado la temperatura. Mostrará un aviso pero no parará, seguirá con el programa pero el aviso se quedará hasta que finalice el programa y se abra la puerta.
E9	DESEQUILIBRIO	En la distribución del centrifugado final se activa 5 veces la entrada "Interruptor desequilibrio". No dará error y centrifugará a baja velocidad, el programa finalizará normalmente sin avisos.

INSTRUCTIONS DE SECURITE	2
1 UTILISATION.....	5
1.1 Recommandations d'utilisation.....	5
1.2 Utiliser le bac à produits	5
1.3 Caractéristiques machine	5
2 INTERFACE.....	6
2.1 Ecran OFF OPL	6
2.2 Ecran principal OPL.....	6
2.3 Ecran de fonctionnement OPL.....	7
3 PROGRAMMES.....	10
3.1 Paramètres cycles	10
3.1.1 Paramètres pour cycles de trempage, pré lavage, lavage ou rinçage:	10
3.1.2 Paramètre cycles d'essorage:.....	12
3.2 Bibliothèque cycles	13
3.3 Bibliothèque programmes.....	15
4 CONFIGURATION.....	16
4.1 Gestion de programmes.....	17
4.1.1 Mes programmes (favoris).....	17
4.1.2 Bibliothèque de programmes	18
4.1.3 Bibliothèque de cycles	21
4.2 Configuration Système.....	22
4.2.1 Configuration HUD.....	26
5 MAINTENANCE.....	30
5.1 Défauts électriques et mécaniques	30
5.2 Alarmes.....	30

INSTRUCTIONS DE SECURITE

Afin de réduire le risque de choc électrique ou de blessure lorsque vous utilisez l'appareil, les précautions de base doivent être observées, y compris ce qui suit:

- LIRE toutes les instructions avant d'utiliser l'appareil et les garder dans un endroit facilement accessible pour consultation en cas de doute.
- Ne lavez pas les vêtements qui ont été précédemment traités, lavés, trempés ou colorés avec de l'essence, des solvants de nettoyage à sec ou d'autres substances inflammables ou explosives, car ils comportent des vapeurs qui peuvent s'enflammer ou exploser.
- N'ajoutez pas d'essence, de solvants de nettoyage à sec ou autres matières inflammables à l'eau de lavage. Ces substances peuvent émettre des vapeurs qui peuvent s'enflammer ou exploser.
- Dans certaines conditions, du gaz d'hydrogène peut être produit dans un circuit d'eau chaude qui n'a pas été utilisé pendant plus de deux semaines. Le gaz hydrogène est explosif. Si le système d'eau chaude n'a pas été utilisé pendant un certain temps, avant d'utiliser la machine à laver, ouvrez tous les robinets d'eau chaude et laissez l'eau couler pendant quelques minutes. Cela permet de libérer tout l'hydrogène accumulé. Comme le gaz est inflammable, ne pas fumer ou utiliser des flammes nues au cours de cette opération.
- Cet appareil peut être utilisé par des enfants de 8 ans et plus, et par des personnes à capacités physiques, sensorielles ou mentales réduites ou manquant d'expérience et de connaissances, si elles ont été surveillées ou formées correctement en ce qui concerne l'utilisation de l'appareil de façon sûre et en comprenant les dangers. Le nettoyage et l'entretien à réaliser par l'utilisateur ne doivent pas être effectués par des enfants sans surveillance.

- Ne laissez pas les enfants jouer dans ou sur l'appareil. Les enfants doivent être étroitement surveillés quand ils se trouvent à proximité d'une machine qui fonctionne. Les enfants de moins de 3 ans doivent être tenus à l'écart, sauf en cas d'être constamment surveillés.
- Enlevez la porte de l'appareil avant de jeter ou de mettre la machine hors service.
- **NE PAS ESSAYER D'OUVRIR** la porte si le tambour est en mouvement.
- Ne pas installer ou conserver l'appareil à l'air libre.
- N'essayez pas de forcer les contrôles.
- Les nouveaux tuyaux fournis avec l'appareil doivent être utilisés, ne pas utiliser d'anciens tuyaux.
- Ne pas réparer ou remplacer les pièces de l'appareil ni effectuer aucune opération d'entretien qui ne serait pas recommandée dans le manuel de l'utilisateur. Assurez-vous que vous comprenez les instructions entièrement et avez les compétences nécessaires pour effectuer les opérations décrites.
- N'enlevez aucun dispositif de sécurité ou ne modifier aucun des composants dans la machine à laver. N'installez pas de composants n'appartenant pas à la machine dans l'appareil.
- L'omission de satisfaire à toutes les instructions fournies dans le manuel d'instructions peut entraîner des blessures corporelles à l'utilisateur. Il n'est pas possible de prévoir toutes les situations possibles et les éventualités avec des avertissements sur les risques et les dangers. Par conséquent, toute personne impliquée dans le transport, l'installation, l'utilisation ou la maintenance de l'appareil devrait toujours faire acte de bon sens, de prudence et de soins.

- Ne pas utiliser la machine, à moins que toutes les panneaux et les grilles soient correctement montés et sécurisés.
- Le distributeur (vendeur) doit former correctement l'utilisateur au cours de la mise en service.
- Versez les doses correctes de détergent, d'assouplissant dans le tiroir à produits lessiviels tel qu'indiqué par le fabricant. Tenez compte des conseils concernant le traitement des différents matériaux donnés par les fabricants.
- Tous les jours, toute trace de détergent ou de liquides doit être nettoyée. Retirez le tiroir à produits lessiviels. N'utilisez jamais de détergents en poudre ou abrasifs pour le nettoyage ; utilisez uniquement de l'eau et du savon.
- Nettoyez les filtres d'entrée d'eau et le bac à produits externe une fois par mois.
- Ne jamais nettoyer l'extérieur par injection d'eau ; risque d'endommager les parties fonctionnelles de la machine.
- Si la machine à laver doit être inactive pendant de longues périodes, appliquez une couche de Vaseline sur toutes ses surfaces en acier inoxydable.
- Une révision générale annuelle est recommandée.

1 UTILISATION

1.1 Recommandations d'utilisation

Cette machine a été conçue pour laver ou traiter la plupart des matériaux. Son utilisation à d'autres fins que celles énoncées est considérée comme abusive et dangereuse.

La machine doit être chargée avec la charge nominale, de plus petites ou plus grandes charges sont à proscrire.

Les vêtements ne doivent pas être lavés dans des sacs ou des sacs en tissu. Si cela est absolument nécessaire, assurez-vous que la machine est chargée à la charge nominale pour éviter de possibles charges déséquilibrées.





Les toiles, pièces étanches, mops, moquettes ou tapis ne doivent pas être essorés.

Quand un programme se termine, avant l'ouverture de porte, les vêtements sont démêlés pendant 30 secondes. Un signal sonore s'entend lorsque la porte peut être ouverte après ce processus.

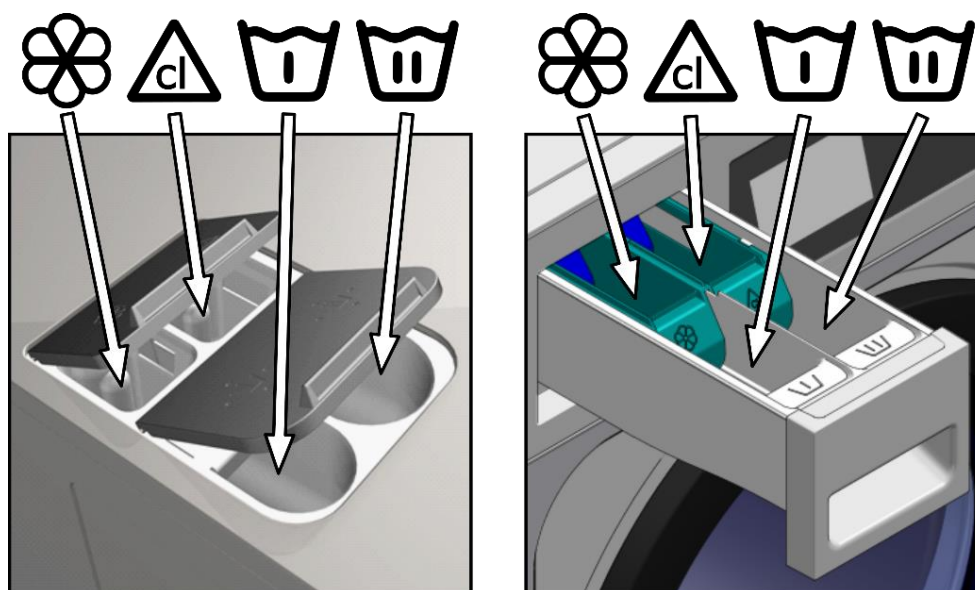
1.2 Utiliser le bac à produits

Ajouter les produits de lavage dans chaque compartiment et fermer le couvercle du distributeur.



-  Détergent en poudre pour le pré-lavage
-  Détergent en poudre pour le lavage
-  Assouplissant liquide
-  Désinfectant (Javel)

1.3 Caractéristiques machine

La machine est contrôlée à l'aide d'un microprocesseur capable de s'adapter aux besoins de chaque utilisateur.

La machine possède un réglage intelligent pour contrôler la température de l'eau ; Si l'eau chaude est disponible, elle doit être branchée. La machine permet d'ajuster les apports d'eau différents pour maintenir la température programmée.

Elle a un contrôle intelligent de la gestion du cycle de rotation. La machine à laver contrôle toute charge déséquilibrée et gère la rotation afin d'assurer un bon essorage, réduisant le bruit et prolongeant la durée de vie des composants, réduisant ainsi considérablement la fatigue mécanique.

2 INTERFACE

Toutes les machines à laver ont un écran tactile affichant toutes les informations et d'où il est possible de sélectionner toutes les commandes affichées à l'écran.

Lorsque la machine est en marche, écran OFF s'affiche. Le bouton ON/OFF dirige l'utilisateur vers l'écran principal, d'où il est possible d'exécuter un programme ou aller dans le menu principal. Appuyez sur START pour passer à l'écran de fonctionnement, qui affiche toutes les informations pertinentes sur l'écran.

Appuyer sur ON/OFF pour revenir à l'écran précédent.

Les informations affichées sur chacun des écrans peuvent être désactivées ou activées dans le menu HUD (voir la section 4.2.1)

2.1 Ecran OFF OPL

Cet écran s'affiche lorsque la machine à laver n'est pas en fonction, montrant les paramètres configurés par l'utilisateur.

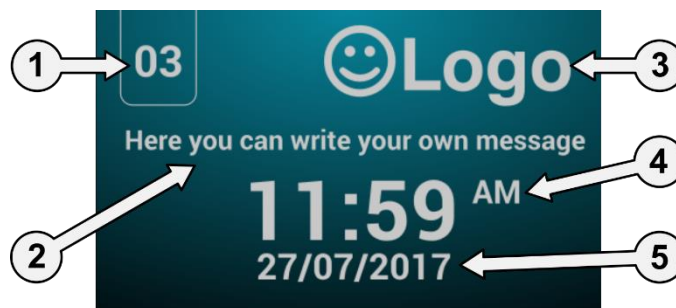

1. **Identification machine:** Etiquette d'identification de la machine (si activé)
2. **Message laverie:** Message configuré par l'utilisateur (si activé)
3. **Logo:** Le logo s'affiche (si activé)
4. **Temps:** heures et minutes dans le format choisi.
5. **Date:** Date dans le format choisi (si activé dans le HUD)

Si l'option « économie d'énergie » est actif, 10 minutes après avoir éteint la machine à laver, le rétroéclairage de l'écran s'éteint. Si une partie quelconque de l'écran est touchée, le rétro-éclairage s'allume à nouveau. De même, si vous appuyez sur le bouton ON/OFF, le rétro-éclairage s'allume et l'écran principal est ouvert.

2.2 Ecran principal OPL

L'écran principal de la machine à laver est le suivant et affiche chacune des options disponibles. Certaines de ces options peuvent être désactivées dans le menu HUD.



1. **Identification machine:** Etiquette d'identification de la machine.
2. **Temps:** Heures et minutes dans le format choisi.
3. **Poids du linge:** Le poids du linge dans la machine s'affiche (si le kit de pesage est actif) ou la charge nominale pour le modèle sélectionné (si le kit n'est pas actif) et le poids de la charge d'entrée peut être éditée. Option pour activer/désactiver dans le HUD. Une fois que le programme a pris fin ou est abandonné, la charge nominale de la machine est à nouveau sélectionnée.
4.  **Menu principal:** Accès au menu principal de la machine à laver où différents paramètres machine peuvent être configurés.
5. **Nom programme:** Nom configuré pour le programme sélectionné.
6. **T Température programme:** Température maximale des différents cycles du programme.
7. **No et durée du programme:** Position du programme dans la liste des programmes (mes Programmes) et la durée approximative en minutes pour le programme sélectionné.
8. **Augmenter/diminuer No programme:** Permet à l'utilisateur de faire défiler vers le haut ou vers le bas la liste des programmes sélectionnés. Ainsi en utilisant les boutons, le programme peut être augmenté/diminué en appuyant directement sur les informations sur les programmes (juste au-dessus de la touche).
9. **Start:** Bouton pour démarrer le programme sélectionné du cycle indiqué.
10. **Phases programme:** Appuyer sur l'icône du programme sélectionné affichera les phases dont est composé le programme et permettra de sélectionner la phase de démarrage.
En outre, il est possible de configurer un programme instantanément, c'est-à-dire, changer les paramètres d'un cycle (temps, température, niveau et posologie) pour le programme en cours. Ces valeurs ne sont pas enregistrées pour les cycles des programmes futurs.

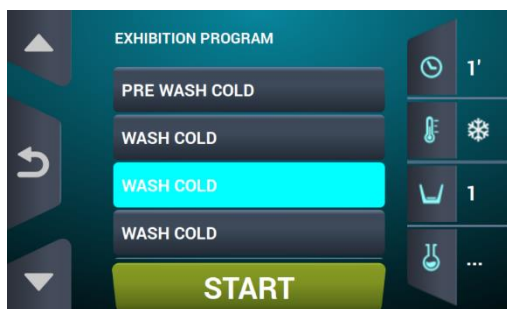





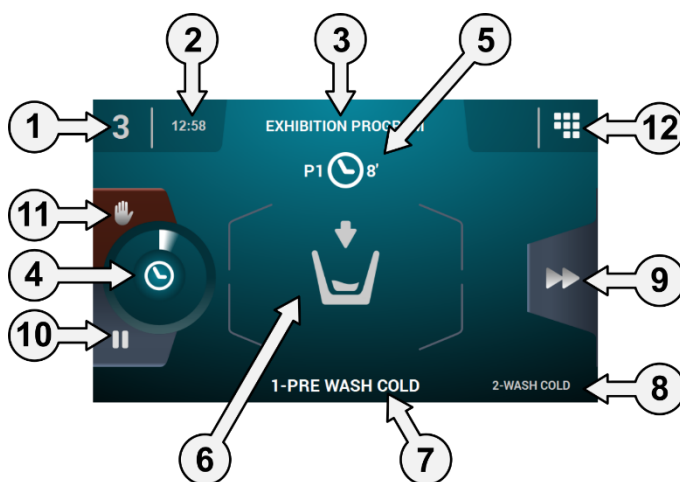









2.3 Ecran de fonctionnement OPL

Lorsque vous appuyez sur START, le programme démarre et toutes les informations correspondantes du programme s'affichent sur l'écran. Certaines de ces options peuvent être désactivées dans le menu HUD.





1. **Identification machine:** Etiquette d'identification de la machine.
2. **Temps:** heures et minutes dans le format choisi.
3. **Programme en fonction:** Nom du programme, numéro de Programme, durée de Programme.
4. **Indicateur de progression de programme:** État de progression du programme, rapport entre le temps total et le temps restant du programme.

5. **Numéro et durée de programme:** Position du programme dans la liste de programmes (Mes programmes), et durée, en minutes, estimée pour le programme sélectionné.
6. **État (dessin):** Dessin animé indiquant ce que le lave-linge réalise (remplissage, vidange, rinçage, essorage ou défroissage).

	Ouverture de porte.		Basculement avant.
	Chauffage en cours		Basculement arrière.
	Défroissage.		Essorage en cours.
	Refroidissement en cours.		Fin de la phase en cours.
	Remplissage en cours.		Lavage en cours.
	Arrêt en cours.		Arrêt programmé.
	Extraction du linge en cours.		Vidange en cours.

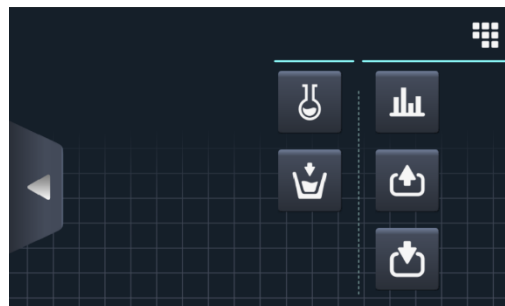
7. **Cycle en cours:** Identification et nom du cycle en cours d'exécution.
8. **Prochain cycle:** Identification, nom et dessin du prochain cycle (si le cycle en cours est le dernier cycle, rien ne s'affiche).
9. **Avance cycle:** Bouton pour aller au prochain cycle (si le cycle en cours est le dernier cycle, rien ne s'affiche). Ainsi à l'aide de la touche, le cycle peut être avancé en appuyant directement sur l'information pour le prochain cycle (juste au-dessus de la touche).
10. **Pause:** Bouton pour interrompre le programme en cours. Si le programme est suspendu, l'icône de pause va se changer en icône de lecture. Le programme peut être redémarré à partir de là où il a été interrompu.
11. **Stop:** Bouton pour arrêter et annuler le programme. Un message de confirmation sera demandé.
12.  **Menu de fonctionnement:** Accès aux paramètres actuels.



-  **Entrées:** Le statut de chacune des entrées s'affiche. Les entrées qui sont disponibles dans toutes les machines sont toujours affichées. Les entrées qui sont exclusives à une fonction particulière (par exemple, libre-service, sanitaire, pompes, réservoirs (T1, T2, T3), inclinaison...) ne sera disponible que si cette fonction est activée.

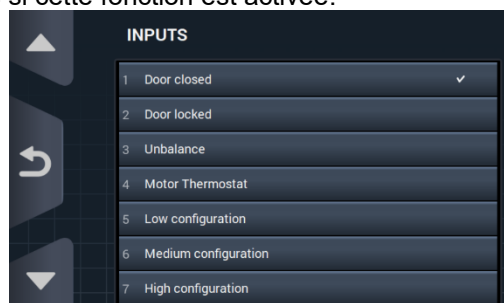

- 
Sorties: L'état de chacune des sorties est affiché. Les sorties qui sont disponibles dans toutes les machines sont toujours affichées. Les sorties qui sont exclusives à une fonction particulière (par exemple, libre-service, sanitaire, pompes, réservoirs (T1, T2, T3), inclinaison...) ne seront disponibles que si cette fonction est activée.

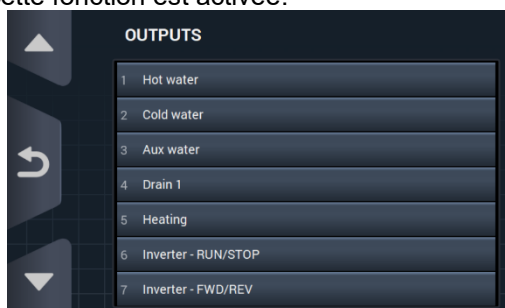

- 
Paramètres/Valeurs: Affichage des paramètres et des valeurs réelles pour le cycle actuel (température, niveau, temps restant). Appuyer sur les boutons de la colonne de droite permet de modifier les valeurs de consigne, en n'affectant que l'exécution en cours.

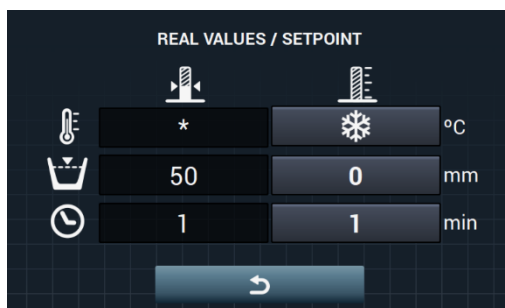

- 
Dosage manuel: Cette section est accessible, l'état de chaque distributeur (ON/OFF) s'affiche, et la dose nécessaire peut être activée/désactivée. Les options disponibles s'appuient sur la configuration des kits existants. En sortant de la fenêtre de dosage, tous les distributeurs sont désactivés.



- 
Entrée d'eau manuelle: Cette section est accessible, l'état de chaque entrée d'eau (ON/OFF) est affichée, et l'entrée requise peut être activée/désactivée. L'arrivée d'eau qui a été activée par le logarithme de remplissage ne peut pas être désactivée. En sortant de la fenêtre d'entrée de l'eau, toutes les entrées d'eau activées manuellement seront désactivées.

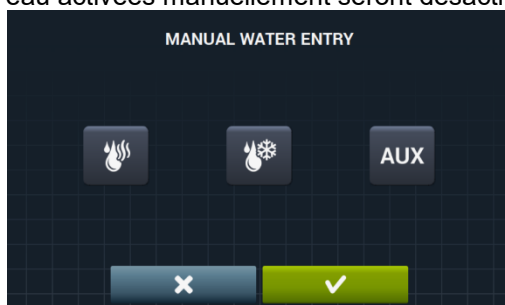

3 PROGRAMMES

Il existe une bibliothèque de programmes composés de tous les programmes installés par défaut ainsi que les programmes créés par l'utilisateur.





Avant d'expliquer la gestion des programmes (voir section 4.1), les détails de leurs paramètres et les programmes standards présents dans la bibliothèque sont indiqués.





3.1 Paramètres cycles

Chaque programme est composé d'une série de cycles, consistant en un ensemble de paramètres qui peuvent être configurés selon le type de cycle en question.

3.1.1 Paramètres pour cycles de trempage, prélavage, lavage ou rinçage:



- Nom cycle:** Nom identifiant le cycle. Ce n'est pas le texte affiché sur l'écran, mais le texte qui identifie un cycle créé.
- 
Temps: Valeur, en minutes, de la longueur du cycle. Plage configurable de 1 à 99.
- 
Temperature: Température en °C ou °F du cycle actuel.
- Peut être configuré de 20°C (68°F) à 90°C (194°F).
- 
Niveau: Niveau d'eau avec lequel le cycle doit être exécuté. Plages configurables (voir section 4.2). Il existe 5 types de niveau : Minimum (1), faible (2), moyen (3), haut (4) Maximum (5).
- 
Vitesse: Vitesse du cycle en cours. Plages configurables (voir section 4.2). Il y a 4 vitesses différentes au choix : Minimum (1), faible (2), normale (3), haute (4).
- 
Taux lavage: Séquence de mouvement que la machine à laver doit suivre (temps (secondes) d'exécution / temps de pause (secondes)). Peut être configuré de 1 à 99. Le tambour tourne alternativement de gauche à droite.

- 
Entrée d'eau: indique la sélection d'entrée d'eau requise.
 - Eau chaude : prendre l'eau à partir de l'arrivée d'eau chaude (oui/non).
 - Eau froide : prendre l'eau à partir de l'entrée d'eau froide (oui/non).
 - Auxiliaire : prendre l'eau à partir de l'entrée d'eau adoucie (oui/non).
 - Ajustement de l'eau : prendre l'eau de l'une ou l'autre admission selon la température (oui/non).
 - T1, T2, T3: prendre l'eau depuis les réservoirs si la machine est équipée du KIT récupération d'eau.
- 
Vidange: indique si l'eau doit être vidée à la fin du cycle, indiquant quelle prise doit être utilisée si le kit de récupération est actif.
- 
Refroidissement: Option qui permet à la température de s'abaisser dans un cycle avant la vidange ou d'aller au cycle suivant. Paramètre configurable uniquement si la température du cycle est égale ou supérieure à 40°C (104°F). Peut être configuré à partir de 30°C (86°F) dans le réglage du cycle.
En plus de choisir la valeur de refroidissement, il y a un bouton pour activer ou désactiver cette option.
- 
Distributeur 1.8: Chaque compartiment peut être activé indépendamment et les paramètres suivants doivent être configurés lorsqu'il est activé:
 - Start: Si le distributeur X est actif, indiquer quand ce distributeur doit commencer à doser.



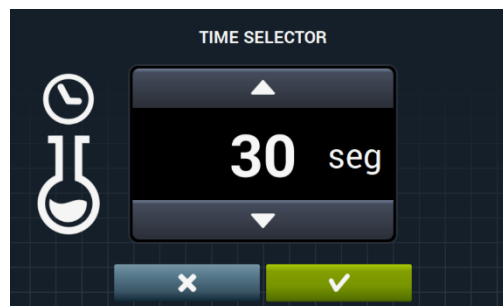

- Niveau de sécurité (ML): commencez le dosage quand le niveau de sécurité est atteint.
 - Niveau (L): Démarrez lorsque le niveau défini de dosage est atteint.
 - Temperature (T): Commencez le dosage lorsque la température définie est atteinte.
- T Temps : Temps, en secondes, du distributeur X. distributeur peut être configuré de 0 à 99.



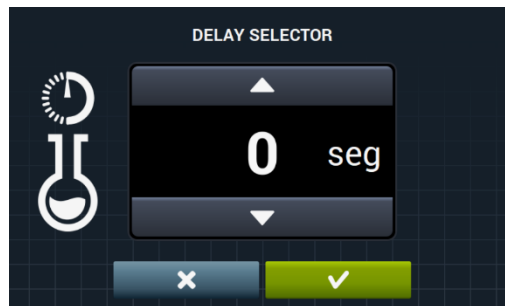

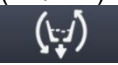



- Délai : Délai, en secondes, du distributeur de X. à partir du moment où que le programme a atteint le point de départ indiqué, le dosage sera retardé par rapport à l'heure indiquée. Plage configurable de 0 à (cycle de temps, temps de dosage).

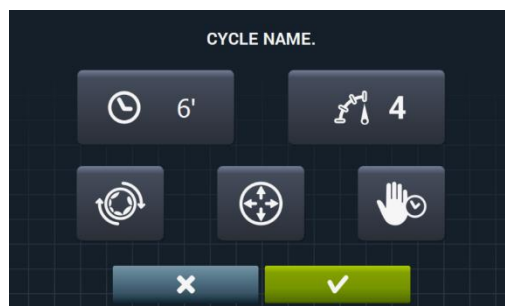

-  **rotation pendant remplissage:** rotation du tambour pendant que la machine se remplit (oui/non)
-  **Rotation pendant vidange:** rotation du tambour pendant que la machine se vide (oui/non)
-  **Arrêt thermique:** Indiquez le moment où le délai stipulé pour le cycle est compté (oui/non)
-  **Pause programme:** Cela permet de mettre en pause le programme avant que le cycle en question commence à fonctionner. La pause sera indiquée sur l'écran et un signal sonore est émis. (Oui/non)
Si ce paramètre est actif, avant de commencer le cycle, la machine ira au statut de pause et le message « Pause programmée » s'affiche sur l'écran. Pour continuer à exécuter le programme, appuyez sur le bouton PLAY.

3.1.2 Paramètre cycles d'essorage:











-  **Temps:** Valeur en minutes de la longueur de l'essorage. Plage configurable de 1 à 99.
-  **Vitesse:** Essorage vitesse. Il y a 4 vitesses différentes au choix : Minimum (1), Normal (2), moyen (3), Maximum (4).
Les valeurs moyenne (3) et maximale (4) sont disponibles uniquement dans les machines de haute et moyenne vitesse respectivement.
Les vitesses peuvent être configurées.
-  **Démêlage:** Démêler à la fin de l'essorage (oui/non).
-  **Distribution optimale:** Si cette option est active, la machine ne vidange pas lors du cycle précédent.
-  **Pause programme:** Cela permet de mettre en pause le programme avant que le cycle en question commence à fonctionner. La pause sera indiquée sur l'écran et un signal sonore est émis. (Oui/non).

3.2 Bibliothèque cycles















Ce sont les cycles présents par défaut dans la bibliothèque de cycles. Ces cycles peuvent être utilisés pour former les nouveaux programmes.

- Cycles trempage
 - **F1**: trempage
- Cycles prélavage
 - **F2**: Prélavage normal à froid
 - **F3**: Prélavage normal (104°F)
 - **F4**: Prélavage délicat à froid
 - **F5**: Prélavage délicat 40°C (104°F)
 - **F6**: Prélavage très délicat à froid
 - **F7**: Prélavage très délicat (104°F)
 - **F8**: Prélavage humide
- Cycles lavage
 - **F9**: Lavage normal froid
 - **F10**: Lavage normal 60°C (140°F)
 - **F11**: Lavage normal 90°C (194°F)
 - **F12**: Lavage délicat à froid
 - **F13**: Lavage délicat 40°C (104°F)
 - **F14**: Lavage délicat à froid
 - **F15**: Lavage délicat 40°C (104°F)
 - **F16**: Lavage humide à froid
 - **F17**: Humide lavage (104°F)
- Cycles rinçage
 - **F18**: Rinçage normal
 - **F19**: Rinçage final normal
 - **F20**: Rinçage délicat
 - **F21**: Rinçage Final délicat
 - **F22**: Rinçage très délicat
 - **F23**: Rinçage Final très délicat
 - **F24**: Rinçage humide
 - **F25**: Rinçage final humide
- Cycles essorage
 - **F26**: essorage court
 - **F27**: essorage long











































































































Symboles cycles:

	Trempage	
	Prélavage	 : pré-lavage à froid,  40: pré-lavage 40°C (104°F),
	Lavage	...
	Rinçage	 : rinçage,  : rinçage final avec adoucissant
	Essorage	

Symboles et valeurs des paramètres:

	temps	Valeurs en minutes
	Temperature	Valeur en °C (°F)
	Niveau	1:minimum, 2:bas, 3: Moyen, 4:Haut, 5:Maximum
	Vitesse lavage	1:minimum, 2:bas, 3:Normal, 4:haut
	Vitesse essorage	2:Normal, 3:Medium 4:Maximum
	Entrée eau	0:froid, 1:froid / chaud selon ajustement
	Taux lavage	Temps pause (secondes) temps action (secondes).
	Rotation remplissage	✓ : oui
	Arrêt thermique	✓ : oui
	Rotation vidange	✓ : oui
	Vidange	✓ : oui
	Refroidissement	✓ : oui
	Distribution optimale	✓ : oui
	Arrêt programme	✓ : oui
	Démêlage	✓ : oui
D	distribution	Entrée selon dosage entre (D1:Distributeur 1,...) avec START // temporisation programmée à ML/0/30

Tableaux des cycles avec leurs paramètres:

	F1		F2		F3		F4		F5		F6		F7		F8
					40										
	3		5		5		6		6		6		6		5
	3				40				40				40		
	3		1		1		3		3		3		3		3
	0		3		3		2		2		2		2		1
	15;05		0		1		0		1		0		1		0
	✓		15;05		15;05		10;08		08;06		5;15		5;15		02;02
	✓		✓		✓										✓
	✓				✓				✓				✓		
			✓		✓				✓				✓		
			✓		✓		✓		✓		✓		✓		✓
			✓		✓		✓		✓		✓		✓		✓
D		D	D1	D	D1	D	D1	D	D1	D	D1	D	D1	D	D1

	F9	F10	F11	F12	F13	F14	F15	F16	F17
		60	90		40		40		40
	10	10	10	12	12	12	12	10	10
		60	90		40		40		40
	1	1	1	1	1	1	1	2	2
	3	3	3	2	2	2	2	1	1
	0	1	1	0	1	0	1	0	1
	15;05	15;05	15;05	10;08	10;08	05;15	05;15	02;02	02;02
	✓	✓	✓					✓	✓
		✓	✓		✓		✓		✓
	✓	✓	✓					✓	✓
	✓	✓	✓	✓	✓	✓	✓	✓	✓
D	D2, D3	D2, D3	D2, D3	D2	D2	D2	D2	D2	D2

	F18	F19	F20	F21	F22	F23	F24	F25
	2	2	3	3	3	3	2	2
	4	4	4	4	4	4	4	4
	3	3	2	2	2	2	1	1
	15;05	15;05	10;08	10;08	05;15	05;15	02;02	02;02
	✓	✓					✓	✓
	✓	✓					✓	✓
	✓	✓	✓	✓	✓	✓	✓	✓
D		D4		D4		D4		D4

	F26	F27
	2	6
	2	4
	✓	✓
	✓	✓

3.3 Bibliothèque programmes

Ce sont les programmes qui se trouvent par défaut dans la bibliothèque de programmes:

P1: fort (194°F)	P10: très délicat à froid
P2: fort 60°C (140°F)	P11: Economique 90°C (194°F)
P3: fort 30°C (86°F)	P12: Economique 60°C (140°F)
P4: fort à froid	P13: Economique 30°C (86°F)
P5: Normal 60°C (140°F)	P14: Economique à froid
P6: Normal 30°C (86°F)	P15: eau claire
P7: Normal à froid	P16: essorage long
P8: Délicat 40°C (104°F)	P17: essorage court
P9: Délicat à froid	



Le tableau de tous les programmes avec leurs paramètres se trouvent dans les dernières pages du manuel.

4 CONFIGURATION

Le menu de configuration principal de la machine à laver est illustré ci-dessous. Ici, il est possible de configurer différents paramètres de la machine à laver et d'afficher ou de télécharger des données stockées.

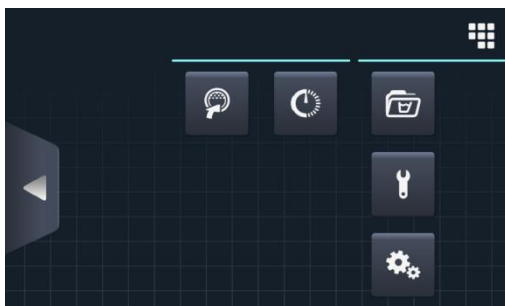
Ce menu est entré depuis l'icône  dans l'écran principal (voir la section 2.2)





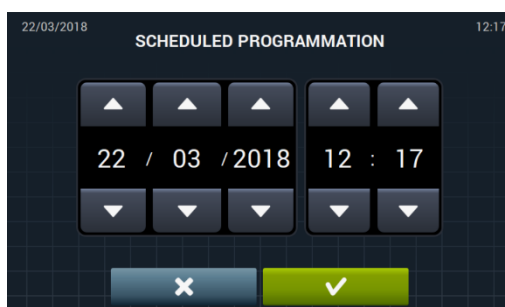

-  **Easy load:** Option qui aide à charger le linge.
-  **Programmation différée:** Permet de différer un lavage pour qu'il soit exécuté à la date/heure souhaitée. Après avoir appuyer sur le bouton « programmation différée », il faudra saisir la date/heure souhaitée.

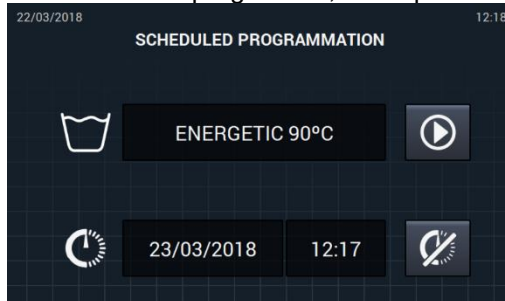

Un écran indiquant la date/heure du programme, ainsi que son numéro et son nom, apparaît.



-  Exécuter le programme avant l'heure prévue.
-  Annuler la programmation réalisée.
-  **Gestion de programme:** Gestion de tous les programmes stockés et tous les programmes actifs. (Voir section 4.1)
-  **Configurations système:** Configuration des différentes parties de la machine à laver. (Voir section 4.2)
-  **Maintenance:** options de mot de passe pour le technicien.



4.1 Gestion de programmes

Dans ce sous-menu, il est possible de gérer tous les programmes, aussi bien ceux choisis par l'utilisateur que ceux qui se trouvent dans la bibliothèque. Pour ce faire, sélectionnez entre « Bibliothèque du Cycle », « Mes programmes » et « Bibliothèque de Programme ».

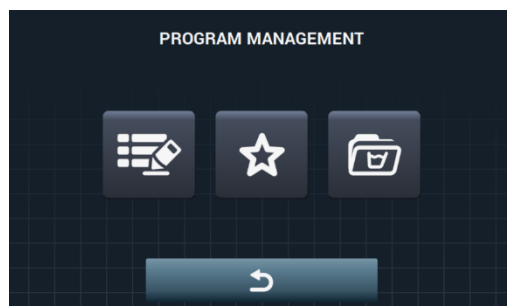
Accès: [écran principal]  ⇒ [menu principal] 



Il existe une bibliothèque dans laquelle sont stockés tous les programmes et les cycles, y compris les programmes stockés par défaut et programmes créés ou importés par l'utilisateur.



-  **Mes programmes:** Disponibles sur l'Écran principal OPL. (Voir section 4.1.1)
-  **Bibliothèque de programmes:** (Voir section 4.1.2)
-  **Bibliothèque de phases:** (Voir section 4.1.3)

FRANÇAIS

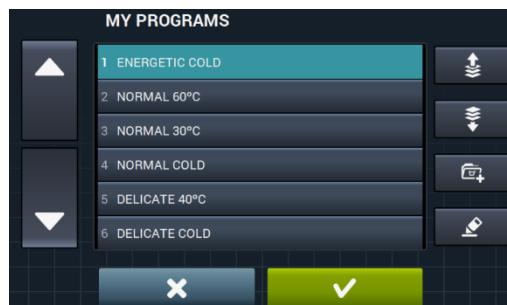

4.1.1 Mes programmes (favoris).

Les programmes dans le dossier « Mes programmes » sont ceux qui sont affichés sur l'écran principal OPL.

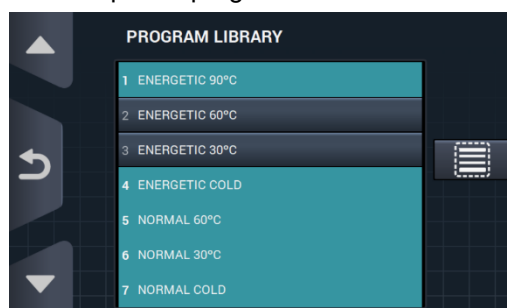

-  **Ajouter/supprimer programmes:** En appuyant dessus, vous êtes redirigé vers la bibliothèque de programmes. Dans cette dernière, les programmes inclus actuellement dans « Mes programmes » sont mis en évidence et les programmes que vous souhaitez ajouter/supprimer de favoris pourront être sélectionnés/désélectionnés un par un.
 -  **Sélectionner/désélectionner tout:** Sélectionne ou désélectionne toute la liste de la bibliothèque de programmes.



-  « flèche vers le haut » et  « flèche vers le bas »: Il est possible de modifier la position de n'importe quel programme inclus dans favoris, en les classant dans l'ordre souhaité.
-  **Bouton éditer:** En appuyant dessus, vous pourrez modifier le programme sélectionné comme si vous étiez en train de l'éditer à partir de la bibliothèque de programmes.



Appuyez sur OK ou annuler pour revenir à mes Programmes.

4.1.2 Bibliothèque de programmes

Les programmes peuvent être ajoutés, copiés, modifiés ou supprimés, de nouveaux programmes peuvent être importés ou exportés vers un port USB.

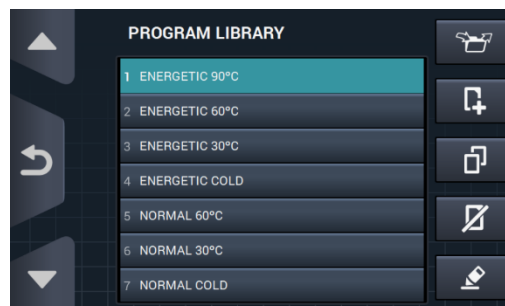

-  **Création de programmes:** création de nouveaux programmes de lavage en utilisant les cycles existants dans la bibliothèque. Lorsque cette touche est utilisée, l'utilisateur est invité à entrer le nom du nouveau programme.

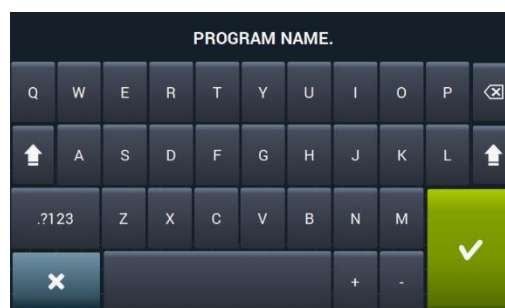

L'écran suivant s'affiche (sans aucun cycle) afin d'y inclure les cycles de la bibliothèque de cycles.

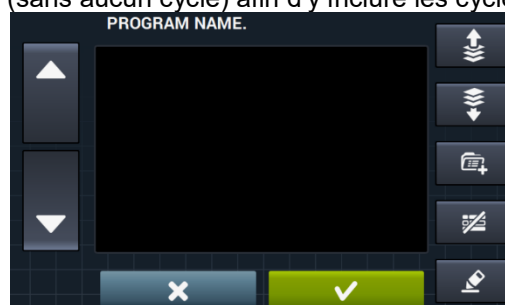







Des cycles peuvent être ajoutés dans la bibliothèque de cycles. Les cycles que vous souhaitez visionner peuvent être filtrés par type de cycle.



Après avoir sélectionné le cycle, les paramètres de la bibliothèque de cycles peuvent être consultés avant de les inclure dans le programme que vous créez.



Chaque programme est un ensemble de paramètres regroupés en cycles qui ne sont liés à aucun des cycles dans la bibliothèque.

-  **Copie programme:** Copie d'un programme trouvé dans la bibliothèque, avec un nouveau nom.
-  **Modification programme:** Modification du nom et des cycles du programme. Il est possible d'ajouter, de modifier, de supprimer ou de modifier l'ordre des cycles existants. Tout comme quand un nouveau programme est créé, quand il est modifié, il est possible d'ajouter/supprimer des cycles de la bibliothèque de cycles.
Lors de la création des programmes, seuls les paramètres du cycle sont consultables. Les cycles déjà dans le programme ne peuvent être modifiés lors de la modification des programmes.
-  **Supprimer programme:** Supprimer les programmes stockés dans la bibliothèque.
-  **Importer/exporter programme:** Permet d'importer/exporter des programmes depuis une clé USB externe.



-  importer programme: Permet d'importer de nouveaux programmes à partir d'un port USB. En accédant à l'USB, seuls les fichiers « .prg » et les dossiers seront visibles.

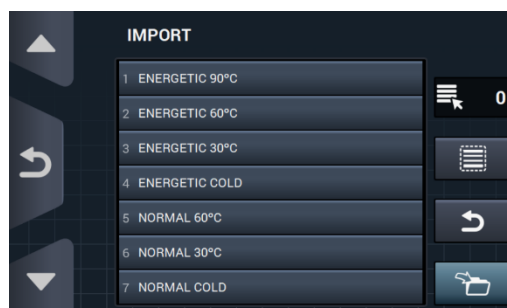

- **Marqueur:** Indique le nombre de programmes sélectionnés.
- **Sélectionner/désélectionner tout:** Sélectionne ou désélectionne tous les programmes du dossier dans lequel vous vous trouvez.
- **Retour:** Permet de quitter le dossier où vous vous trouvez.
Si un programme est importé avec le même nom qu'un programme existant, on vous demandera si vous souhaitez remplacer le programme ou annuler l'opération. Comme il peut y avoir beaucoup de programmes dans cette situation, il y a une zone pour sélectionner « faire la même chose dans tous les cas ».
- **Exporter programme:** permet d'exporter des programmes existants de la bibliothèque vers un port USB.



Il est possible de sélectionner les programmes que vous souhaitez exporter.

- **Sélectionner/désélectionner favoris:** Permet de sélectionner tous les programmes ou les programmes qui sont dans favoris, en indiquant à tout moment le nombre de programmes sélectionnés.

L'ensemble de programmes sélectionné sera enregistré dans un dossier « PROGRAMS » dans le répertoire racine de l'USB et chaque programme sera un fichier.

4.1.3 Bibliothèque de cycles

Le nom de chaque cycle peut être modifié dans la bibliothèque de cycle. Une fois inclus dans un programme, lors de l'affichage de l'information du cycle, le nom affiché pour le cycle sera différent. Ce sera un nom dynamique comprenant le type de phase et un paramètre (température, t/mn).

La bibliothèque de cycles est modifiable et les cycles existants peuvent être créés, modifiés, copiés ou supprimés (Voir section 3.1).



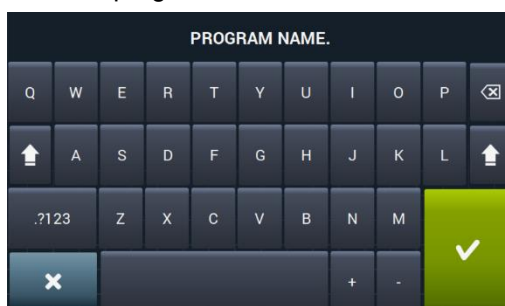

-  **Créer phase:** Création de nouvelles phases de lavage. En appuyant sur ce bouton, vous devrez d'abord saisir le nom du nouveau programme.

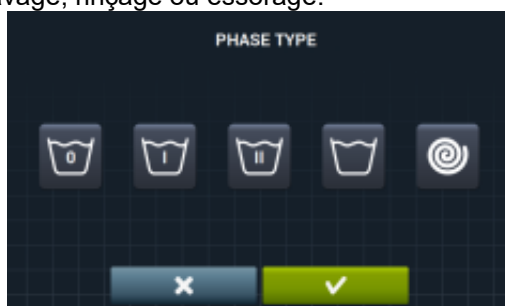

Puis l'écran suivant apparaîtra pour pouvoir sélectionner le type de phase que vous souhaitez créer, trempage, pré-lavage, lavage, rinçage ou essorage.







-  **Copier phase:** Copie d'une phase existante dans la bibliothèque en lui assignant un nouveau nom.
-  **Effacer phase:** Suppression des phases stockées dans la bibliothèque.
-  **Modifier phase:** Modification des paramètres de la phase sélectionnée.

4.2 Configuration Système

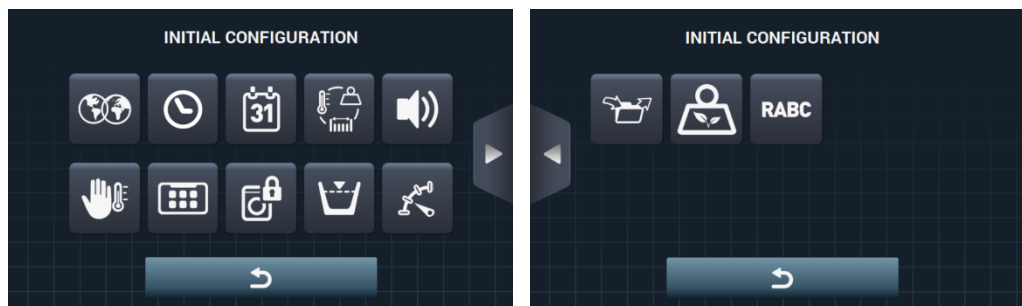
Accès: [écran principal]  ⇒ [menu principal] 

Les sections suivantes peuvent être modifiées dans la configuration du système:



-  **Écran suivant.**
-  **Écran précédent.**
-  **Langue:** Les textes du lave-linge pourront être visualisés dans 34 langues différentes, l'édition de textes ne pourra être réalisée que par des caractères occidentaux.

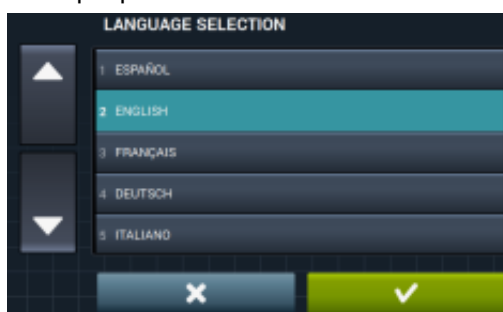

-  **Temps:** Configuration de l'heure actuelle. Le format d'affichage (heure 12/24 heures (par défaut)) peut être sélectionné.

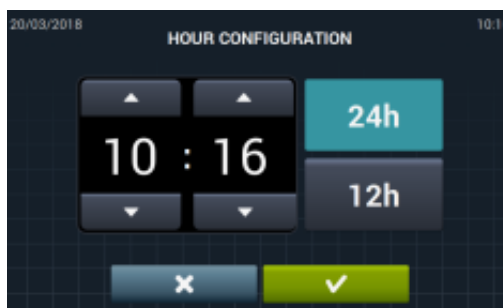

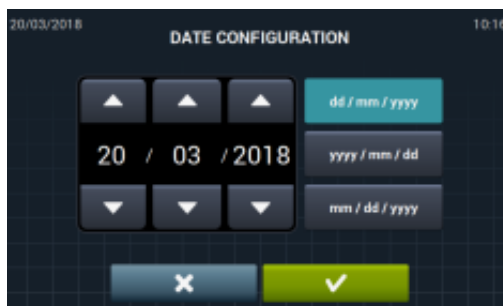

-  **Date:** Configuration de la date actuelle. Le format d'affichage (jj/mm/aaaa (par défaut) / aaaa/mm/jj / mm/jj/aaaa) peuvent être sélectionnés.







- 
Unité de mesure: L'unité de mesure dans laquelle la température (°C (réglage par défaut) ou °F), le poids (Kg (par défaut) ou lb) et la taille (mm (par défaut) ou inch) peut être sélectionnée.



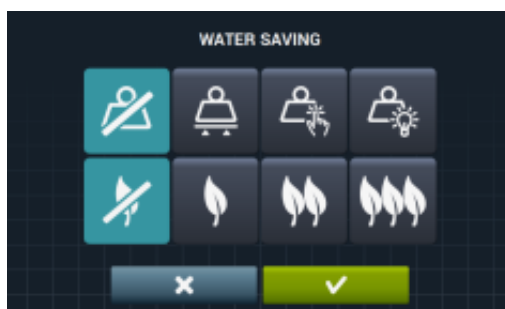



- 
Arrêt thermique: Configuration générale de l'arrêt thermique. Si il est désactivé, l'arrêt thermique n'a pas lieu même si ce paramètre est activé dans le cycle en cours d'exécution. Si, toutefois, il est activé, la configuration de chaque cycle est respectée ainsi que l'action qui en découle. Par défaut, il est actif. Dans les machines sans chauffage (HW), il sera toujours désactivé.

- 
Économie d'eau par poids: Vous pouvez configurer l'économie d'eau souhaitée pour le pesage, en choisissant entre 3 options différentes de pesage et 3 niveaux d'économie. Selon la charge, il y aura une réduction du niveau d'eau et de la dose de détergent.

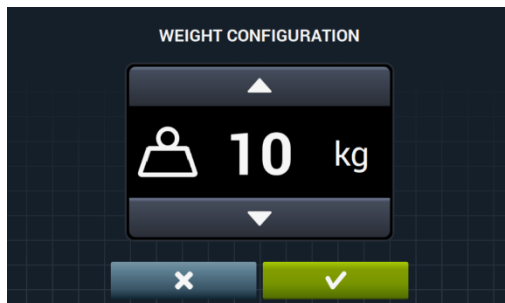

-  Option de pesage désactivé.
-  Option de pesage automatique, elle sera disponible en fonction de la configuration de kits existants.
-  Option de pesage manuel, le poids du linge sera introduit manuellement, en appuyant sur l'icône de poids de l'écran principal (voir section 2.2, point 3).
-  Option de pesage intelligent, cette option estime la charge au début de n'importe quel programme. Le message « LOAD DETECTION » apparaîtra pendant l'exécution. Cette option peut prendre plusieurs minutes. Le temps employé n'est pas compris dans la durée du programme.



-  Option d'économie désactivée.
-  Option d'économie faible.
-  Option d'économie moyenne.



- Option d'économie élevée.



- **Niveaux:** permet la configuration en mm des 5 niveaux configurables. Chaque type de niveau a une plage de valeurs et de configuration par défaut. Ces valeurs dépendent du modèle choisi. (Voir le tableaux des modèle de niveau).



- **Vitesse:** permet la configuration en t/mn de différents types de vitesse existentes au lavage et à l'essorage. Chaque type de vitesses a une valeur de configuration minimale et maximale. (Voir tableau d'équivalences T/MN par modèle).



-  **Configuration import/export:** Il est possible d'importer la configuration de la machine depuis une clé USB ou d'exporter la configuration en cours sur une clé. Lorsque vous appuyez sur ce bouton, une fenêtre intermédiaire s'affiche où vous indiquez si vous souhaitez importer ou exporter.

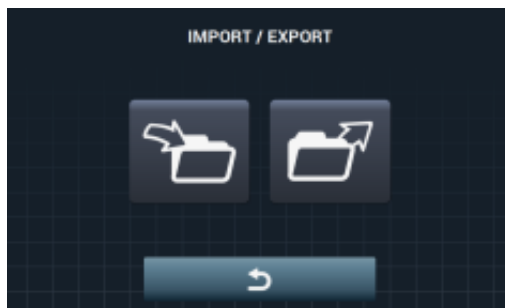

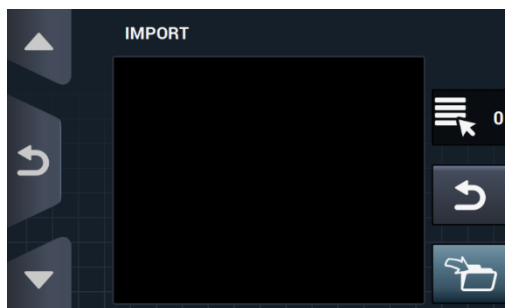

Si IMPORTER est sélectionné, un écran de navigation à travers l'USB sera affiché, seuls les fichiers de configuration (extension .cfg) pourront être sélectionnés.



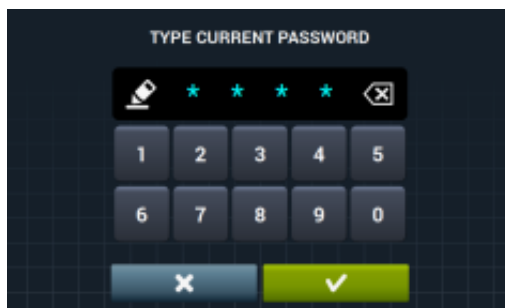

En cas de sélectionner EXPORTER, la configuration actuelle de la machine sera enregistrée dans le répertoire racine de l'USB dans le dossier « CONFIGS ». Chaque fichier de configuration sera désigné sous la forme : CONFIG_Modèle_Date_heure.cfg.

-  **Accès restreint:** permet la configuration de la machine à laver à un accès restreint en créant un mot de passe pour accéder au menu principal. Le paramètre par défaut est désactivé. Le mot de passe requis (1234 par défaut) pour entrer dans le menu principal peut être configuré.



-  **HUD:** La configuration du HUD active/désactive l'affichage des paramètres sur les différents écrans (voir section 4.2.1).



-  **Beep:** Option permettant l'avertisseur d'être désactivé. il est activé par défaut.
-  **RABC/Traçabilité:** Les informations pour chaque lavage sont enregistrées et les informations suivantes sont sauvegardées:
 Au début de chaque cycle : Programme, heure de début, poids (le cas échéant).
 Au cours du programme, toutes les 15 secondes : niveau, température et erreurs (le cas échéant).
 Lorsque vous téléchargez des données, le délai imparti doit être sélectionné (par défaut, la date de début et de fin, la date du jour).
 Les données sont sauvegardées pendant au moins 15 jours.
 À chaque téléchargement, une « RABC » sera créée dans le répertoire racine de l'USB. Chaque fichier rabc sera désigné sous la forme : RABC_Modèle_Date_heure.rabc.



4.2.1 Configuration HUD

Configure les paramètres pour être affichés sur l'écran OFF, l'écran principal et l'écran de fonctionnement, en plus de la configuration de l'arrêt automatique et de l'économie d'énergie.

Accès : [Écran principal]  ⇒ [Menu Principal]  ⇒ [Configurer système] 

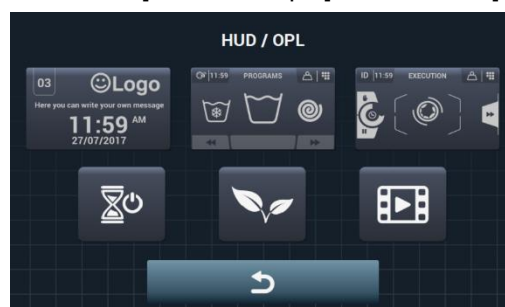

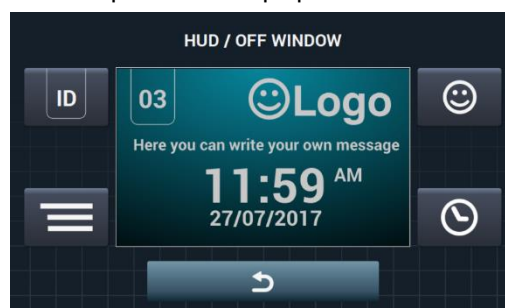

-  **Ecran OFF:** voici les paramètres qui peuvent être configurés:



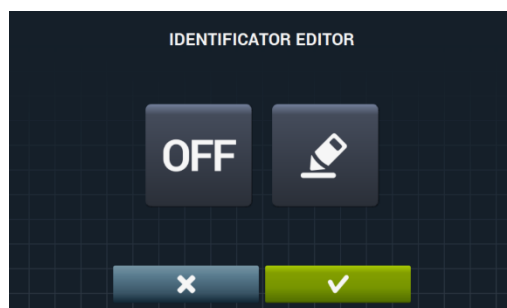

-  **Identification machine:** L'identification de la machine peut être activée/désactivée et le numéro alloué à l'identification peut être modifié (entre 1 et 99). Il est désactivé par défaut. Cet identifiant sera obligatoire en cas d'utilisation de communication à distance.

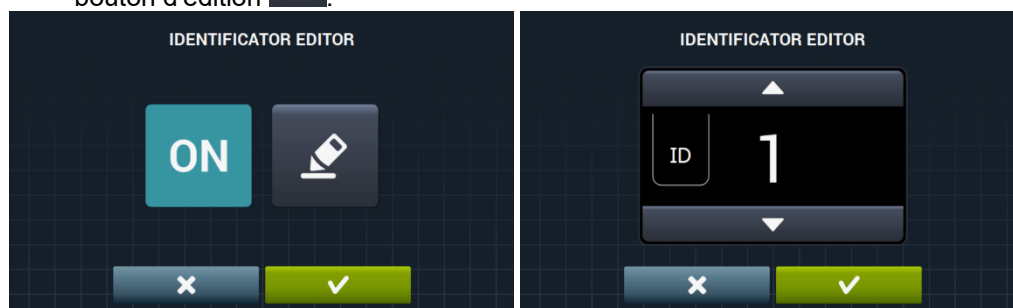

L'identifiant de la machine est activé en appuyant sur le bouton « OFF »  puis sur le bouton d'édition .



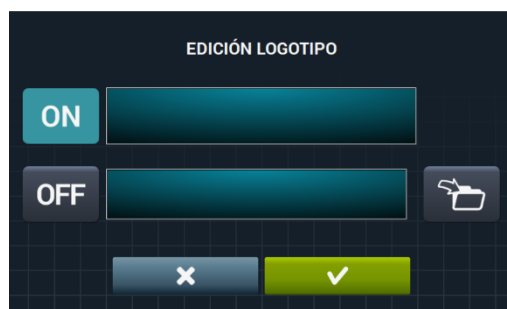

-  **Date:** Option qui peut être activée/désactivée. Elle est activée par défaut.
-  **Logo:** permet à l'utilisateur de choisir d'afficher le logo ou non. fonction activée par défaut.

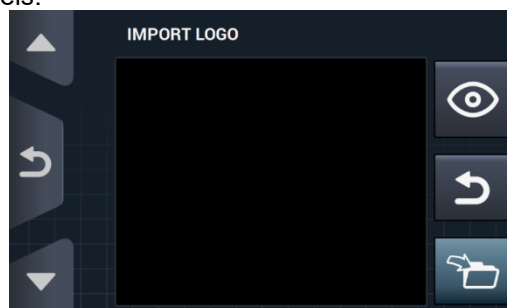

En appuyant sur le bouton importer , vous pouvez importer un logo sur la machine à partir d'une clé USB externe, le fichier du logo doit être au format .png et avoir une résolution de 290 x 80 pixels.





Le bouton prévisualiser , nous permet de vérifier que le logo est vu correctement.

-  **Message laverie:** Message de démarrage qui peut être modifié par l'utilisateur (maximum 40 caractères). Il est désactivé par défaut.



- **Écran principal:** Les paramètres configurables sont énumérés ci-dessous:









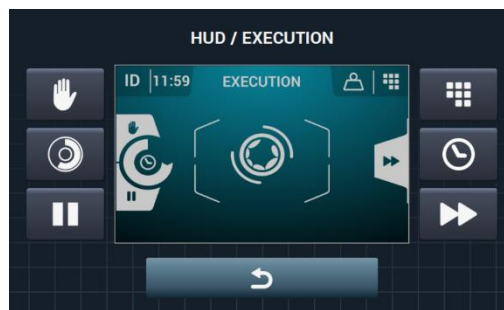

-  **Temps:** Option temps permettant d'être affiché/masqué. activée par défaut.
-  **Poids du linge:** Si cette option est désactivée, l'icône de poids n'est pas affiché. Il est désactivé par défaut.
-  **Programmation instantané:** Si la programmation instantanée est désactivée, les paramètres pour chaque cycle peuvent être consultés mais ne peut pas être modifiés. Elle est activée par défaut.





- **Écran de fonctionnement:** voici les options possibles sur l'écran d'exécution:



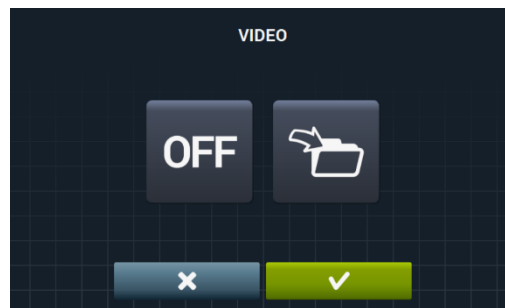

-  **Temps:** Option temps permettant d'être affiché/masqué. Elle est activée par défaut.
-  **Temps restant:** Option pour afficher/cacher le temps total restant et l'indicateur de progression du programme sur l'écran d'exécution. Elle est activée par défaut.
-  **Bouton STOP:** permet le bouton stop d'être caché. Activé par défaut.
-  **Bouton PAUSE:** permet le bouton pause d'être caché. Activé par défaut.
-  **Bouton MENU:** Option qui permet à l'icône du menu de fonctionnement d'être affiché/masqué, par défaut, activé.
-  **Bouton AVANCE:** permet le bouton d'avance et les informations se référant au cycle suivant d'être masqués. activé par défaut.
-  **Arrêt automatique:** Si cette option est activée et que l'écran principal est ouvert, la machine passera à l'écran OFF après 30 minutes d'inactivité. fonction activée par défaut.
-  **Économie d'énergie:** Option qui permet d'économiser de l'énergie en éteignant le rétroéclairage de l'écran 10 minutes après avoir arrêté le lave-linge. Si vous touchez n'importe partie de l'écran, le rétroéclairage s'allumera de nouveau et vous serez dirigé vers l'Écran principal. Par défaut, activé.

-  **Importer fichier vidéo:** Permet de reproduire un fichier vidéo sur l'écran de la machine après 10 minutes d'inactivité. Si « Économie d'énergie » est activée, la reproduction du fichier vidéo est automatiquement désactivée.

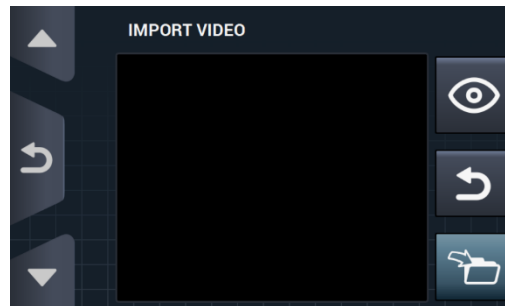

En appuyant sur le bouton importer , vous pouvez importer un fichier vidéo dans la machine à partir d'une clé USB externe, seuls des fichiers vidéo (avi, mov...) pourront être importés, et seul un fichier vidéo pourra être installé sur la machine. La résolution recommandée des vidéos sera, pour les machines ayant un écran de 4,3" de 480x272 pixels, et pour les machines ayant un écran de 7" de 800x480 pixels. Il est déconseillé de dépasser 16 Fps. La taille maximale du fichier ne doit pas dépasser 25 Mo.



Le bouton prévisualiser , nous permet de vérifier la bonne reproduction du fichier vidéo.

5 MAINTENANCE

5.1 Défaits électriques et mécaniques

Avant d'appeler le Centre de Service technique, vérifiez les points suivants:

- Que la machine est alimentée en courant
- L'état des fusibles.
- Que la tension est correcte pour la machine.

Si la machine à laver n'arrive pas au niveau requis d'eau, vérifiez:

- Le robinet d'alimentation d'eau est ouvert.
- Le filtre d'admission d'eau n'est pas bloqué.
- Que la pression de l'eau est comprise entre 2 et 4 kg/cm (28 et 56 psi).

Si la machine vibre trop, vérifiez qu'aucune des vis des panneaux est lâche.

En cas de coupure de courant, assurez-vous que la cuve est vidée et la porte bloquée. Si vous voulez retirer les vêtements de la machine à laver, déverrouillez la porte en tirant vers le bas la courroie située derrière le panneau avant.

5.2 Alarmes

Toutes les alarmes et erreurs sont signalées sur l'écran avec un avertissement sonore. En cas d'erreur, les informations de cycle et le statut sont conservés afin de déterminer exactement où l'erreur s'est produite.

Les alarmes suivantes peuvent s'afficher:

DESCRIPTION	CAUSE ET ACTION
OUVERTURE PORTE	Si la porte est ouverte au début d'un programme, le message « Porte ouverte » s'affiche sur l'écran et le buzzer va vibrer pendant 30 secondes uniquement. Seule l'option « OK » sera possible. Le programme ne sera pas lancé et l'utilisateur pourra réessayer.
EAU DANS LA CUVE	À la fin d'un programme, si le niveau d'eau n'est pas de 0 mm, le message « Eau dans la cuve » s'affiche sur l'écran. Les 2 options « continuer » ou « fin » s'affichent. Si vous appuyez sur « continuer » la machine contrôle à nouveau le niveau à 0 mm. Si c'est le cas, la porte est déverrouillée, sinon l'erreur est signalée à nouveau. Si vous appuyez sur « fin », le programme se termine et la porte se déverrouille.
ABSENCE DE COMMUNICATION ENTRE CARTES	Dans le menu SAT, dans la section de Kits supplémentaires, lors de l'activation d'un kit, si aucune communication n'est détectée entre la carte principale et la carte auxiliaire, cet avertissement sera émis. Tous les kits activés sans communication entre cartes pourront être désactivés, mais pas activés.
RÉSERVOIRS PLEINS (T1/T2/T3)	Cet avertissement sera émis lorsque le réservoir Tx est activé dans une phase de vidange et qu'il détecte que l'entrée « Niveau max. Réservoir x » a été activé. Tx arrêtera de vidanger et passera à une vidange normale D1. Signal acoustique actif pendant 10 secondes. L'avis disparaîtra en appuyant sur OK ou lorsque le laps de temps est écoulé.
RÉSERVOIRS VIDES (T1/T2/T3)	Cet avertissement sera émis lorsque le réservoir Tx est activé dans une phase de remplissage et qu'il détecte que l'entrée « Niveau min. Réservoir x » a été activé. Tx arrêtera de se remplir et passera à être rempli par de l'eau froide normale. Signal acoustique actif pendant 10 secondes. L'avis disparaîtra en appuyant sur OK ou lorsque le laps de temps est écoulé.

ABSENCE DE COMMUNICATION AVEC LE KIT DE PESAGE	Cet avertissement sera émis lors de l'activation du kit de pesage ou lors de la réalisation d'un étalonnage, la carte auxiliaire est connectée et fonctionne correctement, mais ne peut communiquer avec le dispositif de pesage. Le kit ne pourra ni être activé ni étalonné.
ÉTALONNAGE DE PESAGE – ASSURER MACHINE VIDE	Cet avertissement sera émis lors du lancement d'un étalonnage du kit de pesage, afin d'informer l'utilisateur que le lave-linge doit être vide, sans poids dessus, etc., avant de lancer un étalonnage. Aucun. Avertissement purement donné à titre d'information. Bouton de « OK » pour masquer l'avertissement et lancer réellement l'étalonnage.
ÉTALONNAGE DE PESAGE – PROCESSUS EN MARCHE	Cet avertissement sera émis lors de l'exécution de l'étalonnage du dispositif de pesage. Aucun. Avertissement purement donné à titre d'information. Il n'y aura aucun bouton et il sera affiché pendant 5 secondes au cours de l'exécution de l'étalonnage.
ÉTALONNAGE DE PESAGE – MAUVAIS ÉTALONNAGE	Cet avertissement sera émis lorsqu'à la fin du processus d'étalonnage, le dispositif de pesage n'a pas pu être mis à zéro. Aucun. Avertissement purement donné à titre d'information. Bouton de « OK » pour masquer l'avertissement.
ÉTALONNAGE DE PESAGE – BESOIN D'ÉTALONNAGE	Cet avertissement sera émis lorsqu'en appuyant sur « Start » pour exécuter un programme de lavage, le poids mesuré soit inférieur de -3 Kg ou supérieur de 10Kg au poids nominal. Les 2 options seront affichées « Cancel » ou « OK » En appuyant sur « OK », le programme se poursuivra avec le poids nominal. En appuyant sur « Cancel », le programme sera interrompu.
EASY LOAD – LANCER PROCESSUS	Cet avertissement sera émis lorsque vous appuyez sur le bouton Easy Load sur l'écran d'accueil. L'utilisateur sera informé qu'il doit introduire le linge et fermer la porte, la question lui sera posée de savoir s'il souhaite lancer le cycle d'Easy Load. Les 2 options seront affichées « Cancel » ou « OK » En appuyant sur « Cancel », le cycle d'Easy Load sera interrompu et l'écran de sélection sera de nouveau affiché. En appuyant sur « OK », le cycle d'Easy Load sera lancé.
EASY LOAD – CYCLE EN EXÉCUTION	Cet avertissement sera émis lors de l'exécution du cycle d'Easy Load, pour informer l'utilisateur qu'il est en marche. Aucun bouton n'est disponible. Message purement donné à titre d'information, l'utilisateur ne pourra qu'attendre la fin du cycle.
LOAD DETECTION	Cet avertissement sera émis au début du programme de lavage, lorsque l'option « pesage intelligent » est activée. Aucun bouton n'est disponible. Message purement donné à titre d'information. Cette opération peut prendre plusieurs minutes.

Les erreurs suivantes peuvent s'afficher:

ERREUR	DESCRIPTION	CAUSE ET ACTION
E1	COUPURE DE COURANT DÉTECTÉE	Cette erreur sera affichée lors de la récupération de la tension après l'enregistrement d'une coupure de courant lors de l'exécution d'un programme, la machine reprendra le programme automatiquement au même endroit, en affichant un message d'avertissement pendant 30 secondes. Les options « continuer » ou « terminer » seront affichées. Si vous appuyez sur « continuer », le programme reprend à partir de l'étape durant laquelle la coupure s'est produite, mais en démarrant au début de l'étape. Si, au contraire, vous appuyez sur « terminer », le programme s'achèvera, en déverrouillant la porte.
E2	DÉFAUT LORS DU VERROUILLAGE	Cette erreur sera affichée au début d'un programme lorsque la porte ne peut pas être verrouillée ou déverrouillée pendant l'exécution de ce dernier. Le programme s'achèvera et réessaiera de démarrer, assurez-vous que la porte est correctement fermée. Si l'erreur persiste, contactez votre service technique.
E3	DÉFAUT DE VIDANGE/EAU DANS LA CUVE	Cette erreur sera affichée lorsque le lave-linge n'est pas capable de vider l'eau du tambour, les 2 options « continuer » ou « terminer » seront affichées. Assurez-vous que la sortie de vidange n'est pas obstruée. Si la machine est équipée d'une pompe de vidange, nettoyez le filtre.
E4	NIVEAU MAX. D'EAU ATTEINT	Cette erreur sera affichée lorsque le lave-linge détecte un niveau d'eau excessif. Vérifiez que lorsque le lave-linge est au repos, il n'y a pas d'arrivée d'eau. Sinon, appelez le service technique.
E5	DÉFAUT D'ENTRÉE D'EAU	Cette erreur sera affichée lorsque le lave-linge détecte l'absence d'arrivée d'eau. Avant d'appeler le service technique : Assurez-vous que le robinet d'arrêt est ouvert. Vérifiez que la configuration de vidange est correcte (vanne/pompe).
E6	DÉFAUT DE CHAUFFAGE DE L'EAU	Cette erreur sera affichée lorsque le lave-linge ne chauffe pas correctement l'eau. Avant d'appeler le service technique, vérifiez que le chauffage est bien configuré.
E7	TEMPÉRATURE MAXIMALE ATTEINTE	Cette erreur sera affichée en cas de détection de température excessive. Seule l'option « terminer » sera affichée. En appuyant dessus, le programme s'achèvera, si la température est inférieure à 50 °C. Sinon, l'erreur E11 sera affichée : LINGE CHAUD
E8	ERREUR DE MOUVEMENT	Cette erreur sera affichée lorsque le lave-linge ne détecte pas de mouvement. L'avertissement « Fin du programme en cours » sera affiché et après 2 minutes, le bouton OK apparaîtra, et en appuyant dessus le programme s'achèvera.

E9	BALOURD	Cette erreur sera affichée lorsque le lave-linge détecte un balourd. Essayez de charger le linge de façon plus équilibrée.
E10	BALOURD MAX.	Cette erreur sera affichée lorsque le lave-linge détecte un mouvement excessif pendant l'essorage. Si cette erreur apparaît de façon répétitive, appelez le service technique, car il pourrait exister un problème d'installation et/ou d'amortissement.
E11	LINGE CHAUD	Cette erreur sera affichée lorsqu'à la fin d'un programme, la température à l'intérieur de la cuve dépasse 50 °C (122 °F). Patiencez jusqu'à ce que la température devienne inférieure à 50 °C (122 °F), et le programme s'achèvera automatiquement.
E12	ERREUR DÉVERROUILLAGE	Cette erreur sera affichée lorsque le lave-linge n'arrive pas à déverrouiller la porte à la fin du programme. Cette erreur apparaîtra après trois essais de déverrouillage toutes les 20 s. Seule l'option « terminer » sera possible. En appuyant sur cette option, un nouvel essai sera réalisé et en cas d'échec, l'erreur persistera. Ne forcez la porte et appelez le service technique, ils vous conseilleront sur la façon d'ouvrir la porte en toute sécurité.
E23	ERREUR DE PESAGE	Cette erreur sera affichée lorsque le lave-linge détecte une erreur de communication avec le dispositif de pesage. Appelez le service technique. Les deux options, « OK » et « Cancel », seront affichées. En appuyant sur « Cancel », l'exécution du programme sera interrompue, en retournant à la phase de sélection. En appuyant sur « OK », l'exécution du programme se poursuivra avec la valeur de poids nominal de la machine.
E25	ERREUR DE COMMUNICATION COMMANDE - COMMANDE AUX	Cette erreur sera affichée lorsque le lave-linge détecte une erreur de communication avec la carte auxiliaire utilisée dans différents accessoires. Appelez le service technique. Les deux options, « OK » et « Cancel », seront affichées. En appuyant sur « Cancel », l'exécution du programme sera interrompue, en retournant à la phase de sélection. En appuyant sur « OK », l'exécution du programme se poursuivra en ignorant la fonction de l'accessoire correspondant.
E26	ERREUR D'INT. THERMIQUE MOTEUR	Cette erreur sera affichée lorsque le lave-linge détecte une température excessive dans le moteur. Appelez le service technique.
E27	ERREUR NTC HORS PLAGE	Cette erreur sera affichée lorsque le lave-linge détecte une température hors plage. La sonde de température est débranchée ou endommagée. Appelez le service technique. Les 2 options seront affichées « OK » ou « Annuler ». En appuyant sur « OK », le programme se poursuivra en ignorant le chauffage, et en appuyant sur « Annuler », le programme s'achèvera.
E28	ERREUR CAPTEUR DE PRESSION HORS PLAGE	Cette erreur sera affichée lorsque le lave-linge détecte un niveau d'eau hors plage. Le capteur de pression est débranché ou endommagé. Appelez le service technique. Cette erreur ne disposera d'aucun bouton et l'interruption ne pourra se produire qu'en éteignant la machine.

SELF SERVICE V2.0

6	INTRODUCTION.....	35
7	INTERFACE.....	35
7.1	Écran de sélection 1 - Boutons.....	35
7.2	Écran de sélection 2 - Paiement	36
7.3	Impulsions de pièces et « Credit mode ».....	36
7.4	Ecran de fonctionnement.....	37
8	PROGRAMMES.....	38
8.1	Bibliothèque programmes.....	38
9	CONFIGURATION.....	39
9.1	Gestion programmes	39
9.2	Configuration Système.....	39
9.2.1	Configuration avancée	39
9.2.2	programmation HUD	45
9.2.3	Table des devises	47
10	MAINTENANCE.....	49
10.1	Erreurs	49

6 INTRODUCTION

Cette section répertorie les caractéristiques exclusives aux machines de lavage libre-service. Les consignes de sécurité doivent être lues et il est conseillé de lire le reste du manuel afin de bien comprendre comment fonctionne la machine.

7 INTERFACE

7.1 Écran de sélection 1 - Boutons

Lorsque la machine est alimentée, elle ira sur *Écran sélection 1*. Sur cet écran, 4 grands boutons fixes seront disponibles, afin de sélectionner les programmes de lavage.



1. **Identificateur de la machine:** L'étiquette identifiant l'appareil par rapport à la configuration existante sera affichée (en cas d'être activé).
2. **Heure:** L'heure actuelle est affichée au format sélectionné par l'utilisateur.
3. **Nom de programme:** Nom configuré pour le programme sélectionné.
4. **Durée de programme:** Durée, en minutes, estimée pour le programme sélectionné.
5. **Température programme:** Température maximale entre les différentes phases contenues dans le programme.
6. **Prix:** Seulement en mode Coin, en CP et CR, le prix ne sera pas affiché et un voyant led apparaîtra à sa place.
7. **Nombre de programmes:** Les nombres de programmes visualisés et disponibles sont affichés. L'écran indique un maximum de 4 programmes, et le nombre maximum de programmes à afficher sera de 16 (4 écrans à 4 boutons).
8. **Flèches latérales de navigation:** S'il y a plus de 4 programmes dans favoris, les flèches latérales de navigation sont affichées, permettant de montrer l'écran suivant de sélection.

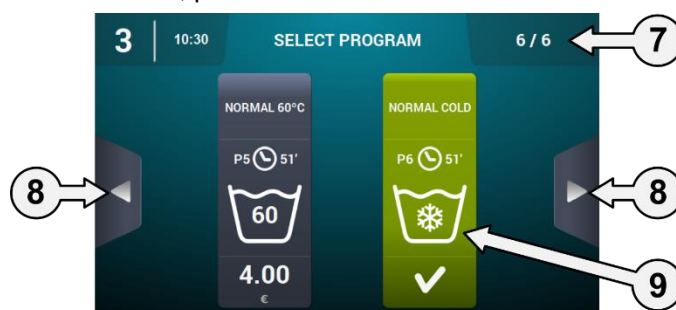

9. **Bouton actif:** Sur ce premier écran, le paiement pourra être réalisé. En parvenant au montant d'un programme, le prix disparaîtra et la couleur du bouton changera indiquant que le programme est activé pour être exécuté.

En appuyer sur le bouton de programme, l'écran « Écran de sélection 2 – Paiement » sera affiché.

À la fin de l'exécution d'un programme, cet écran réapparaîtra.

Ainsi, même si l'écran a été touché ou si des pièces ont été introduites, s'il n'y a aucune activité pendant 15 minutes, cet écran sera de nouveau affiché, et le montant introduit sera réinitialisé.

7.2 Écran de sélection 2 - Paiement

Cet écran contiendra les mêmes informations que l'écran précédent, mais uniquement du programme sélectionné, accompagné d'animation et de texte d'aide. En outre, deux boutons de navigation seront disponibles pour pouvoir changer de programme.

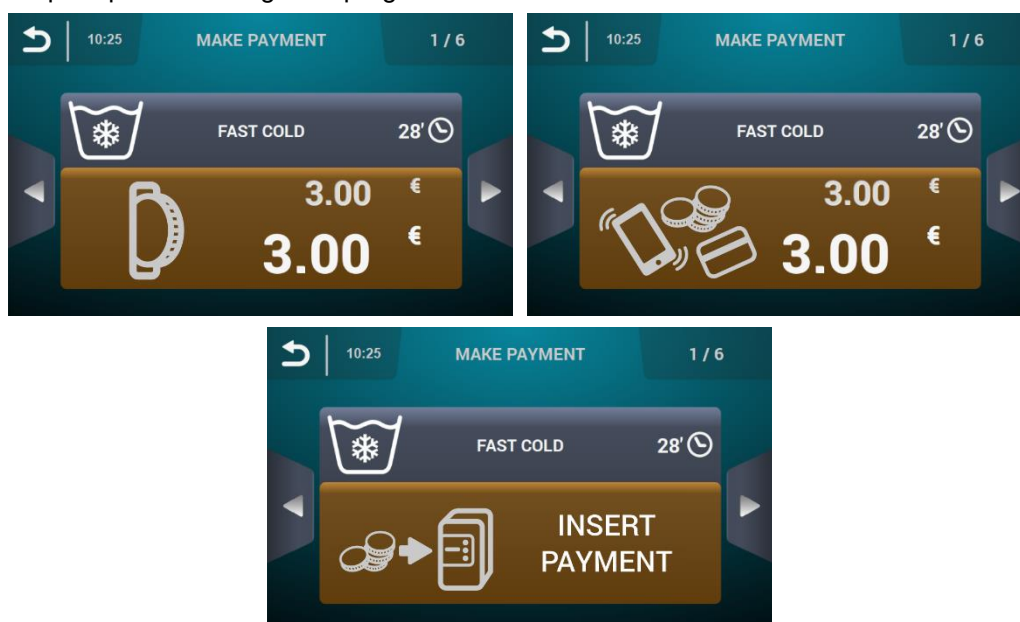

Le bouton sera marron tant que le montant indiqué dans le programme n'est pas introduit.

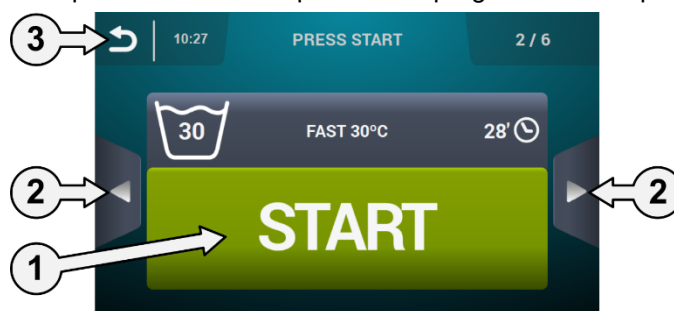

1. **Bouton Démarrage:** En parvenant au montant du programme, le grand bouton de « Démarrage » apparaîtra en vert.
2. **Boutons de navigation:** Nous permettent de changer de programme.
3. **Bouton retour:** En appuyant sur ce bouton, nous retournons à l'écran principal « Sélection 1 - Boutons ».

Après 15 minutes d'inactivité, le montant introduit sera réinitialisé, en perdant l'argent et l'écran « Sélection 1 - Boutons » réapparaîtra.

En appuyant sur le bouton « Start », le programme sélectionné commencera son exécution.

7.3 Impulsions de pièces et « Credit mode »

Aucun programme ne pourra être exécuté avant d'avoir procédé d'abord au paiement correspondant. Pour ce faire, en fonction de la configuration de libre-service existante, l'introduction de pièces (mode COIN) devra être contrôlée ou le signal correspondant reçu en mode CP ou Multipaiement, sur l'entrée « microint. monnayeur » pour permettre l'exécution du programme sélectionné.

En mode libre-service (aussi bien sur l'écran 1 que sur le 2 de sélection, comme lors de l'exécution d'un programme de libre-service), vous pourrez entrer dans « Credit mode ». Si l'entrée « partie supérieure ouverte » est activée dans les modèles industriels ou la clé du monnayeur ou de la CP des modèles professionnels est actionnée, le mot de passe sera requis pour entrer dans « Credit mode ».

Lorsque la machine est en mode « crédit », elle quitte automatiquement le mode libre-service et se comporte comme si elle était en mode normal, affichant les informations définies sur l'écran principal de l'OPL et offrant la possibilité d'effectuer toutes les actions définies sur cet écran. Les programmes sélectionnés pour libre-service et les programmes définis pour le Mode crédit sont affichés.

Aller au menu principal, toutes les options disponibles pour les machines à laver libre-service sont affichées.

Si l'entrée « partie supérieure ouverte » est désactivée dans les modèles industriels ou la clé du monnayeur ou de la CP des modèles professionnels est retirée, le « Credit mode » est quitté automatiquement. Si nous nous trouvons sur l'écran secondaire du menu principal (configuration, entretien...) et si « Credit mode » est quitté, l'intervention se poursuivra comme si nous étions encore dans ce mode jusqu'à l'abandon de l'Écran principal (en sauvegardant les modifications). Une fois sur l'Écran principal, le « Credit mode » est abandonné.

7.4 Ecran de fonctionnement

Lorsque vous appuyez sur START, le programme démarre et l'écran d'exécution s'affiche.

En mode exécution, il est également possible d'entrer dans le « Mode crédit » comme décrit ci-dessus. Si ce mode est entré, la machine quitte le mode libre-service et se comporte comme si elle était en mode OPL, affichant les informations définies sur l'écran d'exécution OPL et offrant la possibilité d'effectuer toutes les actions définies sur cet écran automatiquement.

En mode libre-service, l'option de transférer ou mettre en pause le programme n'existe pas à moins que le "mode crédit" soit entré.

Le bouton STOP pour abandon d'un programme par défaut ne peut être activé, même s'il peut être activé à l'aide du HUD.

Si le bouton STOP est activé, une période de grâce est concédée pendant laquelle un programme peut être interrompu sans perdre le crédit introduit. Si une seconde interruption est réalisée au cours de la période de grâce, le crédit sera perdu.

Une fois la période de grâce écoulée, il faudra appuyer pendant 3 secondes pour interrompre le programme et le crédit sera perdu.

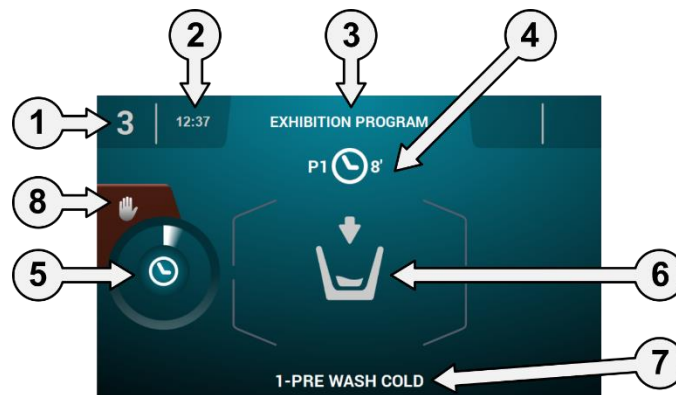

1. **Identification machine:** identification machine.
2. **Temps:** heures et minutes dans le format choisi.
3. **Nom programme:** Nom configuré pour le programme sélectionné.
4. **No et durée du programme:** Position du programme dans la liste des programmes (mes Programmes) et la durée approximative en minutes pour le programme sélectionné.
5. **Indicateur programme:** État d'avancement du programme, temps restant
6. **Statut (dessin):** Dessin montrant le cycle en cours de la machine à laver (remplissage, vidange, lavage, rinçage, essorage ou démêlage).
7. **Cycle en cours:** identification et nom du cycle en cours d'exécution.
8. **Stop:** (désactivé par défaut): bouton pour arrêter et annuler le programme. Un message de confirmation sera demandé.

8 PROGRAMMES

Il existe une bibliothèque de programmes composée de tous les programmes installés par défaut, ainsi que les programmes créés par l'utilisateur.

8.1 Bibliothèque programmes

Ce sont les programmes qui sont trouvés par défaut dans la bibliothèque de programmes :

- P1: lavage à froid rapide
- P2: lavage rapide 30°C (86°F)
- P3: lavage rapide (140°F)
- P4: lavage délicats rapide

P1					
	8	2	2	2	6
	1	3	3	3	
	3	3	3	3	4
	0	0	0	0	
	15;05	15;05	15;05	15;05	
	✓	✓	✓	✓	
	✓	✓	✓	✓	
	✓	✓	✓	✓	
					✓
					✓
D	D2, D3			D4, D5	

P2					
	8	2	2	2	6
	30				
	1	3	3	3	
	3	3	3	3	4
	1	0	0	0	
	15;05	15;05	15;05	15;05	
	✓	✓	✓	✓	
	✓	✓	✓	✓	
	✓	✓	✓	✓	
					✓
					✓
D	D2, D3			D4, D5	

P3					
	8	2	2	2	6
	60				
	1	3	3	3	
	3	3	3	3	4
	1	0	0	0	
	15;05	15;05	15;05	15;05	
	✓	✓	✓	✓	
	✓	✓	✓	✓	
	✓	✓	✓	✓	
					✓
					✓
D	D2, D3			D4, D5	

P4					
	8	2	2	2	6
	2	4	4	4	
	2	2	2	2	3
	0	0	0	0	
	08;06	08;06	08;06	08;06	
	✓	✓	✓	✓	
	✓	✓	✓	✓	
	✓	✓	✓	✓	
					✓
					✓
D	D2, D3			D4, D5	

9 CONFIGURATION

9.1 Gestion programmes

En cas de configuration du lave-linge en mode libre-service, seuls les 16 premiers programmes seront disponibles, le reste le deviendra en entrant dans « Credit mode ».

9.2 Configuration Système







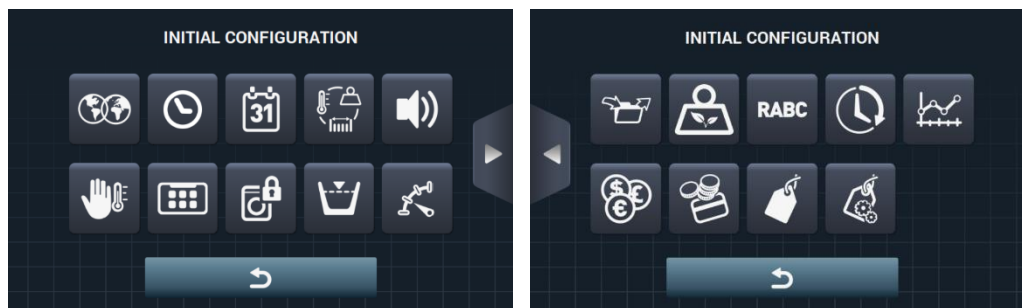

9.2.1 Configuration avancée







Accès : [Écran principal]  ⇒ [Menu Principal] 

Dans la configuration du système, il est possible de configurer les sections suivantes, de la même façon que dans « Credit mode » (voir section 4.2):



FRANÇAIS

-  **Écran suivant.**
-  **Écran précédent.**
-  **Langue:** Les textes du lave-linge pourront être visualisés dans 34 langues différentes, bien que l'édition de textes ne pourra être réalisée que par des caractères occidentaux.
-  **Heure:** Configuration de l'heure du moment. Le format de visualisation pourra être sélectionné (12 heures/24 heures (par défaut)).
-  **Date:** Configuration de la date du moment. Le format de visualisation pourra être sélectionné (dd/mm/yyyy (par défaut) / yyyy/mm/dd / mm/dd/yyyy).
-  **Unités de mesure:** Permet de sélectionner l'unité de la mesure dans laquelle vous souhaitez visualiser la température (°C (par défaut) ou °F), le poids (kg (par défaut) ou lb) et la taille (mm (par défaut) ou po).
-  **Arrêt thermique:** Configuration générale de l'arrêt thermique. S'il est désactivé, l'arrêt thermique ne sera pas réalisé, même si ce paramètre est activé dans la phase en cours. En revanche, s'il est activé, la configuration de chaque phase sera respectée et des mesures seront prises en conséquence. Par défaut, activé.
-  **Économie d'eau lors du pesage:** Vous pouvez configurer l'économie d'eau souhaitée pour le pesage, en choisissant entre 3 options différentes de pesage et 3 niveaux d'économie. En fonction de la charge, la réduction du niveau d'eau et du dosage de détergent sera différente.
-  **Niveaux:** Permet la configuration en mm des 5 niveaux configurables. Chaque type de niveau aura une valeur par défaut et une plage de configuration, valeurs qui dépendront du modèle sélectionné. (Voir tableau de niveaux par modèle).

- 
Vitesse: Permet la configuration en tr/min des différents types de vitesse existants, aussi bien en lavage qu'en essorage. Chaque type de vitesse aura une valeur minimale et maximale de configuration. (Voir tableau d'équivalences tr/min/V par modèle).
- 
Importer / Exporter Configuration: Permet d'importer une configuration de machine à partir d'une clé USB ou d'exporter la configuration actuelle de la machine vers une clé USB. Appuyer sur ce bouton fera apparaître un écran intermédiaire pour sélectionner si l'on souhaite importer ou exporter (comme dans programmes).
- 
Mode crédit: Si la machine à laver est en mode libre-service, le mot de passe pour le Mode crédit (1234 par défaut) peut être configuré. Prenez note du mot de passe en lieu sûr. Si vous le perdez, veuillez appeler le service de support technique.
- 
HUD: En mode libre-service, l'*Écran d'accueil* (le premier et deuxième écran de sélection) et l'*Écran d'exécution* pourront être configurés. (Voir section 9.2.2).
- 
Beep: Option qui permet de désactiver le ronfleur. Par défaut, activé.
- 
RABC/Traçabilité: Les informations de chaque lavage seront enregistrées et sauvegardées (voir section 4.2).
- 
Période de grâce: En appuyant sur ce bouton, un écran intermédiaire apparaîtra sur lequel il sera possible d'activer ou de désactiver la période de grâce, et de modifier sa valeur entre 1 et 99 minutes (activé par défaut et 1 minute).

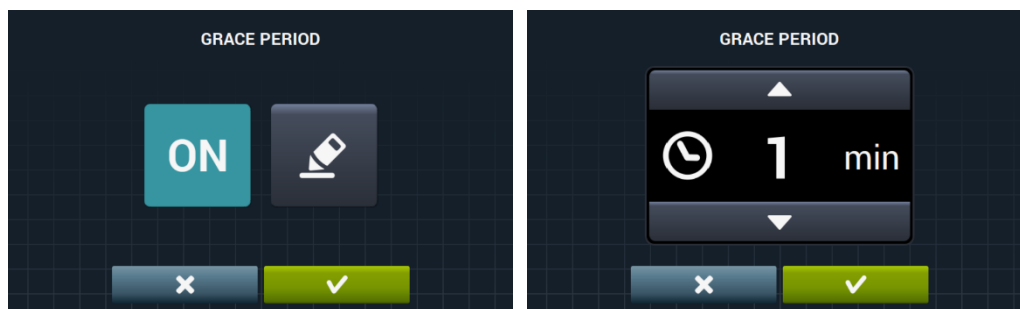

- 
Statistiques de libre-service: Permet l'obtention de données de collecte et du nombre d'exécutions de chacun des programmes favoris. En appuyant sur le bouton de statistiques de libre-service, l'écran suivant est affiché.

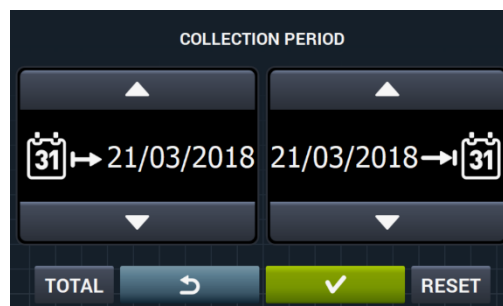

En appuyant sur « TOTAL », les valeurs totales de la machine seront affichées. Si une date est introduite, les statistiques de cette période uniquement seront affichées. En appuyant sur « Reset », toutes les valeurs reviendront à zéro et les statistiques seront réinitialisées.

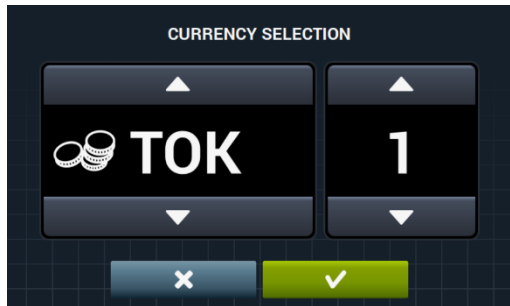

EXECUTIONS AND COLLECTED MONEY		
1 FAST COLD	0	0.00€
2 FAST 30°C	0	0.00€
3 FAST 60°C	0	0.00€
4 FAST DELICATE	0	0.00€
TOTAL	0	0.00€

- 
Devise: Permet de sélectionner le type de devise dans lequel vous souhaitez travailler et de modifier la valeur d'impulsion de celle-ci (voir section 9.2.3). Si vous changez de devise, tous les prix seront réinitialisés, par défaut en jeton.

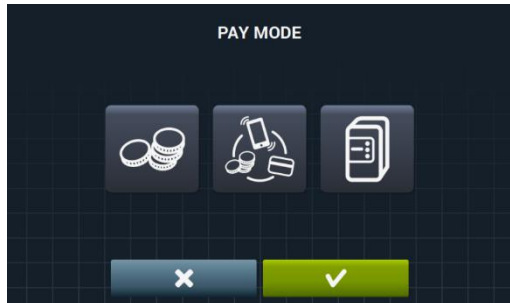

- 
méthode de paiement: Il y a 3 différents modes de fonctionnement en mode libre-service.





- 
COIN: La monnaie et le prix de chaque programme doivent être configurés, utilisant les impulsions du monnayeur pour activer un programme défini.
- 
centrale de paiement: La machine à laver reçoit une impulsion d'une centrale de paiement pour débloquer la machine à laver et autoriser l'exécution d'un. Paramètre par défaut. Les options de monnaie, de prix et de programmation de prix sont désactivées.
- 
Multipaiement: Même comportement que l'option « COIN ».

- 
Prix: Le prix de tous les programmes sélectionnés peuvent être configurés dans « Mes Programmes ». La valeur minimale du programme sera le multiple défini dans la monnaie, et le maximum sera de 100 fois la valeur du multiple. Le paramètre par défaut est la valeur minimale configurable.

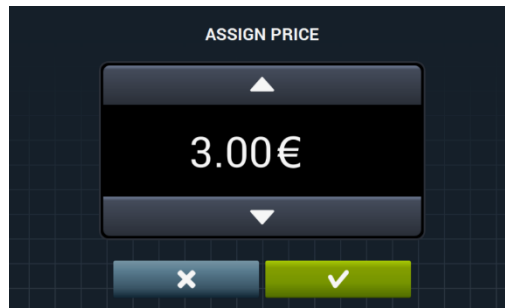

Nous sélectionnons le ou les programme(s) que nous souhaitons modifier et en appuyant sur le bouton  nous sommes redirigés vers la fenêtre pour assigner le nouveau prix.



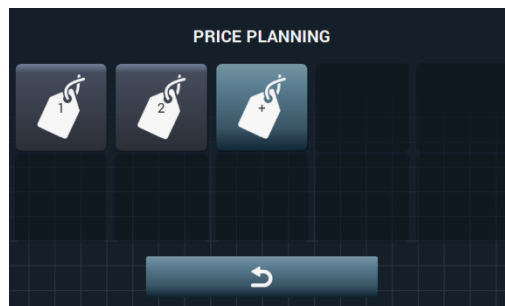

- 
programmation prix: En plus de la configuration de la base de prix, il est possible de définir une programmation de prix. Autrement dit, une période spécifique pour lequel vous souhaitez modifier le prix d'un programme défini. Maximum, 10 programmations simultanées.



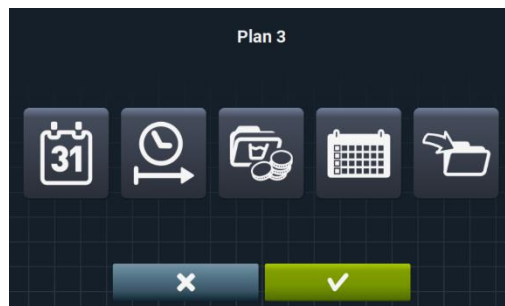

Les prix programmés sont valides pour la tranche horaire configuré. Les prix reviennent aux prix généraux en dehors de la plage horaire configurée. S'il y a un conflit entre différentes programmations, la condition du premier plan s'appliquera. En outre, les programmes ne peuvent être créés à la date en cours.

En appuyant sur le bouton  un nouveau plan est créé. Voici les champs qui devront être remplis lors de la programmation:

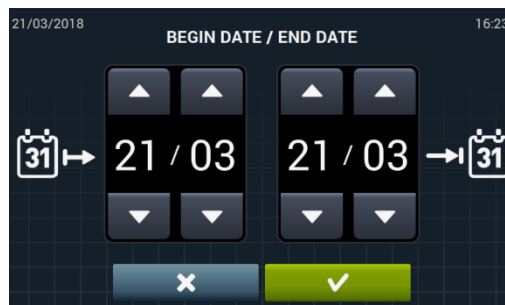

- 
Date: Délai auquel la programmation doit être faite.



-  **Début/fin:** Heure de début et de fin de la programmation.

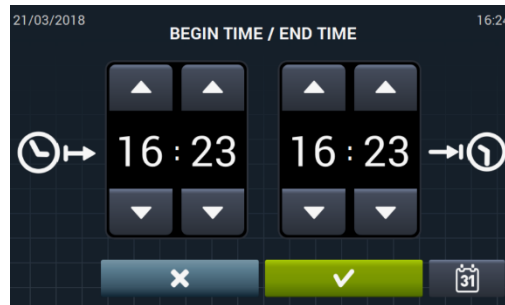

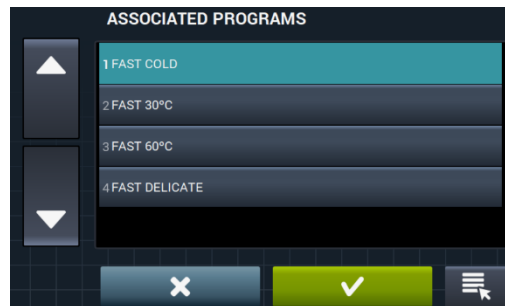

-  **Programme(s) & Prix:** Prix ou remise allouée à chacun des programmes existants dans « mes Programmes ». Un prix forfaitaire peut être attribué ou un escompte appliqué aux programmes sélectionnés.

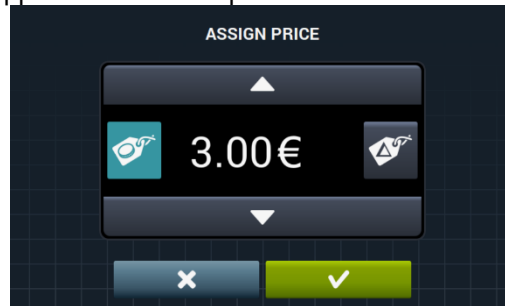

Pour ce faire, nous sélectionnerons le ou les programme(s) auxquels nous souhaitons appliquer la variation de prix et appuierons sur accepter.



-  **Prix fixe:** Le prix fixé sera appliqué à tous les programmes que nous avons sélectionnés.
-  **Réduction:** La réduction fixée sera appliquée à tous les programmes que nous avons sélectionnés.
-  **Calendrier:** Dans la période sélectionnée, jours sur lequel la programmation doit être appliqué.

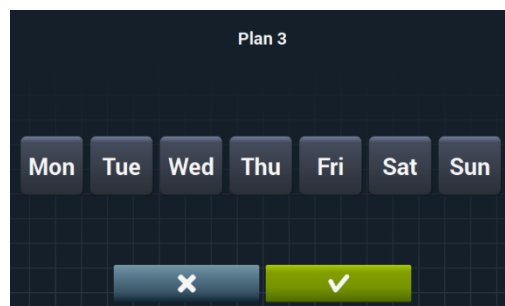

- 
Importer: En plus d'entrer dans les champs un par un, il est également possible d'importer un programme existant depuis une clé USB.

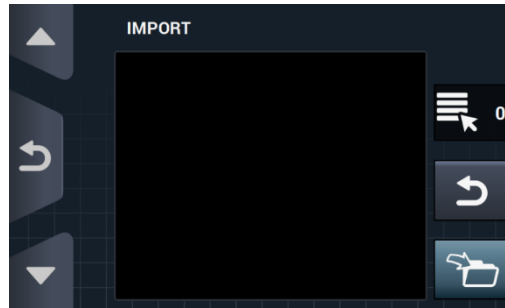

Si l'importation est sélectionnée, le même écran que dans des programmes est affiché pour naviguer à travers le port USB, mais seuls des fichiers de plan (avec extension .plan) peuvent être sélectionnés. Il est seulement possible d'importer un plan lors de l'importation.

Appuyez sur la touche OK et importez le plan, l'affichage retourne à la fenêtre principale de plans tarifaires.

En appuyant sur le bouton de l'un des plans actifs , un résumé des paramètres configurés sera affiché.

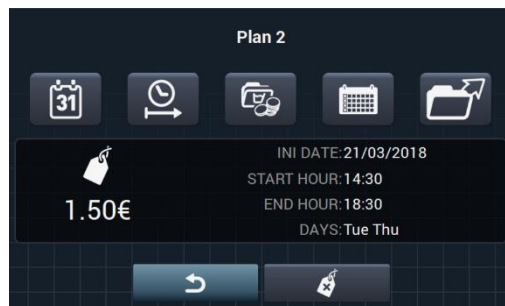

Les paramètres décrits ci-dessus peuvent être modifiés un par un en appuyant sur le bouton correspondant.

En outre, il y a un bouton « Export »  pour l'exportation des plans (dans un fichier avec une extension .plan) dans le répertoire racine de la clé de mémoire USB.

Les fichiers de programmes de prix seront enregistrés dans un dossier appelé « PRICE PLANS » dans le répertoire racine de l'USB.

Chaque fichier de programmes de prix sera désigné sous la forme : PLAN_N°_Date_heure.plan (PLAN_3_20151029_112346.plan par exemple).

Vous pouvez éliminer le plan en appuyant sur le bouton effacer .

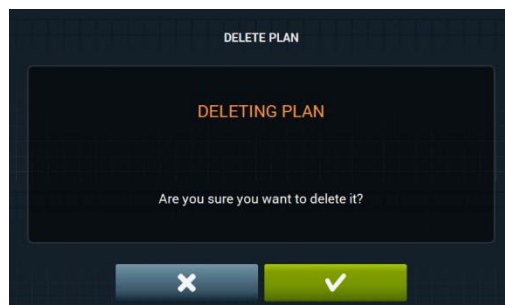

9.2.2 programmation HUD

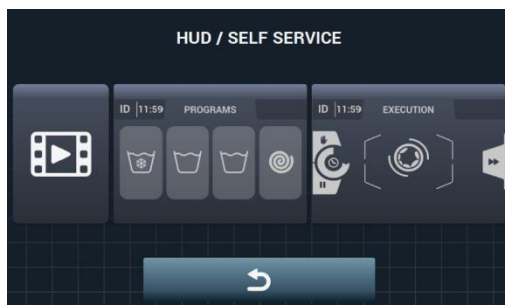

- **Ecran principal:** Ce sera applicable aux deux écrans de sélection de libre-service. Les paramètres suivants peuvent être configurés:



- **ID** **Identifiant de machine:** L'identification de la machine pourra être activée/désactivée et configurée. Par défaut, désactivée.

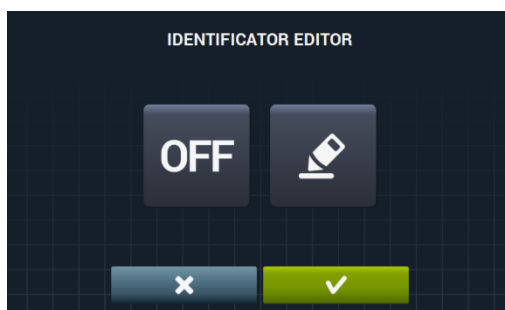

L'identifiant de la machine est activé en appuyant sur le bouton « OFF » **OFF** puis sur le bouton d'édition .

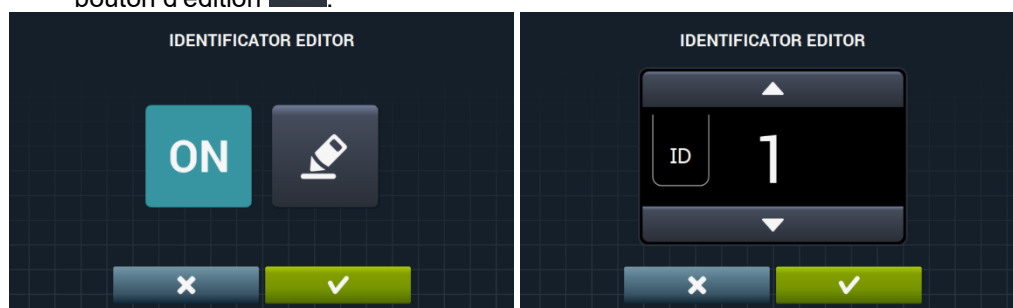





- **Temps:** Afficher/cacher l'heure en cours. activée par défaut.

FRANÇAIS

- 
Écran de fonctionnement: Les options configurables sont énumérées ci-dessous:



- 
Temps: Option temps permettant d'être affiché/masqué. activé par défaut.
- 
Temps restant: Option pour afficher/cacher le temps total restant et l'indicateur de programme. activé par défaut.
- 
Identification machine: L'identification de la machine peut être activée/désactivée. désactivée par défaut.
- 
STOP: permet au bouton stop d'être affiché. désactivé par défaut.
- 
Importer fichier vidéo: Permet de reproduire un fichier vidéo sur l'écran de la machine après 10 minutes d'inactivité. Si « Économie d'énergie » est activée, la reproduction du fichier vidéo est automatiquement désactivée.

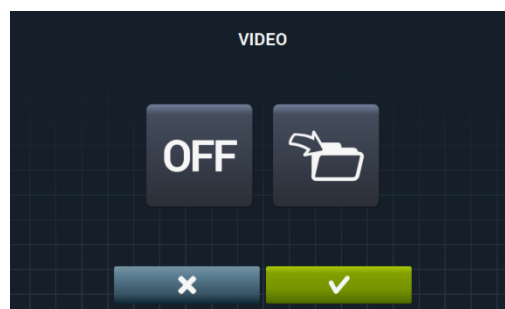

En appuyant sur le bouton importer , vous pouvez importer un fichier vidéo dans la machine à partir d'une clé USB externe, seuls des fichiers vidéo (avi, mov...) pourront être importés, et seul un fichier vidéo pourra être installé sur la machine. La résolution recommandée des vidéos sera, pour les machines ayant un écran de 4,3" de 480x272 pixels, et pour les machines ayant un écran de 7" de 800x480 pixels. Il est déconseillé de dépasser 16 Fps. La taille maximale du fichier ne doit pas dépasser 25 Mo.

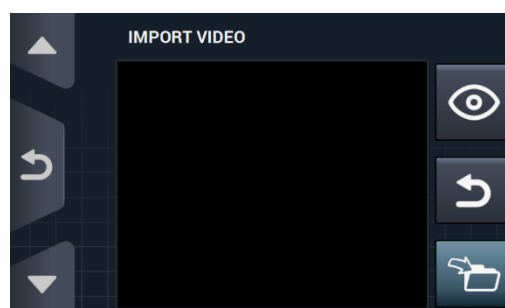

Le bouton prévisualiser , nous permet de vérifier la bonne reproduction du fichier vidéo.

9.2.3 Table des devises

Il s'agit de la table de toutes les monnaies disponibles avec le symbole correspondant et l'impulsion (multiple). Si une valeur d'impulsion différente de celle par défaut est choisie, le monnayeur devra être adapté à cette valeur. L'utilisateur est chargé de le faire. Par défaut, les monnayeurs fournis ont les valeurs suivantes configurées:

PAYS	DEVISES	SYMBOLES	SYMBOLES	Valeur/IMPULSION
Jetons	Jetons	TOK	\$	1
Kuwait	Kuwaiti Dinar	KWD	ك.د.	0,05
Oman	Omani Rial	OMR	ر.ع.	
Azerbaijan	Manat	AZN	m	0,1
Bulgaria	Lev	BGN	лв	
Bahrain	Bahraini Dinar	BHD	ب.د.	
China	Chinese Yuan	CNY	¥	
Malaysia	Malaysian Ringgit	MYR1	RM	
Panama	Panamanian Balboa	PAB	B	
Argentina	Argentine Peso	ARS	\$	
Bermuda	Bermudian Dollar	BMD	BD\$	0,25
Brazil	Real	BRL	R\$	
Canada	Canadian Dollar	CAD	C\$	
Egypt	Egyptian Pound	EGP	م.ج.	
Ethiopia	Ethiopian Birr	ETB	Br	
Guatemala	Quetzal	GTQ	Q	
Cayman Islands	Cayman Islands Dollar	KYD	\$	
Saudi Arabia	Saudi Riyal	SAR	ر.س.	
El Salvador	Salvadoran Colon	SVC	¢	
Turkey	Turkish Lira	TRY	YTL	
United States	US Dollar	USD	\$	
United Arab Emirates	UAE Dirham	AED	د.إ.	
Bolivia	Boliviano	BOB	Bs	
Estonia	Estonian Kroon	EEK	EEK	
Euro-Countries	Euro	EUR	€	
United Kingdom	Pound sterling	GBP	£	
Georgia	Lari	GEL	ლარი	
Ghana	Ghanaian Cedi	GHS	GHS	
Croatia	Croatian Kuna	HRK	kn	
New Zealand	New Zealand Dollar	NZD	\$	
Qatar	Qatari Riyal	QAR	ر.ق.	
Ukraine	Ukrainian Hryvnia	UAH	\$	
Singapore	Singapore Dollar	SGD	S\$	
Malaysia	Malaysian Ringgit	MYR2	RM	

FRANÇAIS

Bosnia and Herzegovina	Convertible Mark	BAM	KM	1
Bangladesh	Bangladeshi Taka	BDT	Tk	
Switzerland	Swiss Franc	CHF	CHF	
Dominican Republic	Dominican Peso	DOP	RD\$	
Hong Kong	Hong Kong Dollar	HKD	HK\$	
Israel	Israeli Shekel	ILS	₪	
India	Indian Rupee	INR	Rs.	
Sri Lanka	Sri Lankan Rupee	LKR	₹	
Morocco	Moroccan Dirham	MAD	د.م.	
Macedonia	Macedonian Denar	MKD	MKD	
Peru	Peruvian Nuevo Sol	PEN	S/.	
Poland	Polish Zloty	PLN	zł	
Russian Federation	Russian Ruble	RUB	руб	
Sweden	Swedish Krona	SEK	kr	
Thailand	Thai Baht	THB	฿	
Tunisia	Tunisian Dinar	TND	د.ت.	
Uruguay	Uruguayan Peso	UYU	\$	
Serbia	Serbian Dinar	RSD	дин.	
South Africa	South African Rand	ZAR	R	
Australia	Australian Dollar	AUD	\$	
Czech Republic	Czech Koruna	CZK	Kč	5
Denmark	Danish Krone	DKK	kr	
Kenya	Kenyan Shilling	KES	KSh	
Mexico	Mexican Peso	MXN	\$	
Norway	Norwegian Krone	NOK	kr	
Romania	Romanian Leu	RON	L	
Philippines	Philippine Peso	PHP	\$	
Algeria	Algerian Dinar	DZD	د.ج.	10
Guyana	Guyanese Dollar	GYD	GY\$	
Hungary	Hungarian Forint	HUF	Ft	
Iceland	Icelandic Krona	ISK	kr	
Kazakhstan	Kazakhstan Tengue	KZT	T	
Taiwan	Taiwanese Dollar	TWD	NT\$	
Chile	Chilean Peso	CLP	\$	
Costa Rica	Costa Rican Colon	CRC	₡	50
Iran	Iranian Rial	IRR		
Paraguay	Paraguayan Guarani	PYG	\$	
French Polynesia	French Pacific Franc	XPF	F	
Colombia	Colombian Peso	COP	\$	100
Indonesia	Indonesian Rupee	IDR	Rp	
Japan	Japanese Yen	JPY	¥	
South Korea	Korean Won	KRW	₩	
Uganda	Ugandan Shilling	UGX	USh	
Venezuela	Venezuelan Bolivar	VEF	Bs.	

10 MAINTENANCE

10.1 Erreurs

Les erreurs avec des actions spécifiques au libre-service sont répertoriées ci-dessous. Les autres actions sont les mêmes que pour les machines OPL.

ERREUR	DESCRIPTION	CAUSE ET ACTION
E6	DEFAUT CHAUFFAGE	Malgré la détection de l'activation de la sortie de chauffage, la température de l'eau n'a pas augmenté pendant 30 minutes. Il est possible d'annuler cette erreur. Dans ce cas, au lieu de déclencher une erreur, la machine continue à s'exécuter comme si la température était intervenue. Un avertissement s'affiche, mais la machine ne s'arrête pas. elle poursuit le programme mais l'avertissement reste jusqu'à la fin du programme et la porte est ouverte.
E9	CHARGE DESEQUILIBREE	A l'essorage final, « le commutateur de balourd » est activé 5 fois. Une erreur n'est pas déclenchée et la machine tourne à basse vitesse. Le programme se termine normalement sans avertissements.

SICHERHEITHINWEISE	2
1 GEBRAUCH	6
1.1 Empfehlungen zum Gebrauch	6
1.2 Gebrauch der Dosiervorrichtung.....	6
1.3 Geräteeigenschaften.....	7
2 SCHNITTSTELLE	7
2.1 OFF-Bildschirm OPL.....	7
2.2 Hauptbildschirm OPL	8
2.3 Ausführungsbildschirm OPL	9
3 PROGRAMME	12
3.1 Phasenparameter	12
3.1.1 Parameter für die Phasen Einweichen, Vorwaschen, Hauptwaschgang oder Klarspülen:	12
3.1.2 Parameter für die Schleuderphasen:	14
3.2 Phasen-Bibliothek.....	15
3.3 Programm-Bibliothek.....	17
4 EINSTELLUNG	18
4.1 Programmverwaltung	19
4.1.1 Meine Programme (Favoritenliste).....	19
4.1.2 Programm-Bibliothek	20
4.1.3 Phasen-Bibliothek.....	23
4.2 System einstellen.....	24
4.2.1 HUD-Einstellung	28
5 WARTUNG	32
5.1 Elektrische und mechanische Fehlerbehebung	32
5.2 Hinweise	32

SICHERHEITHINWEISE

Zur Vermeidung von Stromschlägen und Verletzungen bei Gebrauch des Gerätes beachten Sie bitte die folgenden grundsätzlichen Sicherheitsvorkehrungen:

- **LESEN** Sie bitte alle Anweisungen vor Gebrauch des Gerätes gründlich durch und **BEWAHREN** Sie diese zum späteren Nachschlagen an einem gut zugänglichen Ort auf.
- Waschen Sie **KEINE** Wäsche, die mit Reinigungsbenzin, Lösungsmitteln zur Trockenreinigung, sowie anderen entzündlichen oder explosiven Mitteln vorbehandelt, gewaschen, eingeweicht worden ist oder die Flecken dieser Art aufweist, da hierdurch entzündliche oder explosive Dämpfe entstehen können.
- Geben Sie dem Waschwasser **KEIN** Reinigungsbenzin, Lösungsmittel zur Trockenreinigung oder andere entzündliche Mittel hinzu. Diese Stoffe erzeugen Dämpfe, die sich entzünden oder explodieren können.
- Wenn ein Warmwassersystem länger als zwei Wochen nicht benutzt worden ist, kann es unter bestimmten Umständen zur Erzeugung von Wasserstoffgas kommen. Wasserstoffgas ist explosiv. Wurde das Warmwassersystem während eines längeren Zeitraums nicht benutzt, so öffnen Sie bitte vor Gebrauch der Waschmaschine alle Warmwasserhähne und lassen das Wasser ein paar Minuten lang laufen. Auf diese Art und Weise kann das Wasserstoffgas, das sich angesammelt hat, entweichen. Da das Gas entzündlich ist, sind das Rauchen und offene Flammen verboten.
- Das Gerät kann von Kindern ab 8 Jahren, sowie von Personen mit eingeschränkten körperlichen oder geistigen Fähigkeiten bzw. unerfahrenen und nicht

ordnungsgemäß ausgebildeten Personen bedient werden, wenn diese unter entsprechender Aufsicht arbeiten, die für den sicheren Umgang mit dem Gerät erforderliche Schulung erhalten haben und in der Lage sind, die entsprechenden Gefahren zu erkennen und richtig einzuschätzen. Unbeaufsichtigte Kinder dürfen die vom Bediener durchzuführenden Reinigungs- und Wartungsarbeiten nicht ausführen.

- Kinder dürfen weder auf noch im Gerät spielen. Kinder, die sich in Nähe eines laufenden Gerätes befinden, müssen beaufsichtigt werden. Kinder unter 3 Jahren sind vom Gerät entfernt zu halten, wenn keine ständige Beaufsichtigung gewährleistet werden kann.
- Vor dem Entsorgen oder der Außerdienstnahme des Gerätes nehmen Sie bitte die Tür ab.
- **VERSUCHEN SIE NICHT, DIE TÜR bei laufender Trommel ZU ÖFFNEN.**
- Das Gerät darf **NICHT** im Freien installiert oder gelagert werden.
- **KEINE** Gewalt bei der Bedienung der Steuervorrichtungen anwenden.
- Ausschließlich die zusammen mit dem Gerät ausgelieferten Schläuche verwenden (auf keinen Fall gebrauchte Schläuche verwenden).
- Führen Sie eigenständig weder Reparaturen noch den Austausch von Teilen am Gerät durch und versuchen Sie nicht, Wartungstätigkeiten selbständig durchzuführen, es sei denn, dass in der Bedienungsanleitung ausdrücklich darauf verwiesen wird. Vergewissern Sie sich stets, dass Sie die Anweisungen richtig verstanden haben und dass Sie

über die erforderlichen Voraussetzungen zur Durchführung derselben verfügen.

- Entfernen Sie **KEINE** Sicherheitsvorrichtungen und ändern Sie keines der zur Waschmaschine gehörenden Elemente. Das Installieren von **NICHT ZUM GERÄT GEHÖRENDEN** Elementen im Geräteinneren ist untersagt.
- Die Nichteinhaltung der in den Handbüchern beschriebenen Anweisungen kann zu Personenschäden führen. Leider ist es nicht möglich, auf alle Umstände und Situationen mit Hilfe von Gefahrenschildern und Hinweisen aufmerksam zu machen. Gesunder Menschenverstand, entsprechende Sicherheitsvorkehrungen und Vorsicht werden daher bei allen Personen, die das Gerät transportieren, installieren oder warten, vorausgesetzt.
- Das Gerät **NICHT BENUTZEN**, wenn nicht alle Abdeckungen und Schutzvorrichtungen ordnungsgemäß angebracht und befestigt sind.
- Der Fachhändler (Verkäufer) **MUSS** den Anwender während der Inbetriebnahme angemessen mit dem Gerät vertraut machen und unterweisen.
- Geben Sie in die Fächer der Waschmittelschublade die vom jeweiligen Hersteller empfohlenen Mengen an Waschmittel, Weichspüler und Bleichmittel. Beachten Sie die Hinweise des Herstellers zur der Behandlung des jeweiligen Stoffs.
- Reinigen Sie die Fächer der Waschmittelschublade täglich von Waschmittel- und Flüssigkeitsresten. Zur Reinigung sollten lediglich Wasser und Seife, auf keinen

Fall aber scheuernde Reinigungsmittel verwendet werden.

- Reinigen Sie die Filter für die Wassereinlässe und die äußeren Dosierleitungen einmal pro Monat.
- Reinigen Sie das Geräteäußere auf keinen Fall mit Druckwasser, da die Funktionsbauteile der Waschmaschine beschädigt werden können.
- Soll die Waschmaschine während eines längeren Zeitraums nicht benutzt werden, so ist ein dünner Film Vaselineöl auf alle Flächen aus Edelstahl aufzutragen.
- Werkseitig wird empfohlen, das Gerät einmal jährlich gründlich zu überprüfen.

1 GEBRAUCH

1.1 Empfehlungen zum Gebrauch

Diese Waschmaschine ist zum Waschen bzw. Behandeln von Textilien im Allgemeinen entworfen und konzipiert worden. Jede Verwendung zu anderen Zwecken als den angegebenen wird als unzulässig und gefährlich angesehen.

Werkseitig wird empfohlen, das Gerät mit der Nennlast zu füllen und erheblich geringere oder größere Trommelfüllungen zu vermeiden.

Wir raten davon ab, in Säcke gefüllte Wäsche zu waschen. Füllen Sie die Waschmaschine in diesem Fall bis zur Nennlast, um eventuelle Ungleichgewichte der Trommelfüllung zu vermeiden.





Es wird davon abgeraten, Planen oder wasserfeste Kleidung, Feudel, Auslegware oder Teppiche zu schleudern.

Die Gerätetür darf erst geöffnet werden, wenn die Trommel zum Stillstand gekommen ist. Aus Sicherheitsgründen muss nach Programmende einige Sekunden gewartet werden, bevor die Tür entriegelt werden kann.

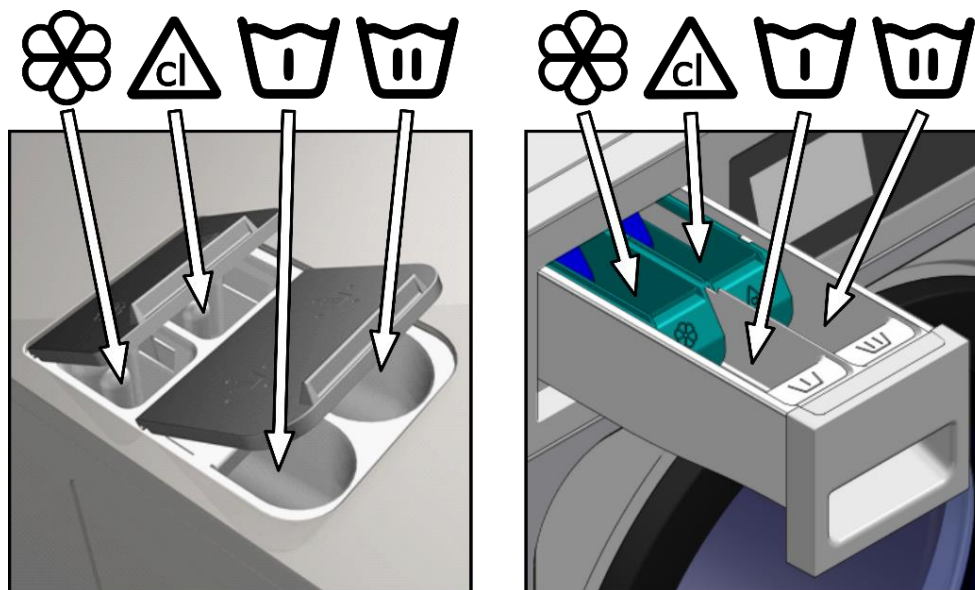
1.2 Gebrauch der Dosiervorrichtung

Die Produkte zum Waschen in die entsprechenden Fächer einfüllen und den Deckel der Dosiervorrichtung schließen.



-  Waschmittelpulver für die Vorwäsche
-  Waschmittel für die Hauptwäsche
-  Flüssiger Weichspüler
-  Flüssiges Bleichmittel (Lauge)

1.3 Geräteeigenschaften

Die Steuerung des Gerätes erfolgt über einen programmierbaren Mikroprozessor, der individuell an den jeweiligen Kundenbedarf angepasst werden kann.

Das Gerät ist mit einer intelligenten Steuerung zur Einstellung der Temperatur ausgestattet. Bei zur Verfügung stehendem Warmwasser sollte diese Steuerung eingeschaltet werden. Die Waschmaschine steuert dann die verschiedenen Wassereinlässe und hält so die programmierte Temperatur konstant.

Die intelligente Steuerung ist ebenfalls bei der Steuerung des Schleudervorgangs behilflich. Die Waschmaschine gleicht dann das beim Füllen der Trommel erzeugte Ungleichgewicht aus und passt die Umdrehungszahl entsprechend an, so dass ein optimales geräuscharmes Schleudern erreicht wird, das die Lebensdauer der Verschleißelemente verlängert und so Ermüdungserscheinungen an den mechanischen Bauteilen vorbeugt.

2 SCHNITTSTELLE

Alle Waschmaschinen sind mit einem Tastbildschirm ausgerüstet, auf dem alle geräterelevanten Informationen angezeigt werden und gleichzeitig die Auswahl aller Steuervorrichtungen ermöglicht wird.

Sobald das Gerät mit Spannung versorgt wird, erscheint der *OFF-Bildschirm*. Die ON-/ OFF-Taste führt zum *Hauptbildschirm*, von dem aus ein Programm gestartet werden oder der Zugang zum Hauptmenü erfolgen kann. Nach Drücken von START erfolgt der Zugang zum *Ausführungsbildschirm*, auf dem alle geräterelevanten Informationen angezeigt werden.

Nach Drücken von ON/OFF erfolgt die Rückkehr zum *OFF-Bildschirm* von der jeweiligen Bildschirmmaske aus.

Die auf den verschiedenen Bildschirmmasken gezeigten Informationen können über das Menü HUD aus- bzw. eingeblendet werden (siehe Abschnitt 4.2.1)

2.1 OFF-Bildschirm OPL

Diese Bildschirmmaske erscheint bei ausgeschalteter Waschmaschine. Die vom Anwender eingestellten Parameter werden angezeigt.

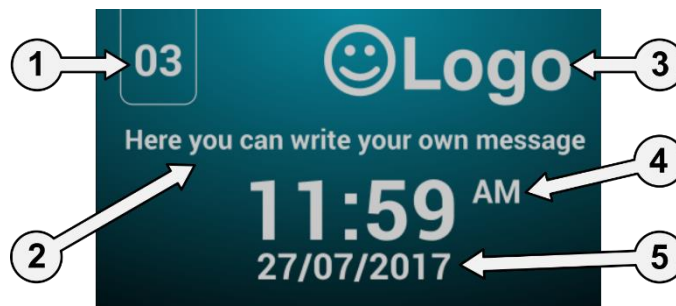

1. **Gerätekenzeichner:** Angabe zur Kennzeichnung des Gerätes (falls die entsprechende Funktion aktiviert ist).
2. **Meldung Wäscherei:** Vom Anwender eingestellte Meldung (falls die entsprechende Funktion aktiviert ist).
3. **Logo:** Das eingestellte Logo wird angezeigt (falls die entsprechende Funktion aktiviert ist)
4. **Uhrzeit:** Stunden und Minuten im ausgewählten Format.
5. **Datum:** Datum im ausgewählten Format (wenn zuvor die entsprechende Auswahl im HUD-Menü erfolgt ist).

Ist die Option „Energieeinsparung“ eingeschaltet, so wird erlischt die Hintergrundbeleuchtung 10 Minuten nach Ausschalten der Waschmaschine. Die Hintergrundbeleuchtung geht erneut an, sobald der Bildschirm berührt wird.

2.2 Hauptbildschirm OPL

Der *Hauptbildschirm* der Waschmaschine sieht wie folgt aus und dient zur Festlegung aller verfügbaren Optionen. Einige dieser Optionen können über das HUD-Menü ausgeblendet werden.



1. **Gerätekennzeichner:** Angabe zur Kennzeichnung des Gerätes.
2. **Uhrzeit:** Stunden und Minuten im ausgewählten Format.
3. **Wäschegewicht:** Hier werden das Gewicht der eingegebenen Wäsche (der entsprechende Bausatz muss verfügbar sein) oder die Nennlast des ausgewählten Modells (falls der Bausatz nicht freigeschaltet ist) angezeigt. Das Gewicht der eingegebenen Trommelfüllung kann hier bearbeitet werden. Möglichkeit zum Ein- bzw. Ausblenden im HUD-Menü. Nach Beendigung oder Abbruch des Programms wird die Nennlast der Maschine erneut ausgewählt.
4.  **Hauptmenü:** Hier erfolgt der Zugang zum Hauptmenü der Waschmaschine zur Steuerung der verschiedenen Geräteparameter.
5. **Programmname:** Für das ausgewählte Programm eingestellter Name.
6. **Programmtemperatur:** Höchsttemperatur zwischen den verschiedenen zum Programm gehörenden Phasen.
7. **Programmnummer und -dauer:** Stellung des Programms in der Programmliste (Meine Programme) und die ungefähre Dauer des ausgewählten Programms in Minuten.
8. **Programm vor bzw. zurück:** Hier kann in der Liste der ausgewählten Programme vor- bzw. zurück gesprungen werden. Das Vor- bzw. Zurückspringen in der Programmliste kann nicht nur mit den Tasten sondern auch durch direktes Drücken der zum jeweiligen Programm gehörenden Informationen erfolgen (diese stehen genau über der Taste).
9. **Start:** Mit dieser Taste wird die Ausführung des ausgewählten Programms ab der angegebenen Phase gestartet.
10. **Programmphasen:** Nach Drücken des dem ausgewählten Programm entsprechenden Symbols werden die verschiedenen zum Programm gehörenden Phasen angezeigt, so dass die Phase ausgewählt werden kann, mit der das Programm beginnen soll.
 Asimismo, existirá la posibilidad de realizar una programación instantánea, esto es, cambiar los
 Zusätzlich besteht die Möglichkeit, eine sofortige Programmierung vorzunehmen. Dabei werden die zu einer bestimmten Phase gehörenden Parameter (Dauer, Temperatur, Wasserstand und Dosierung) für die gerade in Ausführung befindliche Phase geändert. Diese Werte werden allerdings nicht für spätere Ausführungen gespeichert.

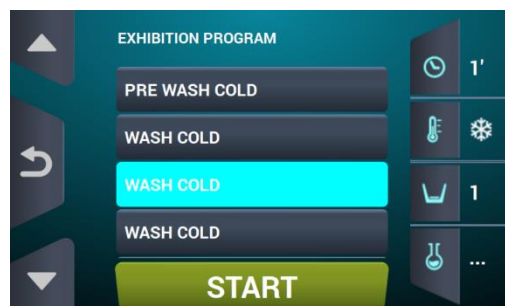

2.3 Ausführungsbildschirm OPL

Das Programm startet nach Drücken der START-Taste. Auf dem Bildschirm werden alle programmrelevanten Informationen angezeigt. Einige dieser Optionen können über das HUD-Menü ausgeblendet werden.

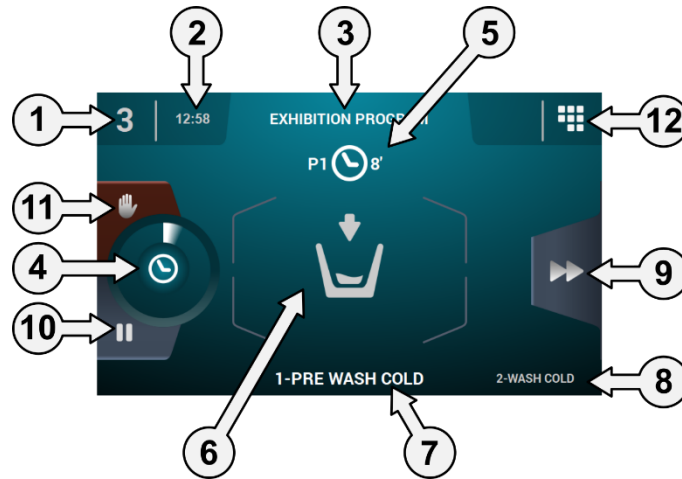



- Gerätekennzeichner:** Angabe zur Kennzeichnung des Gerätes.
- Uhrzeit:** Stunden und Minuten im ausgewählten Format.
- In Ausführung befindliches Programm:** Programmname, Programmnummer und Programmdauer.
- Fortschrittsanzeige für das Programm:** Programmfortschritt, Beziehung zwischen Gesamtdauer und Restzeit des Programms.
- Programmnummer und -dauer:** Stellung des Programms in der Programmliste (Meine Programme) und die ungefähre Dauer des ausgewählten Programms in Minuten.
- Zustand (Symbol):** Symbol zur Anzeige der gerade in Ausführung befindlichen Phase der Waschmaschine (Füllvorgang, Entleeren, Waschen, Klarspülen, Schleudern oder Auflockern).

	Tür wird geöffnet		Neigung Vorderseite
	Aufheizen		Neigung Rückseite
	Auflockerung		Schleudern
	Abkühlen		Vorgang wird beendet
	Füllen		Waschen
	Gerät wird gestoppt		Programmierte Unterbrechung
	Wäsche entnehmen		Entleeren

- In Ausführung befindliche Phase:** Kennzeichner und Name der in Ausführung befindlichen Programmphase.
- Nächste Phase:** Kennzeichner, Name und Symbol der nächsten Programmphase (handelt es sich um die letzte Phase, so erfolgt keine Anzeige).
- Phase vor:** Diese Taste ermöglicht das Vorspringen zur nächsten Programmphase (handelt es sich um die letzte Phase, so erfolgt keine Anzeige). Das Vor- bzw. Zurückspringen der Programmphase kann nicht nur mit der Taste sondern auch durch direktes Drücken der folgenden Phase erfolgen (diese steht genau über der Taste).

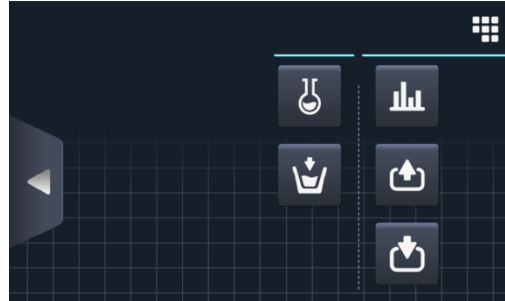
10. **Pause:** Diese Taste ermöglicht es, das in Ausführung befindliche Programm zu unterbrechen. Wird das Programm unterbrochen, so wechselt das Symbol für Pause auf „Play“ und das Programm kann an der Stelle fortgesetzt werden, an der es zuvor unterbrochen worden ist.
11. **Stop:** Taste zum Abbrechen des Programms. In diesem Fall fordert das System eine Bestätigung an.
12.  **Ausführungsmenü:** Zugang zu den derzeit benutzten Parametern.



-  **Eingänge:** Der Zustand der verschiedenen Eingänge wird angezeigt. Die an ALLEN Geräten verfügbaren Eingänge werden IMMER angezeigt. Die Eingänge, die einer bestimmten Funktion vorbehalten sind (zum Beispiel, Selbstbedienung, Sanitär, zusätzliche Dosiervorrichtungen, Behälter (T1, T2, T3), Kippen, usw.), sind nur bei entsprechend eingeschalteter Funktion verfügbar.

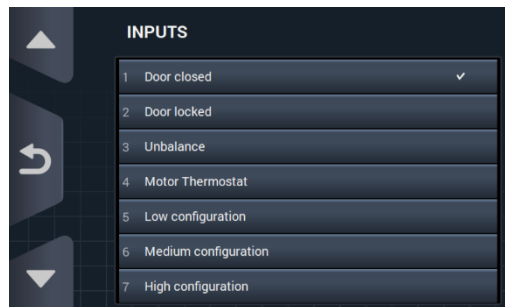

-  **Ausgänge:** Der Zustand der verschiedenen Ausgänge wird angezeigt. Die an ALLEN Geräten verfügbaren Ausgänge werden IMMER angezeigt. Die Ausgänge, die einer bestimmten Funktion vorbehalten sind (zum Beispiel, Selbstbedienung, Sanitär, zusätzliche Dosiervorrichtungen, Behälter (T1, T2, T3), Kippen, usw.), sind nur bei entsprechend eingeschalteter Funktion verfügbar.

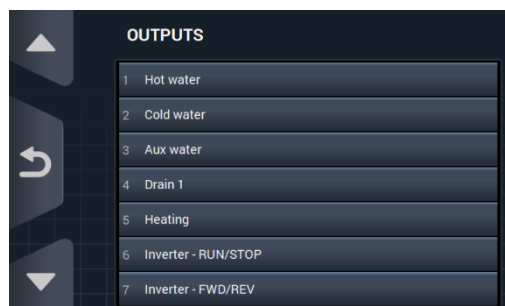

- 
Sollwerte/Werte: Anzeige der Soll- und Istwerte der in Ausführung befindlichen Phase (Temperatur, Wasserstand, Restzeit). Nach Drücken der Tasten in der rechten Spalte können die Sollwerte bearbeitet werden. Die entsprechenden Änderungen wirken sich ausschließlich auf die laufende Ausführung aus.

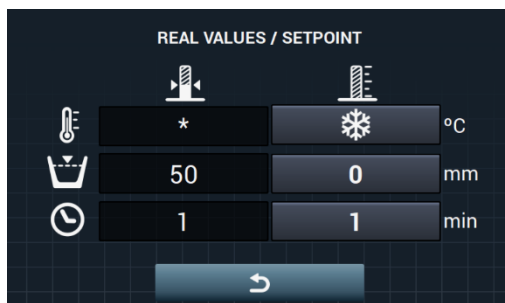

- 
Manuelle Dosierung: Hier wird der Zustand der jeweiligen Dosiervorrichtung (ON/OFF) angezeigt und die gewünschte Dosierung kann ein- bzw. ausgeschaltet werden. Die verfügbaren Optionen werden durch die vorhandenen Bausätze bestimmt. Bei Verlassen des Bildschirms für die Dosierung werden alle Dosiervorrichtungen ausgeschaltet.



- 
Wasserzufuhr von Hand: Hier wird der Zustand der jeweiligen Wasserzufuhr (ON/OFF) angezeigt und die gewünschte Wasserzufuhr kann ein- bzw. ausgeschaltet werden. Die durch den Einfüllvorgang eingeschaltete Wasserzufuhr kann nicht ausgeschaltet werden. Bei Verlassen des Bildschirms für die Wasserzufuhr werden alle von Hand eingeschalteten Wasserzufuhren ausgeschaltet.

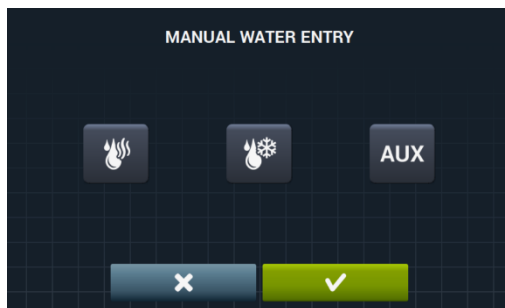

3 PROGRAMME

Das System verfügt über eine Bibliothek mit allen defaultmäßig vorhandenen Programmen, sowie den vom Anwender angelegten Programmen.





Im Folgenden werden die verschiedenen in der Bibliothek enthaltenen Parameter und Standardprogramme erläutert und im Anschluss daran folgt die Darstellung der Verwaltung und Steuerung für die verschiedenen Waschprogramme (siehe Abschnitt 4.1).





3.1 Phasenparameter

Jedes Programm besteht aus einer Reihe an Phasen, die sich wiederum aus einem Satz einstellbarer Parameter zusammensetzen.

3.1.1 Parameter für die Phasen Einweichen, Vorwaschen, Hauptwaschgang oder Klarspülen:



- **Phasenname:** Name zur genauen Kennzeichnung der jeweiligen Programmphase. Hierbei handelt es sich allerdings nicht um den auf dem *Ausführungsbildschirm* angezeigten Text, sondern um den Text zur genauen Kennzeichnung einer bestimmten, bereits angelegten Programmphase.
-  **Dauer:** Wertangabe der Phasendauer in Minuten. Der einstellbare Bereich beträgt von 1 bis 99.
-  **Temperatur:** Temperatur der in Ausführung befindlichen Programmphase in °C oder °F. Der einstellbare Bereich beträgt von 20°C (68°F) bis 90°C (194°F).
-  **Wasserstand:** Wasserstand, mit dem die jeweilige Programmphase ausgeführt werden soll. Einstellbare Bereiche (siehe Abschnitt 4.2). Es sind 5 verschiedene Wasserstände verfügbar: Mindeststand (1), niedriger Wasserstand (2), mittlerer Wasserstand (3), hoher Wasserstand (4) und Höchststand (5).
-  **Geschwindigkeit:** Ausführungsgeschwindigkeit der jeweiligen Programmphase. Einstellbare Bereiche (siehe Abschnitt 4.2). Es können 4 verschiedene Geschwindigkeiten ausgewählt werden: Mindestgeschwindigkeit (1), niedrige Geschwindigkeit (2), normale Geschwindigkeit (3) und hohe Geschwindigkeit (4).
-  **Waschrhythmus:** Bewegungsablauf, den die Waschmaschine ausführen soll (Betriebsdauer (Sekunden) / Stillstandszeit (Sekunden)). Der einstellbare Bereich beträgt von 1 bis 99. Die Trommel dreht abwechselnd nach links und rechts.

- 
Wassereinlass: Anzeige des ausgewählten Wassereinlasses.
 - Warmwasser: Wasserfüllung ab dem Warmwasseranschluss (ja/nein)
 - Kaltwasser: Wasserfüllung ab dem Kaltwasseranschluss (ja/nein)
 - Hilfswasser: Wasserfüllung ab dem Hilfswasseranschluss (ja/nein)
 - Wassereinstellung: Temperaturabhängige Wasserfüllung ab einem bestimmten Einlass (ja/nein).
 - T1, T2, T3: Wasserfüllung eines der Behälters bei eingebauter Wasserrückgewinnung.
- 
Abfluss: Hier wird angezeigt, ob das Ablassen des Wassers bei Beendigung der Programmphase erfolgen soll. Bei eingeschalteter Wasserrückgewinnung wird in diesem Fall der entsprechende Ausgang angegeben.
- 
Abkühlung: Option zur Abkühlung der Temperatur in einer vor dem Ablassen befindlichen Programmphase bzw. im Anschluss an die nächste Phase. Dieser Parameter kann nur dann eingestellt werden, wenn die Temperatur der entsprechenden Programmphase mindestens 40 °C (104°F) beträgt. Der einstellbare Bereich beträgt zwischen 30 °C (86°C) und dem Sollwert der jeweiligen Programmphase. Zusätzlich zur Auswahl des Wertes für die Abkühlung ist eine Taste zum Freischalten bzw. Sperren dieser Option vorgesehen.
- 
Dosierung 1..8: Jede einzelne Dosierung kann unabhängig eingeschaltet werden. Dazu müssen die folgenden Parameter eingestellt werden:
 - Start: Ist die Dosierung X eingeschaltet, muss angegeben werden, wann genau diese Dosierung starten soll





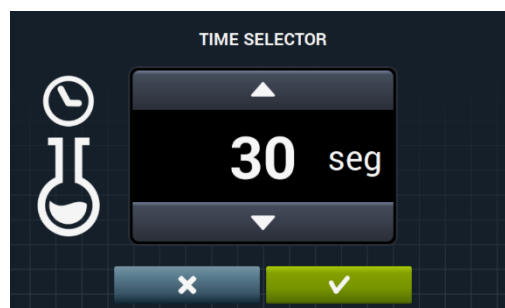

- Sicherheitspegel (ML): Die Dosierung beginnt bei Erreichen des Sicherheitspegels.
- Wasserstand (L): Die Dosierung beginnt bei Erreichen des festgelegten Wasserstands.
- Temperatur (T): Die Dosierung beginnt bei Erreichen der festgelegten Temperatur.
- Dauer: Dauer der Dosierung X in Sekunden. Der einstellbare Bereich beträgt zwischen 0 und 99.

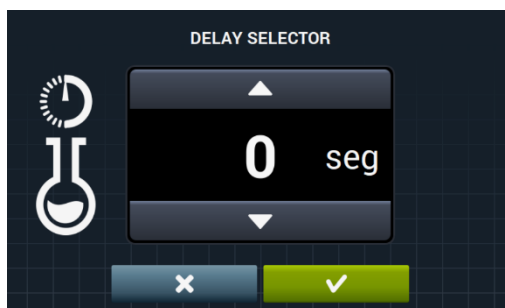







- **Verzögerung:** Verzögerung der Dosierung X in Sekunden X. Ab Erreichen der Startstelle wird die Dosierung für die angegebene Zeit verzögert. Der einstellbare Bereich beträgt zwischen 0 und (Phasendauer minus Dosierungsdauer).

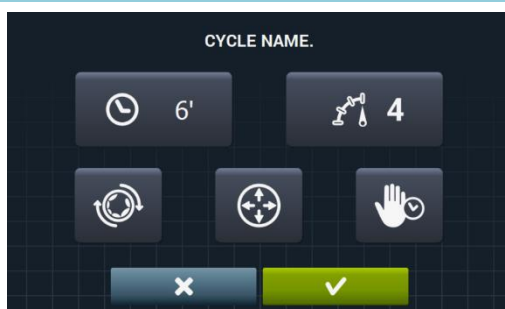

-  **Bewegung bei Füllung:** Trommeldrehung während des Füllvorgangs (ja/nein).
-  **Bewegung während des Abflusses:** Trommeldrehung während der Entleerung (ja/nein).
-  **Thermo-Stillstand:** Hier wird der Zeitpunkt angegeben, ab dem die für die entsprechende Programmphase festgelegte Dauer gezählt wird (ja/nein).
-  **Programmpause:** Hier kann vor der Ausführung der entsprechenden Programmphase ein Programmhalt vorgenommen werden. Der jeweilige Programmhalt wird auf dem Bildschirm und durch ein akustisches Signal angezeigt (ja/nein).
Ist dieser Parameter aktiviert, so wechselt die Waschmaschine vor Beginn der jeweiligen Programmphase in den Zustand „Pause“. Auf dem Bildschirm erscheint in diesem Fall die Meldung „Programmierte Pause“. Die Taste PLAY drücken, um die Ausführung des Programms fortzusetzen.

3.1.2 Parameter für die Schleuderphasen:



-  **Dauer:** Wertangabe der Schleuderzeit in Minuten. Der einstellbare Bereich beträgt von 1 bis 99.
-  **Geschwindigkeit:** Schleudergeschwindigkeit. Es können 4 verschiedene Geschwindigkeiten ausgewählt werden: Mindestgeschwindigkeit (1), normale Geschwindigkeit (2), mittlere Geschwindigkeit (3) und Höchstgeschwindigkeit (4). Die Werte für mittlere Geschwindigkeit (3) und Höchstgeschwindigkeit (4) sind nur im Falle der Hoch- und Mittelgeschwindigkeits-Waschmaschinen vorhanden. Einstellbarer Bereich.
-  **Auflockerung:** Auflockerung am Ende der Schleuderphase (ja/nein).
-  **Optimale Verteilung:** Ist diese Option eingeschaltet, so wird in der vorherigen Programmphase kein Wasser abgelassen.
-  **Programmpause:** Hier kann vor der Ausführung der entsprechenden Programmphase ein Programmhalt vorgenommen werden. Der jeweilige Programmhalt wird auf dem Bildschirm und durch ein akustisches Signal angezeigt (ja/nein).

3.2 Phasen-Bibliothek















Hierbei handelt es sich um die Programmphasen, die in der Phasen-Bibliothek enthalten und bei der Erstellung neuer Programme behilflich sind.

- Einweichen
 - **F1:** Einweichen
- Vorwäsche
 - **F2:** Normale Vorwäsche kalt
 - **F3:** Normale Vorwäsche 40°C (104°F)
 - **F4:** Vorwäsche empfindlich kalt
 - **F5:** Vorwaschen empfindlich 40°C (104°F)
 - **F6:** Vorwäsche sehr empfindlich kalt
 - **F7:** Vorwäsche sehr empfindlich 40°C (104°F)
 - **F8:** Vorwäsche wet
- Waschprogramme
 - **F9:** Normale Hauptwäsche kalt
 - **F10:** Normale Hauptwäsche 60°C (140°F)
 - **F11:** Normale Hauptwäsche 90°C (194°F)
 - **F12:** Hauptwäsche empfindlich kalt
 - **F13:** Hauptwäsche empfindlich 40°C (104°F)
 - **F14:** Hauptwäsche sehr empfindlich kalt
 - **F15:** Hauptwäsche sehr empfindlich 40°C (104°F)
 - **F16:** Hauptwäsche wet kalt
 - **F17:** Hauptwäsche wet 40°C (104°F)
- Klarspülgänge
 - **F18:** Normales Klarspülen
 - **F19:** Normales abschließendes Klarspülen
 - **F20:** Klarspülen empfindliche Wäsche
 - **F21:** Empfindlich abschließendes Klarspülen
 - **F22:** Klarspülen sehr empfindlich
 - **F23:** Sehr empfindlich abschließendes Klarspülen
 - **F24:** Klarspülen wet
 - **F25:** Abschließendes Klarspülen wet
- Schleudergänge
 - **F26:** Langes Schleudern
 - **F27:** Kurzes Schleudern

































Symbole der verschiedenen Programmphasen:

	Einweichen	
	Vorwäsche	: Vorwäsche kalt, 40: Vorwäsche 40 °C (104°F), ...
	Hauptwasch- gänge	
	Klarspülgänge	: Klarspülen, : Abschließendes Klarspülen mit Weichspüler
	Schleuder- gänge	

Symbole und Werte der verschiedenen Parameter:

	Dauer	Wert in Minuten
	Temperatur	Wert in °C (°F)
	Wasserstand	1: Mindestpegel, 2: niedriger Wasserstand, 3: mittlerer Wasserstand, 4: hoher Wasserstand, 5: Höchstpegel
	Waschgeschwindigkeit	1: Mindestgeschwindigkeit, 2: niedrige Geschwindigkeit, 3: normale Geschwindigkeit, 4: Hohe Geschwindigkeit
	Schleudergeschwindigkeit	2: normale Schleudergeschwindigkeit, 3: mittlere Schleudergeschwindigkeit 4: höchste Schleudergeschwindigkeit
	Wassereinlass	0: kalt, 1: kalt/warm, je nach Einstellung
	Waschrhythmus	Betriebsdauer (Sekunden) ; Stillstandszeit (Sekunden)
	Bewegen Füllen	✓ : Ja
	Thermo-Stillstand	✓ : Ja
	Bewegung während des Abflusses	✓ : Ja
	Abfluss	✓ : Ja
	Abkühlung	✓ : Ja
	Optimale Verteilung:	✓ : Ja
	Programmpause	✓ : Ja
	Auflockerung	✓ : Ja
D	Dosierung	Einlass an der Stelle, an der die Dosierung erfolgt (D1: Dosierung 1, ...), mit START/DAUER/VERZÖGERUNG auf ML/0/30 eingestellt.

Tabellen der verschiedenen Programmphasen mit den entsprechenden Parametern:

	F1		F2	F3	F4	F5	F6	F7	F8
			 	 40	 	 40	 	 40	 
	3		5	5	6	6	6	6	5
	3			40		40		40	
	3		1	1	3	3	3	3	3
	0		3	3	2	2	2	2	1
	15;05		0	1	0	1	0	1	0
	✓		15;05	15;05	10;08	08;06	5;15	5;15	02;02
	✓		✓	✓					✓
	✓			✓		✓		✓	
			✓	✓					✓
			✓	✓	✓	✓	✓	✓	✓
D		D	D1	D1	D1	D1	D1	D1	D1

	F9	F10	F11	F12	F13	F14	F15	F16	F17
	10	10	10	12	12	12	12	10	10
		60	90		40		40		40
	1	1	1	1	1	1	1	2	2
	3	3	3	2	2	2	2	1	1
	0	1	1	0	1	0	1	0	1
	15;05	15;05	15;05	10;08	10;08	05;15	05;15	02;02	02;02
	✓	✓	✓					✓	✓
		✓	✓		✓		✓		✓
	✓	✓	✓					✓	✓
	✓	✓	✓	✓	✓	✓	✓	✓	✓
D	D2, D3	D2, D3	D2, D3	D2	D2	D2	D2	D2	D2

	F18	F19	F20	F21	F22	F23	F24	F25
	2	2	3	3	3	3	2	2
	4	4	4	4	4	4	4	4
	3	3	2	2	2	2	1	1
	15;05	15;05	10;08	10;08	05;15	05;15	02;02	02;02
	✓	✓					✓	✓
	✓	✓					✓	✓
	✓	✓	✓	✓	✓	✓	✓	✓
D		D4		D4		D4		D4

	F26	F27
	2	6
	2	4
	✓	✓
	✓	✓

3.3 Programm-Bibliothek

Die folgenden Programme sind defaultmäßig in der Programm-Bibliothek enthalten:

P1: Energieeffizienz 90°C (194°F)	P10: Sehr empfindliche Wäsche kalt
P2: Energieeffizienz 60°C (140°F)	P11: Sparprogramm 90°C (194°F)
P3: Energieeffizienz 30°C (86°F)	P12: Sparprogramm 60°C (140°F)
P4: Energieeffizienz Kaltwäsche	P13: Sparprogramm 30°C (86°F)
P5: Normalwaschgang 60°C (140°F)	P14: Sparprogramm kalt
P6: Normalwaschgang 30°C (86°F)	P15: Schleuse
P7: Normalwaschgang kalt	P16: Langes Schleudern
P8: Empfindliche Wäsche 40°C (104°F)	P17: Kurzes Schleudern
P9: Empfindliche Wäsche kalt	



Die Tabelle mit allen Programmen, sowie den zugehörigen Parametern finden Sie auf den letzten Seiten dieses Handbuchs.

4 EINSTELLUNG

Im Folgenden wird das Hauptmenü für die Einstellung der Waschmaschine gezeigt. Von hier aus können die verschiedenen Parameter des Gerätes eingestellt und die bereits im System vorhandenen Daten angezeigt bzw. heruntergeladen werden.

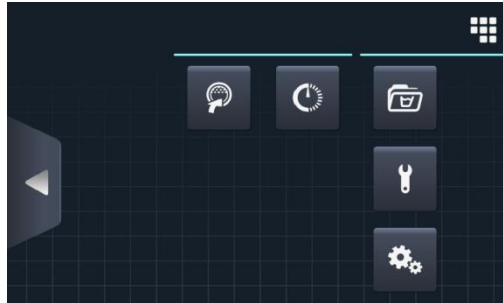
Der Zugang zu diesem Menü erfolgt über das zum **Hauptbildschirm** gehörende Symbol  (siehe Abschnitt 2.2)





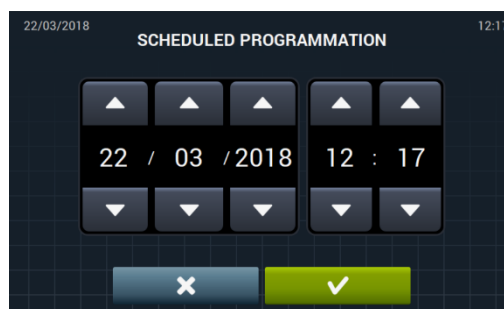

-  **Easy load:** Diese Option ist beim Einfüllen der Wäsche behilflich.
-  **Verzögerte Programmierung:** Diese Funktion ermöglicht es, einen Hauptwaschgang zu verzögern und an dem gewünschten Datum bzw. zur gewünschten Uhrzeit auszuführen. Nach Drücken der Taste „Verzögerte Programmierung“ fragt das System nach der Eingabe des gewünschten Datums und der Uhrzeit.

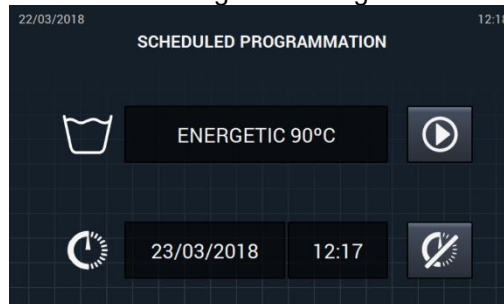

Anschließend werden das Datum und die Uhrzeit des entsprechenden Programms zusammen mit der Nummer und dem Namen des Programms eingeblendet.



-  Das Programm vor der eingestellten Uhrzeit ausführen.
-  Die vorgenommene Programmierung abbrechen.
-  **Programmverwaltung:** Verwaltung aller gespeicherten Programme, sowie der zu diesem Zeitpunkt aktiven Programme (siehe Abschnitt 4.1)
-  **System einstellen:** Einstellung der verschiedenen Bereiche der Waschmaschine (siehe Abschnitt 4.2)
-  **Wartung:** Hier sind verschiedene Optionen für den Techniker vorgesehen, die durch ein Passwort geschützt sind.



4.1 Programmverwaltung

Dieses Untermenü dient zur Verwaltung aller Programme. Das gilt sowohl für die vom Anwender ausgewählten als auch die in der Bibliothek verfügbaren Programme. Hierzu muss die entsprechende Auswahl zwischen „Phasen-Bibliothek“, „Meine Programme“ und „Programm-Bibliothek“ getroffen werden.

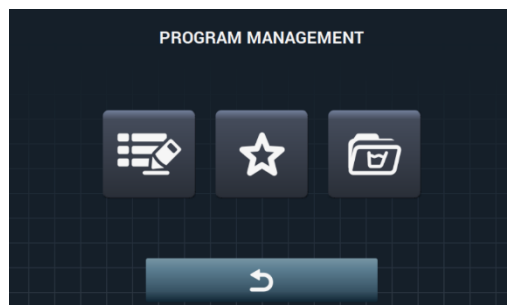
Zugang: [Hauptbildschirm]  ⇒ [Hauptmenü] 





Das System verfügt über eine Bibliothek, in der alle Programme und Phasen einschließlich der defaultmäßigen Programme und der vom Anwender angelegten bzw. importierten Programme gespeichert werden.

-  **Meine Programme:** Diese Funktion ist auf dem Hauptbildschirm OPL verfügbar (siehe Abschnitt 4.1.1).
-  **Programm-Bibliothek:** (siehe Abschnitt 4.1.2).
-  **Phasen-Bibliothek:** (siehe Abschnitt 4.1.3).

4.1.1 Meine Programme (Favoritenliste).

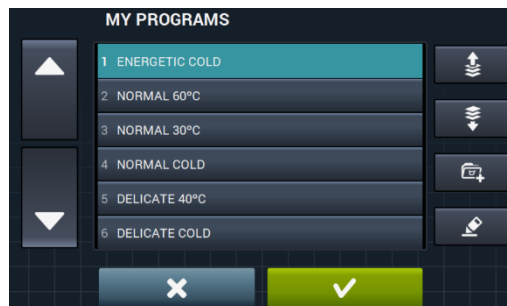
Bei den in dem Verzeichnis „Meine Programme“ vorhandenen Programmen handelt es sich um die auf dem Hauptbildschirm OPL verfügbaren.





-  **Programme hinzufügen bzw. entfernen:** Nach Drücken der Tasten erfolgt der Zugang zur Programm-Bibliothek. Hier sind die zur Zeit in „Meine Programme“ enthaltenen Programme hervorgehoben, die einzeln an- bzw. abgewählt und so in die Favoritenliste aufgenommen bzw. aus ihr entfernt werden können.

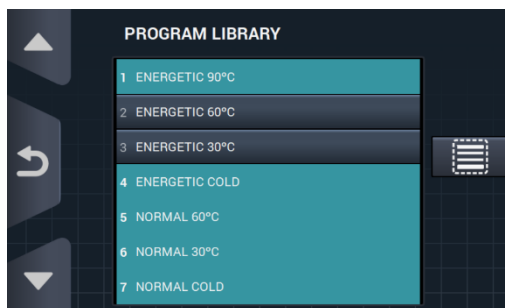

- **Alles an- bzw. abwählen:** Mit dieser Funktion wird die vollständige Liste der Programm-Bibliothek an- bzw. abgewählt.



-  **„Pfeil nach oben“** und  **„Pfeil nach unten“:** Durch Drücken dieser Tasten kann die Stellung aller Programme in der Favoritenliste beliebig geändert werden.
-  **Taste zum Bearbeiten:** Durch Drücken dieser Taste kann das ausgewählte Programm genauso wie von der Programm-Bibliothek aus geändert werden.



Nach Drücken von „OK“ oder „Cancel“ erfolgt die Rückkehr zu „Meine Programme“.

4.1.2 Programm-Bibliothek

Hier können Programme hinzugefügt, geändert oder gelöscht werden. Außerdem können neue Programme importiert oder auf einen externen USB-Speicher exportiert werden.

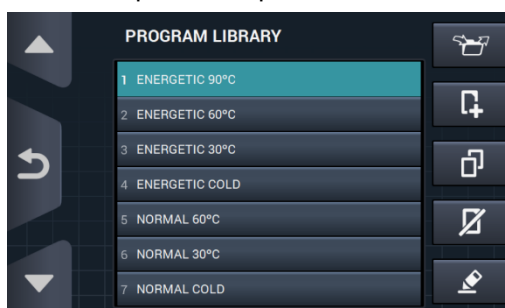

-  **Programm anlegen:** Anlegen neuer Waschprogramme auf Grundlage der in der Bibliothek vorhandenen Phasen. Nach Drücken dieser Taste fragt das System nach Eingabe eines Namens für das neue Programm.

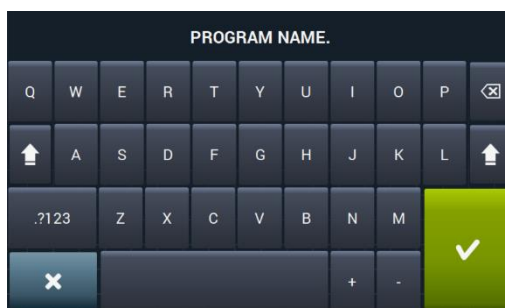

Anschließend erscheint der folgende Bildschirm (ohne Phasen), um die gewünschten Phasen aus der Bibliothek einfügen zu können.

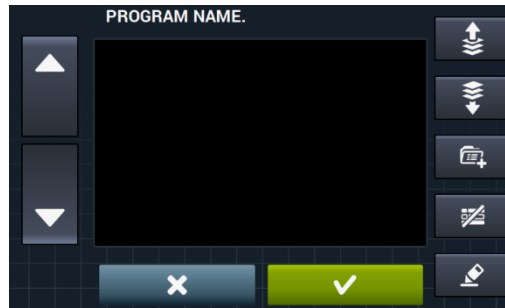

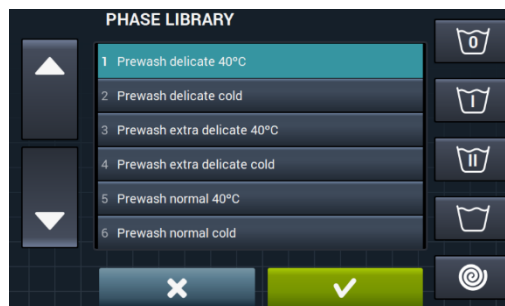

Die Phasen, die aus der Bibliothek eingefügt werden, können je nach Phasenart gefiltert und entsprechend angezeigt werden.



Nach erfolgter Auswahl der Programmphase können die Parameter der in der Bibliothek vorhandenen Phasen vor Aufnahme in das gerade angelegte Programm abgefragt werden.



Jedes Programm besteht aus einer Reihe Parameter, die nach Phasen zusammengestellt sind und keinerlei Beziehung zu den in der Bibliothek vorhandenen Phasen haben.





- 
Programm kopieren: hier kann ein bereits in der Bibliothek vorhandenes Programm kopiert und mit einem neuen Namen versehen werden.
- 
Programm ändern: hier können sowohl der Name des Programms als auch der Phasen, aus denen sich das Programm zusammensetzt, geändert werden. Weiterhin können hier Phasen hinzugefügt, geändert oder gelöscht bzw. ihre Reihenfolge verändert werden. Genauso wie beim Anlegen eines neuen Programms können hier die Phasen aus der Phasen-Bibliothek hinzugefügt bzw. gelöscht werden. Beim Anlegen der Programme können lediglich die Parameter der verschiedenen Phasen abgefragt werden. Beim Ändern dagegen ist es möglich, die bereits im Programm vorhandenen Phasen ebenfalls zu verändern.
- 
Programm löschen: Löschen der in der Bibliothek gespeicherten Programme.

- 
Programm importieren bzw. exportieren: Hier können Programm von einem externen USB-Speicher importiert bzw. exportiert werden.



- 
Programm importieren: hier können neue Programm von einem externen USB-Speicher importiert werden. Bei Zugriff auf den USB-Speicher werden lediglich die Dateien mit der Erweiterung *.prg und die entsprechenden Verzeichnisse angezeigt.

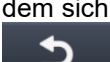

- 
Marker: Hier wird die Anzahl der angewählten Programme angezeigt.
- 
Alles an- bzw. abwählen: Hier können alle Programme aus dem Verzeichnis, in dem sich der Anwender gerade befindet, an- bzw. abgewählt werden.
- 
Zurück: Diese Funktion dient zum Verlassen des Verzeichnisses, in dem sich der Anwender gerade befindet. Wird ein Programm importiert, das den gleichen Namen wie ein bereits vorhandenes Programm hat, so fragt das System den Anwender, ob er das Programm ersetzen oder den Vorgang abbrechen möchte. Da dieser Fall bei vielen Programmen gleichzeitig auftreten kann, gibt es ein Kästchen zur Auswahl der Funktion „Immer den gleichen Befehl ausführen“.
- 
Programm exportieren: hier können in der Bibliothek vorhandene Programme auf einen externen USB-Speicher exportiert werden.



Die zu exportierenden Programme können ausgewählt werden.

- 
Favoriten an- bzw. abwählen: Hier können alle Programme oder alle Programme in der Favoritenliste ausgewählt werden. Hierbei wird stets die Anzahl der ausgewählten Programme angezeigt.

Die ausgewählte Programmgruppe wird in einem bestimmten Verzeichnis (PROGRAMMS im Stammverzeichnis des USB-Speichers) abgelegt, wobei jedes Programm in einer eigenen Datei dargestellt wird.

4.1.3 Phasen-Bibliothek

Von der Phasen-Bibliothek aus können die Namen jeder einzelnen Phase geändert werden. Nach erfolgter Einfügung in ein Programm wird allerdings ein anderer Name für die Phase in der Phaseninformation angezeigt. Hierbei handelt es sich um einen so genannten dynamischen Namen, der aus der Phasenart und einem Parameter (Temperatur, UpM) besteht.

Die Phasen-Bibliothek kann bearbeitet werden, so dass die neue Phasen angelegt bzw. vorhandene Phasen geändert oder gelöscht werden können (Siehe Abschnitt 3.1).



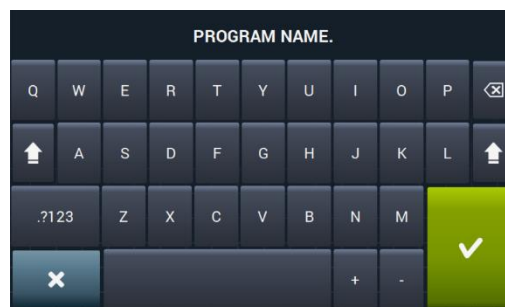

-  **Phase anlegen:** Hier können neue Waschphasen angelegt werden. Nach Drücken dieser Taste fragt das System nach Eingabe eines Namens für das neue Programm.

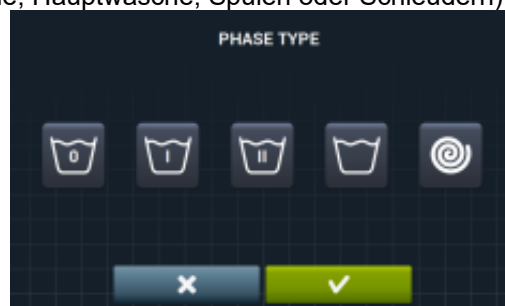

Anschließend wird der folgende Bildschirm eingeblendet, so dass die anzulegende Phasenart (Einweichen, Vorwäsche, Hauptwäsche, Spülen oder Schleudern) ausgewählt werden kann.







-  **Phase kopieren:** Hier kann eine bereits in der Bibliothek vorhandene Phase kopiert und mit einem neuen Namen versehen werden.
-  **Phase löschen:** Hier können die in der Bibliothek gespeicherten Phasen gelöscht werden.
-  **Phase ändern:** Hier können die zur ausgewählten Phase gehörenden Parameter geändert werden.

4.2 System einstellen

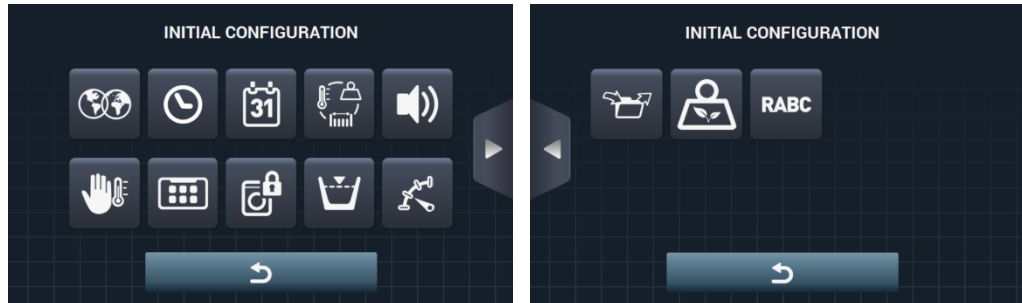
Zugang: [Hauptbildschirm]  ⇒ [Hauptmenü] 

In der Systemeinstellung können folgende Einstellungen vorgenommen werden:



-  **Nächster Bildschirm.**
-  **Vorheriger Bildschirm.**
-  **Sprache:** Die Anzeigetexte der Waschmaschine können in 34 verschiedenen Sprachen angezeigt werden. Die Bearbeitung dieser Texte kann allerdings nur mit westlichen Schriftzeichen erfolgen.

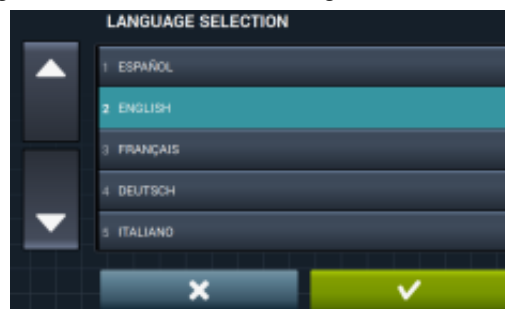

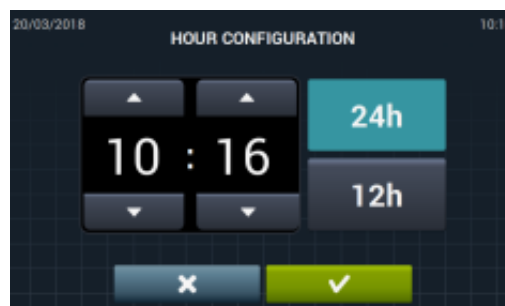

-  **Uhrzeit:** Einstellen der aktuellen Uhrzeit. Das angezeigte Format kann ausgewählt werden (12 Stunden / 24 Stunden (defaultmäßige Einstellung)).



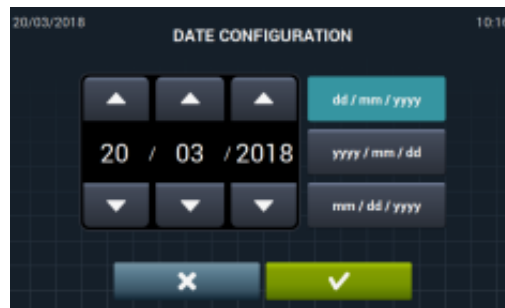

DEUTSCH

- 
Datum: Einstellen des aktuellen Datums. Das angezeigte Format kann ausgewählt werden (dd/mm/yyyy (defaultmäßige Einstellung) / yyyy/mm/dd / mm/dd/yyyy).



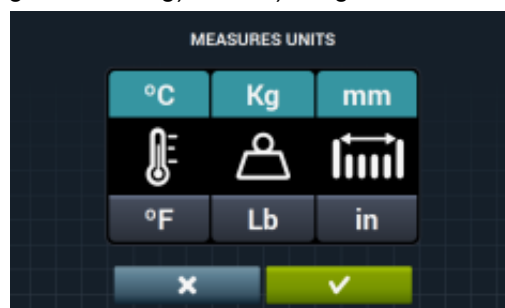

- 
Maßeinheiten: Hier kann die gewünschte Maßeinheit zur Anzeige der Temperatur (°C (defaultmäßige Einstellung) bzw. °F), des Gewichts (kg (defaultmäßige Einstellung) bzw. Lb) und die Größe (mm (defaultmäßige Einstellung) bzw. in) ausgewählt werden



- 
Thermo-Stillstand: Allgemeine Einstellung des Thermo-Stillstands. Ist diese Funktion ausgeschaltet, so erfolgt kein Thermo-Stillstand. Es erfolgt auch dann kein Thermo-Stillstand, wenn dieser Parameter in der in Ausführung befindlichen Phase ausgewählt ist. Ist diese Funktion dagegen eingeschaltet, so wird die Einstellung der verschiedenen Phasen unverändert gelassen und entsprechend angewandt. Defaultmäßige Einstellung: eingeschaltet. Bei den Geräten ohne Aufheizvorgang (HW) ist diese Funktion ständig deaktiviert.





- 
Wassereinsparung bei schwerer Wäsche: Die gewünschte Wassereinsparung für schwere Wäsche kann bedarfsgerecht eingestellt werden. Hierzu kann zwischen 3 folgenden verschiedenen Optionen und 3 Einsparstufen gewählt werden. Je nach Trommelfüllung erfolgt die entsprechende Senkung des Wasserstands und der Dosierung an Waschmittel.

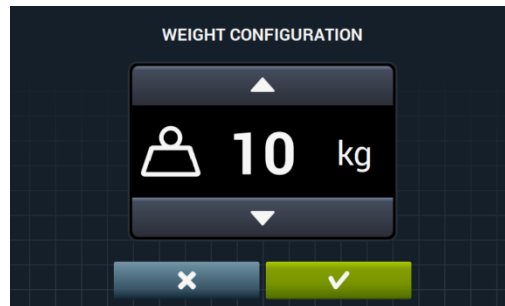

-  Option für schwere Wäsche deaktiviert.
-  Automatische Option für schwere Wäsche. Die Option ist auf Grundlage der Einstellung der vorhandenen Zubehörsätze verfügbar.
-  Manuelle Option für schwere Wäsche. In diesem Fall wird das Gewicht der Wäsche nach Drücken der Gewichtstaste auf dem Hauptbildschirm von Hand eingegeben (siehe Abschnitt 2.2, Punkt 3).

- 
 Intelligente Option für schwere Wäsche. Dank dieser Option schätzt das System eigenständig das Gewicht zu Beginn der jeweiligen Programmausführung. Die Meldung LOAD DETECTION wird während der Ausführung dauerhaft eingeblendet. Die Ausführung dieser Option kann einige Minuten dauern. Die hierfür verwendete Zeit ist nicht in der Programmdauer enthalten.



- 
 Option zur Einsparung deaktiviert.
- 
 Option für niedrige Einsparung.
- 
 Option für mittlere Einsparung.
- 
 Option für hohe Einsparung.

- 
Wasserstände: Hier können die 5 einstellbaren Wasserstände in mm eingestellt werden. Jedem dieser Wasserstände sind ein defaultmäßiger Wert und ein Einstellbereich zugeordnet. Diese Werte sind je nach ausgewähltem Modell unterschiedlich. (Siehe die Tabelle der Wasserstände für die verschiedenen Modelle).



- 
Wasserstände: Hier können die 5 einstellbaren Wasserstände in mm eingestellt werden. Jedem dieser Wasserstände sind ein defaultmäßiger Wert und ein Einstellbereich zugeordnet. Diese Werte sind je nach ausgewähltem Modell unterschiedlich. (Siehe die Tabelle der Wasserstände für die verschiedenen Modelle).

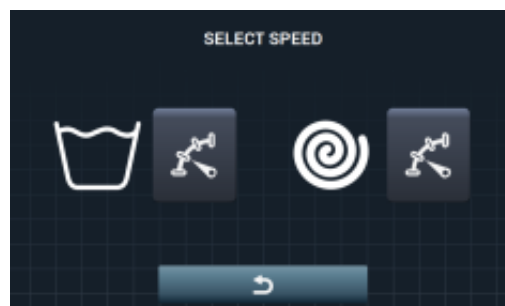



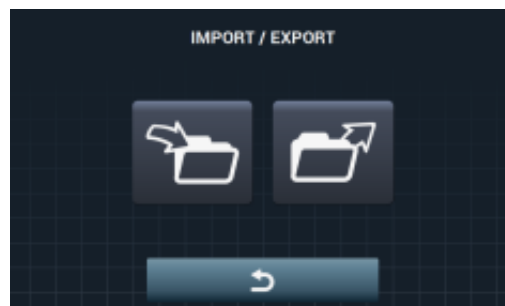

- 
Einstellung importieren bzw. exportieren: Hier kann eine Maschineneinstellung von einem USB-Speicher importiert bzw. eine aktuelle Maschineneinstellung auf einen USB-Speicher exportiert werden. Nach Drücken dieser Taste erscheint ein Übergangsbildschirm, der die Auswahl zwischen Importieren und Exportieren ermöglicht (wie auch bei den Programmen).



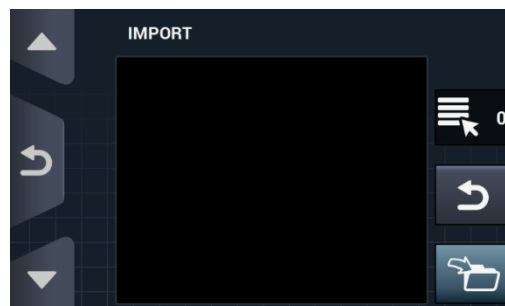

Wird die Funktion IMPORTIEREN ausgewählt, so erscheint der Bildschirm zum Navigieren auf dem USB-Speicher. Allerdings können in diesem Fall ausschließlich Einstellungsdateien ausgewählt werden (Erweiterung *.cfg).



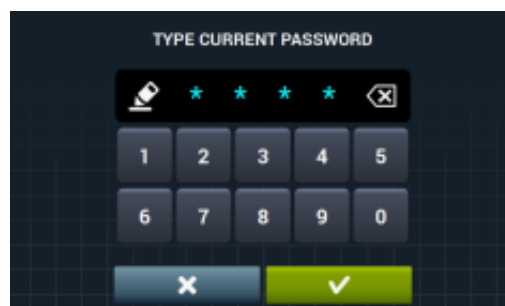

Wird die Funktion EXPORTIEREN ausgewählt, so wird die aktuelle Maschineneinstellung im Stammverzeichnis des USB-Speichers in dem Verzeichnis CONFIGS gespeichert. Jede der Konfigurationsdateien wird wie folgt benannt: KONFIG_ModelL_Datum_Uhrzeit.cfg.

- 
Beschränkter Zugang: Hier kann der Zugang zur Einstellung der Waschmaschine beschränkt werden. In diesem Fall benötigt der Anwender das Passwort, um in das Hauptmenü zu gelangen. Defaultmäßige Einstellung: ausgeschaltet. Das gewünschte Passwort für den Zugang zum Hauptmenü kann eingestellt werden (defaultmäßige Einstellung: 1234).



- 
HUD: Die Einstellung HUD ermöglicht das Ein- bzw. Ausblenden der Anzeige der Parameter auf den verschiedenen Bildschirmen (siehe Abschnitt 4.2.1).



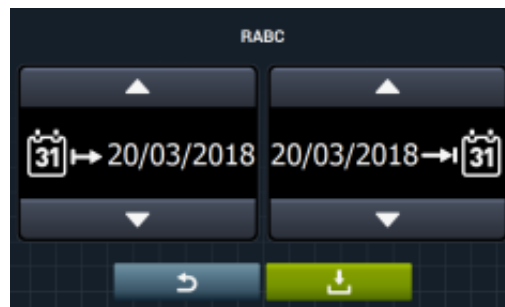

- 
Beep: Diese Option dient zum Ausschalten des Summers. Defaultmäßige Einstellung: eingeschaltet.
- 
RABC/Rückführbarkeit: Folgende Informationen zu jedem Waschvorgang werden gespeichert: Zu Beginn des Zyklus: Programm, Startzeit, Gewicht (falls vorhanden). Während der Ausführung, alle 15 Sekunden: Wasserstand, Temperatur und Fehler (falls vorhanden). Beim Herunterladen der Datum muss der jeweils gewünschte Zeitraum angegeben werden (defaultmäßig entspricht der jeweilige Tag dem Datum für den Start und das Ende). Diese Daten werden mindestens 15 Tage lang gespeichert. Bei jedem Download wird eine RABC-Datei im Stammverzeichnis des USB-Speichers angelegt. Jede der rabc-Dateien wird wie folgt benannt: RABC_Modell_Datum_Uhrzeit.rabc.



4.2.1 HUD-Einstellung

Einstellung der Parameter, die auf dem *OFF-Bildschirm*, dem *Hauptbildschirm* und dem *Ausführungsbildschirm* angezeigt werden sollen. Zusätzlich ist die Einstellung für automatisches Ausschalten und Energieeinsparung verfügbar.

Zugang: [Hauptbildschirm]  ⇒ [Hauptmenü]  ⇒ [System einstellen] 

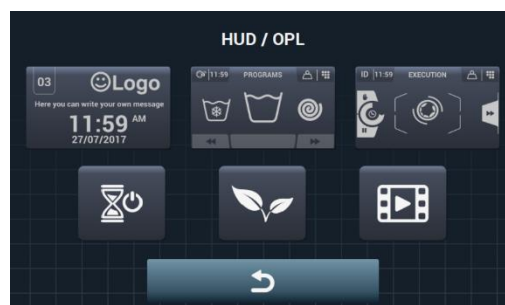



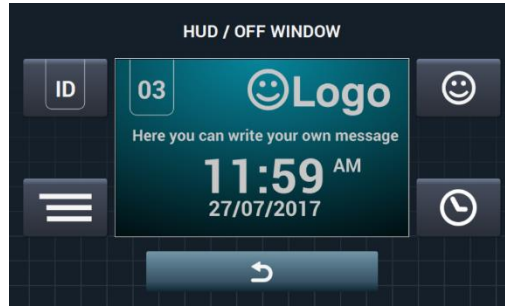

- **Bildschirm OFF:** Hier können die folgenden Parameter eingestellt werden:

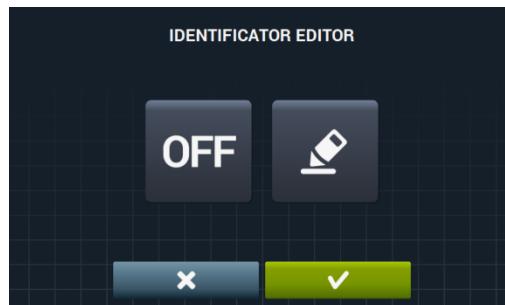

- **ID** **Gerätekenzeichner:** Die Kennzeichnung des Gerätes kann hier ein- bzw. ausgeblendet werden. Zusätzlich kann dem Gerät eine beliebige Nummer zwischen 1 und 99 zugeordnet werden. Defaultmäßige Einstellung: ausgeblendet. Dieser Kennzeichner ist zur Herstellung der Fernkommunikation zwingend erforderlich.



Die Aktivierung des Gerätekenzeichners erfolgt durch Drücken der Taste OFF **OFF** und anschließendes Betätigen der Bearbeitungstaste .



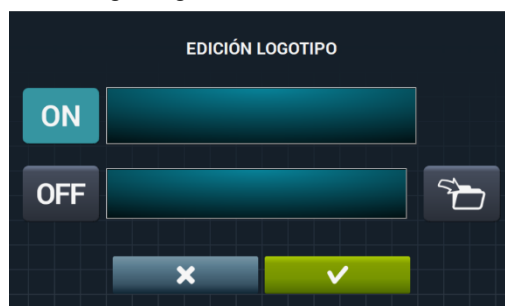

- **Datum:** Diese Option kann hier ein- bzw. ausgeschaltet werden. Defaultmäßige Einstellung: eingeschaltet.
- **Logo:** Hier kann ausgewählt werden, ob das Logo angezeigt werden soll oder nicht. Defaultmäßige Einstellung: eingeschaltet.

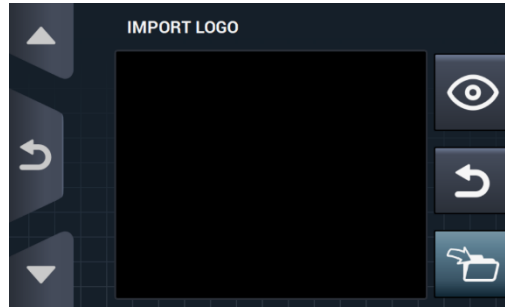

Nach Drücken der Importtaste , kann ein Logo von einem externen USB-Speicher in das Gerät importiert werden. Die zum Logo gehörende Datei muss das Format *.png und eine Auflösung von 290 x 80 Pixel aufweisen.





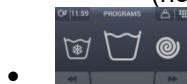

Die Vorschau-Taste , dient zum Sicherstellen, dass das Logo ordnungsgemäß angezeigt wird.

-  **Meldung Wäscherei:** Der Anwender kann diese Start-Meldung hier bearbeiten (höchstens 40 Zeichen bzw. Buchstaben). Defaultmäßige Einstellung: ausgeblendet.

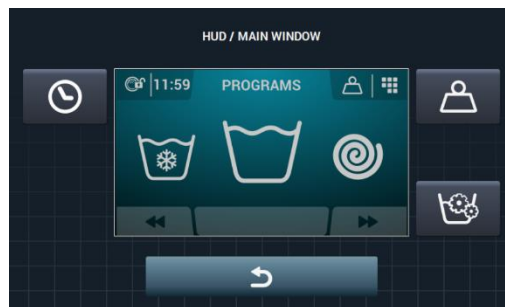

- **Hauptbildschirm:** Im Folgenden finden Sie die einstellbaren Parameter:









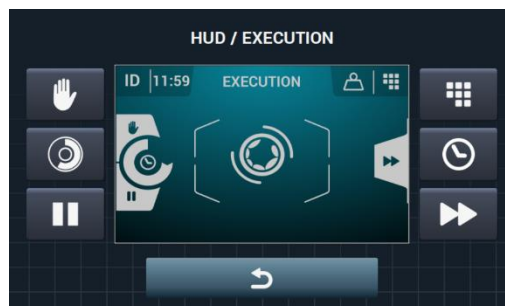

-  **Uhrzeit:** Diese Option dient zum Ein- bzw. Ausblenden der Uhrzeit. Defaultmäßige Einstellung: eingeblendet.
-  **Wäschegewicht:** Wird diese Option ausgeschaltet, ist das Symbol für das Gewicht nicht zu sehen. Defaultmäßige Einstellung: ausgeschaltet.
-  **Sofortige Programmierung:** Ist die sofortige Programmierung ausgeschaltet, so können die Parameter der jeweiligen Phase eingesehen, aber nicht bearbeitet werden. Defaultmäßige Einstellung: eingeschaltet.



- **Ausführungsbildschirm.** Folgende Optionen sind auf dem Ausführungsbildschirm verfügbar:



-  **Uhrzeit:** Diese Option dient zum Ein- bzw. Ausblenden der Uhrzeit. Defaultmäßige Einstellung: eingeblendet.
 -  **Restzeit:** Diese Option ermöglicht es, die gesamte Restzeit und die Fortschrittsanzeige für das Programm auf dem Ausführungsbildschirm ein- bzw. auszublenden. Defaultmäßige Einstellung: eingeblendet.
 -  **Taste zum Anhalten: STOP:** Die Taste zum Anhalten kann hier ausgeblendet werden. Defaultmäßige Einstellung: eingeblendet.
 -  **PAUSE-Taste:** Die Pause-Taste kann hier ausgeblendet werden. Defaultmäßige Einstellung: eingeblendet.
 -  **Menü-Taste:** Diese Option ermöglicht das Ein- bzw. Ausblenden des Symbols für das Ausführungsmenü. Defaultmäßige Einstellung: ausgeschaltet.
 -  **Vorlauf-Taste:** Diese Funktion ermöglicht es, die Vorlauf-Taste und die Informationen in Bezug auf die nächste Programmphase auszublenden. Defaultmäßige Einstellung: eingeblendet.
-  **Automatisches Ausschalten:** Ist diese Option eingeschaltet und der Anwender befindet sich auf dem Hauptbildschirm, so wechselt das System auf den *OFF-Bildschirm*, wenn 30 Minuten lang keine Handlung ausgeführt worden ist. Defaultmäßige Einstellung: eingeschaltet.
 -  **Energieeinsparung:** Diese Option ermöglicht eine Energieeinsparung durch Ausschalten der Hintergrundbeleuchtung des Bildschirms 10 Minuten nachdem sich die Waschmaschine ausgeschaltet hat. Die Hintergrundbeleuchtung geht erneut an, sobald der Bildschirm berührt wird, und wird auf den Hauptbildschirm übertragen. Defaultmäßige Einstellung: eingeschaltet.
 -  **Video importieren:** Nach 10 Minuten Inaktivität kann ein Videofilm auf dem Gerätebildschirm abgespielt werden. Wird die Funktion „Energieeinsparung“ eingeschaltet, so erfolgt automatisch die Deaktivierung der Wiedergabe des Videofilms.

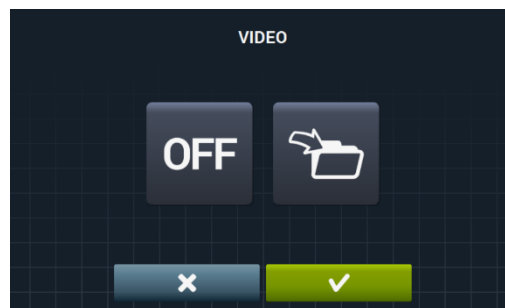

Nach Drücken der Importtaste , kann ein Videofilm von einem externen USB-Speicher in das Gerät importiert werden. Es können ausschließlich Videodateien (avi, mov, etc.) importiert werden und es kann nur eine einzige Videodatei in das Gerät installiert werden. Die werkseitig empfohlene Auflösung beträgt 480x272 Pixel für Geräte mit 4,3-Zoll-Bildschirm und 800x480 Pixel für Geräte mit 7-Zoll-Bildschirm. Der Hersteller rät davon ab, 16 Fps zu überschreiten. Die höchstzulässige Dateigröße beträgt 25 Mb.

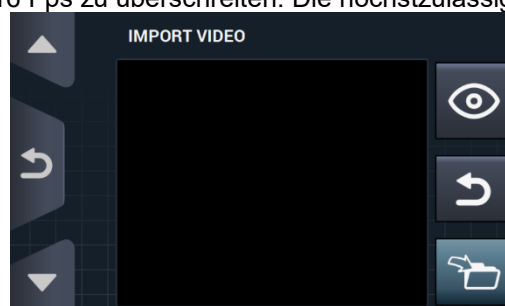

Die Vorschau-Taste , dient zum Sicherstellen, dass die Videodatei ordnungsgemäß angezeigt wird.

5 WARTUNG

5.1 Elektrische und mechanische Fehlerbehebung

Bevor Sie sich an Ihren zuständigen Kundendienst wenden, nehmen Sie bitte folgende Überprüfungen vor:

- Ordnungsgemäße Stromversorgung des Gerätes.
- Zustand der Sicherungen.
- Netzspannung und Gerätespannung stimmen überein.

Erreicht die Waschmaschine den erforderlichen Wasserstand nicht, führen Sie bitte folgende Überprüfungen durch:

- Der Durchlaufhahn für Wasser ist geöffnet.
- Der Filter für den Wassereinlauf ist nicht verstopft.
- Der Druck des Leitungswassers beträgt zwischen 2/4 Kg/cm² (28/56 psi).
- Bei starken Vibrationen der Waschmaschine prüfen Sie bitte, ob alle Schrauben an den Panelen ordnungsgemäß angezogen sind.
- Die Spannungsversorgung ist unterbrochen: Das Wasser wird aus der Trommel abgelassen, aber die Gerätetür lässt sich nicht öffnen. Wenn die Wäsche der Waschmaschine entnommen werden soll, kann die Tür durch Ziehen des an der Frontblende befindlichen Bandes entriegelt werden.

5.2 Hinweise

Alle Hinweise und Fehler werden auf dem Bildschirm angezeigt. Gleichzeitig ertönt ein akustisches Signal. Bei Auftreten eines Fehlers werden die Informationen zu Programmphase und Zustand gespeichert, um genau zu wissen, an welcher Stelle im Programm der Fehler aufgetreten ist.

Die folgenden Hinweise können an der Waschmaschine auftreten:

BESCHREIBUNG	URSACHE UND ABHILFE
GERÄTETÜR OFFEN	Steht die Gerätetür zu Beginn eines Programms offen, so erscheint auf dem Bildschirm der Hinweis „GERÄTETÜR OFFEN“. 30 Sekunden lang ertönt ein Pfeifton, der dann verstummt. In diesem Fall ist nur die Option „OK“ verfügbar. Das Programm wird nicht gestartet und der Anwender kann es erneut probieren.
WASSER IN TROMMEL	Beträgt der Wasserstand bei Beendigung des Programms nicht 0 mm, so erscheint die MELDUNG „WASSER IN TROMMEL“ auf dem Bildschirm. Dem Anwender werden 2 Optionen geboten: „Fortsetzen“ oder „Beenden“. Wird „Fortsetzen“ gedrückt, so prüft das Gerät erneut, ob der Wasserstand 0 mm beträgt. In diesem Fall wird die Gerätetür entriegelt, es sei denn, dass der Fehler erneut auftritt. Wird „Beenden“ gedrückt, so wird das Programm beendet und die Gerätetür entriegelt.
KEINE KOMMUNIKATION DER KARTEN UNTEREINANDER	Im Kundendienst-Menü im Abschnitt „Bausätze Extra“ wird dieser Hinweis ausgegeben, wenn keine Kommunikation zwischen der Karte für die Hauptsteuerung und der Hilfskarte festgestellt werden kann. Die aktiven Bausätze ohne Kommunikation der Karten untereinander können deaktiviert werden. Eine Aktivierung dagegen ist nicht möglich.
TANKS VOLL (T1/T2/T3)	Dieser Hinweis wird ausgegeben, wenn der Tank Tx während eines Abflussvorgangs aktiv ist und feststellt, dass der Eingang „Pegel max. Tank x“ aktiviert ist. Das Wasser Ablassen nach Tx wird unterbrochen und das System wechselt in den normalen Ablass D1. 10 Sekunden lang ist ein Pfeifton zu hören. Der Hinweis erlöscht nach Drücken von OK oder nach Ablauf der entsprechenden Zeit.

TANKS LEER (T1/T2/T3)	Dieser Hinweis wird ausgegeben, wenn der Tank Tx während eines Füllvorgangs aktiv ist und feststellt, dass der Eingang „Pegel min. Tank x“ aktiviert ist. Der Füllvorgang von Tx wird nicht fortgesetzt und das System wechselt in den Füllvorgang mit normalem Kaltwasser. 10 Sekunden lang ist ein Pfeifton zu hören. Der Hinweis erlischt nach Drücken von OK oder nach Ablauf der entsprechenden Zeit.
KEINE KOMMUNIKATION MIT WÄGESATZ	Dieser Hinweis wird ausgegeben, wenn bei Aktivierung des Wägesatzes oder Durchführung einer Kalibrierung die Hilfskarte zwar angeschlossen ist und ordnungsgemäß funktioniert, aber keine Verbindung zum Wägegerät herstellen kann. Es ist weder möglich, den Bausatz zu aktivieren noch kann die Kalibrierung durchgeführt werden.
KALIBRIERUNG DER WÄGUNG – LEERES GERÄT SICHERN	Dieser Hinweis wird ausgegeben, wenn die Kalibrierung des Wägesatzes angelaufen ist, um den Anwender darauf hinzuweisen, dass die Waschmaschine leer sein muss, sich keine Gegenstände auf dem Gerät befinden dürfen, usw., bevor die Kalibrierung gestartet werden kann. Keine. Rein informativer Hinweis. OK-Taste drücken, um den Hinweis zu bestätigen und die Kalibrierung anlaufen zu lassen.
KALIBRIERUNG DER WÄGUNG – VORGANG LÄUFT	Dieser Hinweis wird ausgegeben, während die Kalibrierung des Wägesystems abläuft. Keine. Rein informativer Hinweis. In diesem Fall ist keine Taste verfügbar und der Hinweis wird 5 Sekunden lang angezeigt, während die Kalibrierung abläuft.
KALIBRIERUNG DER WÄGUNG – KALIBRIERUNG FEHLERHAFT	Dieser Hinweis wird ausgegeben, wenn das Wägesystem bei Beendigung des Kalibriervorgangs nicht ordnungsgemäß auf Null gesetzt werden konnte. Keine. Rein informativer Hinweis. OK-Taste zum Bestätigen des Hinweises.
KALIBRIERUNG DER WÄGUNG – KALIBRIERUNG ERFORDERLICH	Dieser Hinweis wird ausgegeben, wenn bei Drücken der Start-Taste zur Ausführung eines Waschprogramms ein Gewicht von weniger als -3 kg oder von mehr als 10 kg oberhalb des Nennwertes festgestellt wird. Dem Anwender werden zwei Optionen geboten: „Abbrechen“ oder „OK“. Nach Drücken von „OK“ wird das Programm mit dem Nenngewicht fortgesetzt. Bei Drücken der Taste „Abbrechen“ wird das Programm gestoppt.
EASY LOAD – VORGANG STARTEN	Dieser Hinweis wird nach Drücken der Taste für Easy Load auf dem Hauptbildschirm ausgegeben. Der Anwender wird darauf hingewiesen, die Wäsche einzugeben und die Gerätetür zu schließen. Anschließend wird er gefragt, ob der Easy-Load-Zyklus gestartet werden soll. Dem Anwender werden zwei Optionen geboten: „Abbrechen“ oder „OK“. Bei Drücken der Taste „Abbrechen“ wird der Easy-Load-Zyklus gestoppt und es erfolgt die Rückkehr zum Auswahlbildschirm. Nach Drücken von „OK“ wird der Easy-Load-Zyklus gestartet.
EASY LOAD – ZYKLUS LÄUFT	Dieser Hinweis wird ausgegeben, während der Easy-Load-Zyklus läuft und informiert den Anwender darüber, dass der Vorgang ordnungsgemäß ausgeführt wird. An dieser Stelle ist keine Taste verfügbar. Rein informativer Hinweis. Der Anwender muss an dieser Stelle abwarten, bis der Zyklus beendet wird.
LOAD DETECTION	Dieser Hinweis wird zu Beginn des Waschprogramms ausgegeben, wenn die „Intelligente Option für schwere Wäsche“ aktiviert ist. An dieser Stelle ist keine Taste verfügbar. Die Meldung hat rein informativen Charakter. Dieser Vorgang kann einige Minuten dauern.

Die folgenden Fehler können an der Waschmaschine auftreten:

FEHLER	BESCHREIBUNG	URSACHE UND ABHILFE
E1	UNTERBRECHUNG DER SPANNUNGSVERSORGUNG	Dieser Fehler wird eingeblendet, wenn die Spannungsversorgung nach einer Unterbrechung während der Programmausführung wieder hergestellt wird. Das Gerät setzt das Programm in diesem Fall automatisch an der Stelle fort, an der die Unterbrechung erfolgt ist, und blendet 30 Sekunden lang einen entsprechenden Hinweis ein. Dem Anwender werden die Optionen „Fortsetzen“ oder „Beenden“ geboten. Wird die Option „Fortsetzen“ gedrückt, so wird das Programm in der Phase fortgesetzt, in der die Unterbrechung der Spannungsversorgung aufgetreten ist. Die Fortsetzung erfolgt am Anfang der jeweiligen Programmphase. Wird dagegen die Option „Beenden“ gedrückt, so wird das Programm beendet und die Gerätetür entriegelt.
E2	FEHLER BEI SPERRE	Dieser Fehler wird bei Programmstart eingeblendet, wenn die Gerätetür bei Programmausführung nicht ordnungsgemäß geöffnet bzw. geschlossen werden kann. Das Programm wird beendet, so dass der Anwender sicherstellen kann, dass die Gerätetür ordnungsgemäß verschlossen ist, bevor er es erneut versucht. Sollte der Fehler fort bestehen, setzen Sie sich bitte mit dem zuständigen Kundendienst in Verbindung.
E3	FEHLER ABFLUSS / WASSER IN DER TROMMEL	Dieser Fehler wird eingeblendet, wenn die Waschmaschine das Wasser aus der Trommel nicht ablassen kann. Dem Anwender werden in diesem Fall die Optionen „Fortsetzen“ oder „Beenden“ geboten. Sicherstellen, dass die Abfluss nicht verstopft ist. Sollte das Gerät mit einer Ablasspumpe ausgerüstet sein, den Filter reinigen.
E4	HÖCHSTWASSERSTAND ERREICHT	Dieser Fehler wird eingeblendet, wenn die Waschmaschine einen zu hohen Wasserstand feststellt. Sicherstellen, dass bei im Ruhezustand befindlicher Waschmaschine kein Wasser eingefüllt wird. Anderenfalls wenden Sie sich bitte an den zuständigen Kundendienst.
E5	FEHLER WASSEREINLASS	Dieser Fehler wird eingeblendet, wenn die Waschmaschine feststellt, dass kein Wasser eingefüllt wird. Bitte führen Sie folgende Überprüfungen durch, bevor Sie sich an den Kundendienst wenden: Der Durchlaufhahn ist geöffnet. Die Einstellung für den Abfluss stimmt (Ventil/Pumpe).
E6	FEHLER AUFHEIZEN	Dieser Fehler wird eingeblendet, wenn die Waschmaschine das Wasser nicht ordnungsgemäß aufheizen kann. Überprüfen Sie bitte die richtige Einstellung für den Aufheizvorgang, bevor Sie sich an den Kundendienst wenden.
E7	HÖCHSTTEMPERATUR ÜBERSCHRITTEN	Dieser Fehler wird eingeblendet, wenn eine zu hohe Temperatur festgestellt wird. In diesem Fall wird nur die Option „Beenden“ angeboten. Das Programm wird nach Drücken dieser Option beendet, sobald die Temperatur auf einen Wert von weniger als 50° abgesunken ist. Andernfalls wird der Fehler E11 ausgegeben: WÄSCHE HEISS
E8	BEWEGUNGSFEHLER	Dieser Fehler wird eingeblendet, wenn die Waschmaschine keine Bewegung feststellt. Der Hinweis „Das Programm wird beendet“ erscheint und nach Ablauf von 2 Minuten wird die OK-Taste eingeblendet, so dass das Programm beendet werden kann.

E9	UNWUCHT	Dieser Fehler wird eingeblendet, wenn die Waschmaschine die Wäsche nicht gleichmäßig verteilen kann. Verteilen Sie die Wäsche gleichmäßiger in der Trommel.
E10	MAXIMALE UNWUCHT	Dieser Fehler wird eingeblendet, wenn die Waschmaschine zu heftige Bewegungen beim Schleudern feststellt. Sollte dieser Fehler wiederholt auftreten, so wenden Sie sich bitte an den zuständigen Kundendienst, da die Ursache des Problems möglicherweise auf die Installation und/oder Dämpfung zurückzuführen ist.
E11	WÄSCHE HEISS	Dieser Fehler wird eingeblendet, wenn die Temperatur in der Trommel bei Programmende 50°C (122°F) übersteigt. Abwarten, bis die Temperatur auf einen Wert von unter 50°C (122°F) absinkt, so dass das Programm automatisch beendet werden kann.
E12	FEHLER ENTRIEGELUNG	Dieser Fehler wird eingeblendet, wenn die Waschmaschine die Gerätetür bei Programmende nicht öffnen kann. Zu diesem Fehler kommt es nach 3 erfolglosen Entriegelungsversuchen. Diese werden alle 20 Sekunden durchgeführt. In diesem Fall ist nur die Option „Beenden“ verfügbar. Nach Auswahl dieser Option kann ein erneuter Versuch durchgeführt werden. Klappt es weiterhin nicht, wird der entsprechende Fehler weiter ausgegeben. Die Gerätetür nicht mit Gewalt bedienen, sondern den zuständigen Kundendienst benachrichtigen, damit dieser Ihnen beim sicheren Öffnen der Tür behilflich sein kann.
E23	WÄGEFEHLER	Dieser Fehler wird eingeblendet, wenn die Waschmaschine einen Kommunikationsfehler zur Wiegevorrichtung feststellt. Wenden Sie sich an den zuständigen Kundendienst. Dem Anwender werden die beiden Optionen „OK“ oder „Abbrechen“ angeboten. Durch Drücken von „Abbrechen“ wird die Ausführung gestoppt und es erfolgt die Rückkehr zum Auswahlbildschirm. Nach Drücken der OK-Taste wird die Ausführung des Programms mit dem Nenngewichtswert des Gerätes fortgesetzt.
E25	KOMMUNIKATIONSFEHLER ZWISCHEN STEUERUNG UND HILFSSTEUERUNG	Dieser Fehler wird eingeblendet, wenn die Waschmaschine einen Kommunikationsfehler zur Hilfskarte feststellt, die bei verschiedenen Zubehören zum Einsatz kommt. Wenden Sie sich an den zuständigen Kundendienst. Dem Anwender werden die beiden Optionen „OK“ oder „Abbrechen“ angeboten. Durch Drücken von „Abbrechen“ wird die Ausführung gestoppt und es erfolgt die Rückkehr zum Auswahlbildschirm. „OK“ drücken, um die Programmausführung fortzusetzen und die Funktion des jeweiligen Zubehörs zu ignorieren.
E26	FEHLER WÄRMESCHUTZSCHALTER MOTOR	Dieser Fehler wird eingeblendet, wenn die Waschmaschine eine zu hohe Temperatur am Motor feststellt. Wenden Sie sich an den zuständigen Kundendienst.
E27	FEHLER NTC AUSSERHALB DES BEREICHS	Dieser Fehler wird eingeblendet, wenn die Waschmaschine eine außerhalb des Bereichs befindliche Temperatur feststellt. Der Temperatursensor ist ausgeschaltet oder beschädigt. Wenden Sie sich an den zuständigen Kundendienst. Dem Anwender werden 2 Optionen geboten: „OK“ oder „Abbrechen“. „OK“ drücken, um das Programm fortzusetzen und den Aufheizvorgang zu ignorieren und „Abbrechen“ drücken, um das Programm zu beenden.
E28	FEHLER DRUCKSENSOR AUSSERHALB DES BEREICHS	Dieser Fehler wird eingeblendet, wenn die Waschmaschine einen außerhalb des Bereichs befindlichen Wasserstand feststellt. Der Drucksensor ist ausgeschaltet oder beschädigt. Wenden Sie sich an den zuständigen Kundendienst. Im Falle dieses Fehlers wird dem Bediener keine Taste angeboten. Es besteht lediglich die Möglichkeit, den laufenden Vorgang durch Ausschalten des Gerätes zu unterbrechen.

SELF SERVICE V2.0

6	EINLEITUNG	37
7	SCHNITTSTELLE	37
7.1	Auswahlbildschirm 1 - Tasten	37
7.2	Auswahlbildschirm 2 - Bezahlung.....	38
7.3	Münzimpulse und "Credit mode"	39
7.4	Ausführungsbildschirm.....	39
8	PROGRAMME	40
8.1	Programm-Bibliothek.....	40
9	EINSTELLUNG	41
9.1	Programmverwaltung	41
9.2	System einstellen.....	41
9.2.1	Fortgeschrittene Einstellung	41
9.2.2	HUD-Programmierung	48
9.2.3	Tabelle mit den verschiedenen Währungen.....	50
10	WARTUNG	52
10.1	Fehler	52

6 EINLEITUNG

Dieser Abschnitt beschreibt die Eigenschaften, die ausschließlich den Waschmaschinen mit Selbstbedienung vorbehalten sind. Die Sicherheitshinweise müssen gründlich gelesen und verstanden worden sein. Gleiches gilt für das gesamte restliche Handbuch, da nur so die Funktionsweise der Geräte vollständig verstanden werden kann.

7 SCHNITTSTELLE

7.1 Auswahlbildschirm 1 - Tasten

Sobald das Gerät mit Spannung versorgt wird, erscheint der *Auswahlbildschirm 1*. Die 4 auf diesem Bildschirm befindlichen großen Tasten dienen zur Auswahl der Waschprogramme.

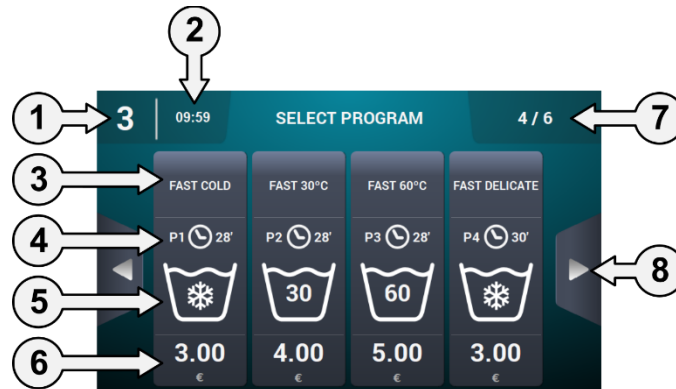

1. **Gerätekennezeichner:** Die Angabe zur Kennzeichnung des Gerätes auf Grundlage der vorhandenen Einstellung wird eingeblendet (falls die entsprechende Funktion aktiviert ist).
2. **Uhrzeit:** Die aktuelle Uhrzeit wird in dem vom Anwender ausgewählten Format angezeigt.
3. **Programmname:** Für das ausgewählte Programm eingestellter Name.
4. **Programmdauer:** Geschätzte Dauer in Minuten für das ausgewählte Programm.
5. **Programmtemperatur:** Höchsttemperatur zwischen den verschiedenen zum Programm gehörenden Phasen.
6. **Preis:** Nur im Modus Coin wird der Preis bei CP und CR nicht angegeben. Stattdessen leuchtet eine LED.
7. **Anzahl Programme:** Hier werden die Anzahl der angezeigten Programme, sowie die Anzahl der verfügbaren Programme eingeblendet. Auf dem Bildschirm werden bis zu 4 Programme angezeigt. Die maximal mögliche Anzahl anzuzeigender Programme beträgt somit 16 (4 Bildschirme mit 4 Tasten).
8. **Seitliche Navigationspfeile:** Enthält die Favoritenliste mehr als 4 Programme, so werden die seitlichen Navigationspfeile eingeblendet, um auf den jeweils nächsten Auswahlbildschirm zugreifen zu können.

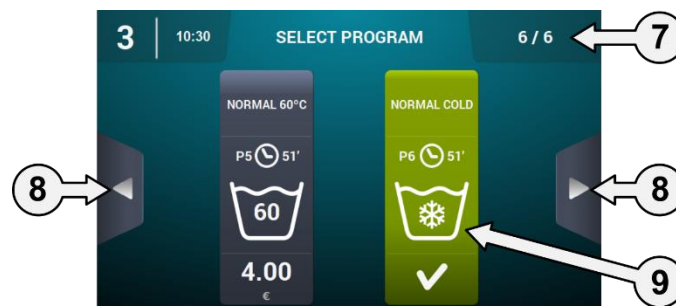

9. **Aktiviert Taste:** Auf der ersten Bildschirmmaske kann die Zahlung vorgenommen werden. Sobald der jeweilige Betrag eines Programms erreicht wird, wird der Preis ausgeblendet und die Farbe der Taste ändert sich und zeigt an, dass das Programm nun zur Ausführung freigegeben ist.

Nach Drücken einer Programmtaste erfolgt der Zugang zum *Auswahlbildschirm 2 – Bezahlung*.

Nach Beendigung der jeweiligen Programmausführung erfolgt automatisch der Wechsel zu diesem Bildschirm.

Das Gerät kehrt ebenfalls selbständig zu diesem Bildschirm zurück, wenn 15 Minuten lang keine Aktion ausgeführt worden ist, wenn bereits Münzen eingeworfen worden sind oder der Kunde den Bildschirm berührt hat. Der bereits eingeworfene Betrag wird zurückgesetzt.

7.2 Auswahlbildschirm 2 - Bezahlung

Auf diesem Bildschirm wird dieselbe Information wie auch auf der vorherigen Bildschirmmaske angezeigt. Der Unterschied besteht darin, dass die Information nur zu dem jeweils angewählten Programm zusammen mit verschiedenen Animationen und Hilfetexten angezeigt wird. Zusätzlich werden zwei Navigationstasten eingeblendet, um das Programm wechseln zu können.

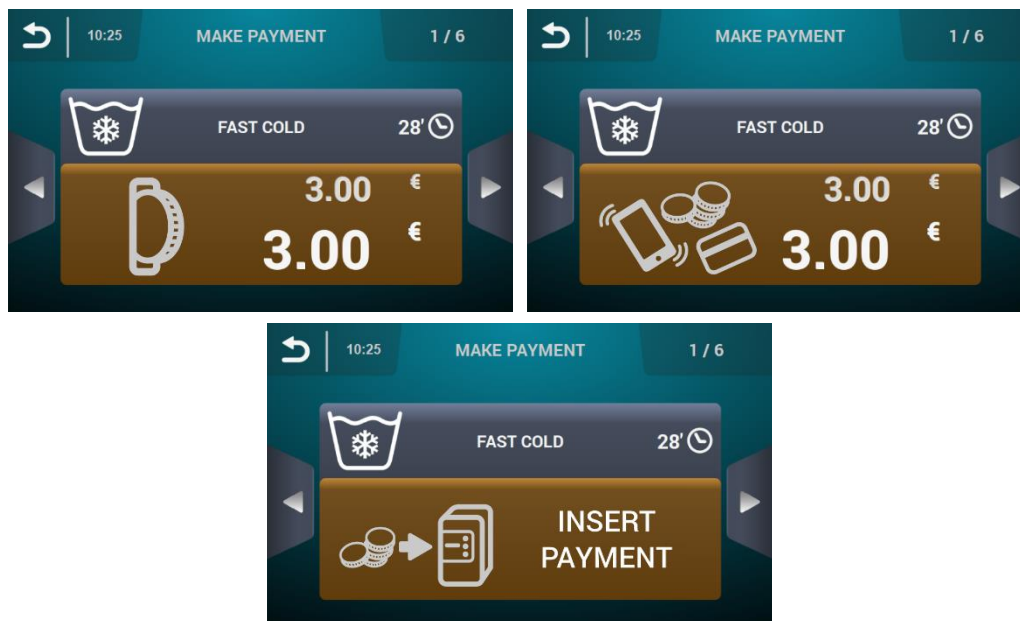

So lange der für das Programm angegebene Betrag nicht eingegeben wird, erscheint die Taste in braun.

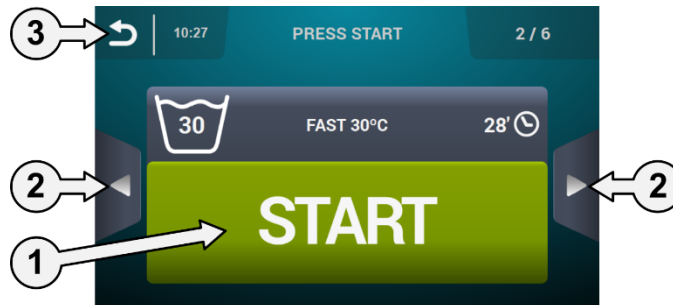

1. **Start-Taste:** Sobald der dem Programm entsprechende Betrag erreicht wird, erscheint die große Start-Taste in grün.
2. **Navigationstasten:** Diese Tasten ermöglichen Programmwechsel.
3. **Taste „Zurück“:** Nach Drücken dieser Taste erfolgt die Rückkehr zum Hauptbildschirm „Auswahl 1 – Tasten“.

Sollte innerhalb von 15 Minuten keine Aktivität erfolgt sein, so wird der eingeworfene Betrag zurückgesetzt und das Geld einbehalten. Anschließend wird der Bildschirm „Auswahl 1 – Tasten“ eingeblendet.

Die Ausführung des ausgewählten Programms startet nach Drücken der Start-Taste.

7.3 Münzimpulse und "Credit mode"

Zur Ausführung eines Programms muss zunächst die entsprechende Zahlung geleistet werden. Dazu werden je nach vorhandener Einstellung der Selbstbedienung der Münzeinwurf gesteuert (Modus COIN) oder das entsprechende Signal im Modus CP bzw. Mehrfachzahlung über den Eingang „Mikroschalter Münzvorrichtung“ empfangen, um so die Ausführung des ausgewählten Programms freizugeben.

Im Selbstbedienungsmodus kann (sowohl auf Bildschirmmaske 1 als auch auf dem Bildschirm 2 zur Auswahl, ganz so als ob ein Selbstbedienungsprogramm ausgeführt wird) der Zugang zu dem „Credit Mode“ erfolgen. Wird der Eingang „Abdeckplatte geöffnet“ bei den Modellen für den Industriegebrauch aktiviert bzw. der Schlüssel der Münzvorrichtung oder CP bei den Modellen für den Profigebrauch betätigt, so bittet das System um Eingabe des Passwortes, um den Zugang zum „Credit Mode“ freizugeben.

Erfolgt der Zugang zum „Credit mode“, wird automatisch der Modus Selbstbedienung verlassen. Das Gerät verhält sich dann genauso wie im normalen Modus und zeigt die im *Hauptbildschirm OPL* festgelegten Informationen an. Es können alle auf diesem Bildschirm festgelegten Aktionen ausgeführt werden. Es werden die zur Selbstbedienung gehörenden Programme und die für den „Credit Mode“ festgelegten Programme angezeigt.

Bei Zugang zum Hauptmenü werden alle für die Selbstbedienungswaschmaschinen verfügbaren Optionen angezeigt.

Wird der Eingang „Abdeckplatte geöffnet“ bei den Modellen für den Industriegebrauch deaktiviert bzw. der Schlüssel der Münzvorrichtung oder CP bei den Modellen für den Profigebrauch abgezogen, so wird der „Credit Mode“ automatisch verlassen. Befindet sich der Kunde auf einem Unterbildschirm des Hauptmenüs (Einstellung, Wartung, usw.) und verlässt er den „Credit Mode“, so verhält sich das System so, als ob es sich in diesem Modus befinden würde, bis der Wechsel zum Hauptmenü erfolgt (die Änderungen werden gespeichert). Vom Hauptbildschirm aus wird der „Credit Mode“ verlassen.

7.4 Ausführungsbildschirm

Das Programm startet nach Drücken der START-Taste und der *Ausführungsbildschirm* wird eingeblendet.

Bei laufendem Gerät besteht außerdem die Möglichkeit, auf die gleiche Art und Weise wie zuvor beschrieben auf den „Credit Mode“ zuzugreifen. Erfolgt der Zugang in diesem Modus, wird automatisch der Modus Selbstbedienung verlassen. Das Gerät verhält sich dann genauso wie im OPL-Modus und zeigt die im *Ausführungsbildschirm* festgelegten Informationen an. Es können alle auf diesem Bildschirm festgelegten Aktionen ausgeführt werden.

Im Modus Selbstbedienung ist keine Option zum Vorspringen im Programm oder zum Unterbrechen des Programms vorgesehen, es sei denn, dass der Kunde sich im „Credit Mode“ befindet.

Defaultmäßig ist die STOP-Taste zum Abbruch des Programms ebenfalls nicht verfügbar. Allerdings kann diese über den HUD aktiviert werden.

Nach Drücken der STOP-Taste wird eine kurze Schonfrist gewährt, in der das Programm abgebrochen werden kann, ohne dass das eingeworfene Geld einbehalten wird. Wird das Programm allerdings innerhalb der Schonfrist zum zweiten mal abgebrochen, so wird das Geld einbehalten.

Nach Ablauf der Schonfrist muss die entsprechende Taste mindestens 3 Sekunden lang gedrückt werden, um das Programm abbrechen zu können. Das Geld wird in diesem Fall einbehalten.

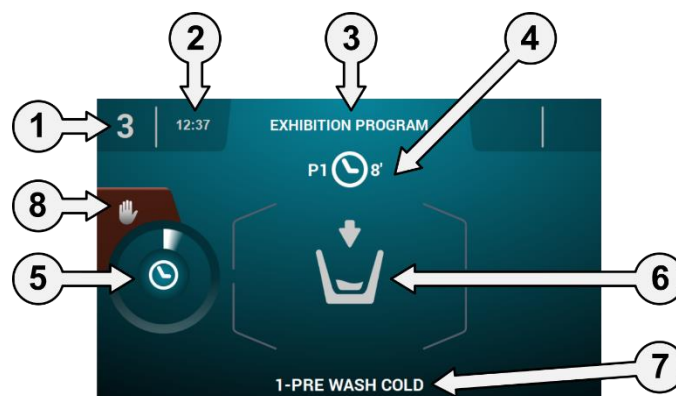

1. **Gerätekennzeichner:** Angabe zur Kennzeichnung des Gerätes.
2. **Uhrzeit:** Stunden und Minuten im ausgewählten Format.
3. **Programmname:** Für das ausgewählte Programm eingestellter Name.
4. **Programmnummer und -dauer:** Stellung des Programms in der Programmliste (Meine Programme) und die ungefähre Dauer des ausgewählten Programms in Minuten.
5. **Fortschrittsanzeige für das Programm:** Programmfortschritt, Beziehung zwischen Gesamtdauer und Restzeit des Programms.
6. **Zustand (Symbol):** Symbol zur Anzeige der gerade in Ausführung befindlichen Phase der Waschmaschine (Füllvorgang, Entleeren, Waschen, Klarspülen, Schleudern oder Auflockern).
7. **In Ausführung befindliche Phase:** Kennzeichner und Name der in Ausführung befindlichen Programmphase.
8. **Stop:** (defaultmäßig nicht freigegeben): Taste zum Abbrechen des Programms. In diesem Fall fordert das System eine Bestätigung an.

8 PROGRAMME

Das System verfügt über eine Bibliothek mit allen defaultmäßig vorhandenen Programmen, sowie den vom Anwender angelegten Programmen.

8.1 Programm-Bibliothek

Die folgenden Programme sind defaultmäßig in der Programm-Bibliothek enthalten:

- P1: Schnelles Kaltwaschen
- P2: Schnellwäsche 30°C (86°F)
- P3: Schnellwäsche 60°C (140°F)
- P4: Schnelle Feinwäsche

P1						P2					
	8	2	2	2	6		8	2	2	2	6
							30				
	1	3	3	3			1	3	3	3	
	3	3	3	3	4		3	3	3	3	4
	0	0	0	0			1	0	0	0	
	15;05	15;05	15;05	15;05			15;05	15;05	15;05	15;05	
	✓	✓	✓	✓			✓	✓	✓	✓	
	✓	✓	✓	✓			✓	✓	✓	✓	
	✓	✓	✓	✓			✓	✓	✓	✓	
					✓						✓
					✓						✓
D	D2, D3			D4, D5		D	D2, D3			D4, D5	

P3	60	1	2	3	
	8	2	2	2	6
	60				
	1	3	3	3	
	3	3	3	3	4
	1	0	0	0	
	15;05	15;05	15;05	15;05	
	✓	✓	✓	✓	
	✓	✓	✓	✓	
	✓	✓	✓	✓	
					✓
					✓
D	D2, D3			D4, D5	

P4		1	2	3	
	8	2	2	2	6
	2	4	4	4	
	2	2	2	2	3
	0	0	0	0	
	08;06	08;06	08;06	08;06	
	✓	✓	✓	✓	
	✓	✓	✓	✓	
	✓	✓	✓	✓	
					✓
					✓
D	D2, D3			D4, D5	

9 EINSTELLUNG

9.1 Programmverwaltung

Ist die Waschmaschine auf den Modus Selbstbedienung eingestellt, so sind nur die ersten 6 Programme verfügbar. Alle weiteren Programme sind verfügbar sobald in den „Credit Mode“ gewechselt wird.

9.2 System einstellen

9.2.1 Fortgeschrittene Einstellung

Zugang: [Hauptbildschirm] ⇒ [Hauptmenü]

In der Systemeinstellung kann die Einstellung der folgenden Bereiche genauso wie im „Credit Mode“ vorgenommen werden (siehe Abschnitt 4.2):

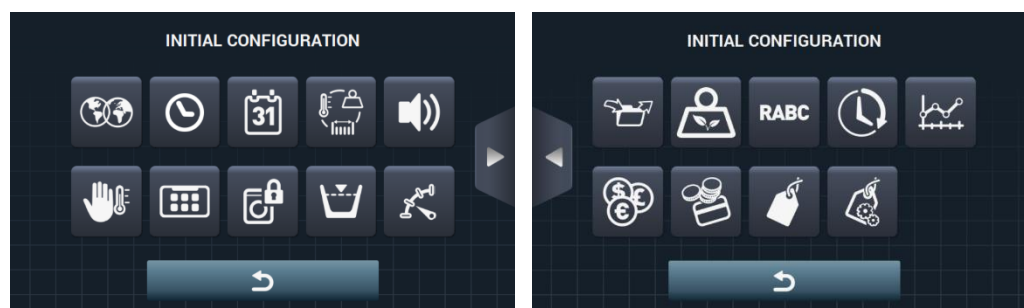

- **Nächster Bildschirm.**
- **Vorheriger Bildschirm.**
- **Sprache:** Die Anzeigetexte der Waschmaschine können in 34 verschiedenen Sprachen angezeigt werden. Die Bearbeitung dieser Texte kann allerdings nur mit westlichen Schriftzeichen erfolgen.

- 
Uhrzeit: Einstellen der aktuellen Uhrzeit. Das angezeigte Format kann ausgewählt werden (12 Stunden / 24 Stunden (defaultmäßige Einstellung)).
- 
Datum: Einstellen des aktuellen Datums. Das angezeigte Format kann ausgewählt werden (dd/mm/yyyy (defaultmäßige Einstellung) / yyyy/mm/dd / mm/dd/yyyy).
- 
Maßeinheiten: Hier kann die gewünschte Maßeinheit zur Anzeige der Temperatur (°C (defaultmäßige Einstellung) bzw. °F), des Gewichts (kg (defaultmäßige Einstellung) bzw. Lb) und die Größe (mm (defaultmäßige Einstellung) bzw. in) ausgewählt werden.
- 
Thermo-Stillstand: Allgemeine Einstellung des Thermo-Stillstands. Ist diese Funktion ausgeschaltet, so erfolgt kein Thermo-Stillstand. Es erfolgt auch dann kein Thermo-Stillstand, wenn dieser Parameter in der in Ausführung befindlichen Phase ausgewählt ist. Ist diese Funktion dagegen eingeschaltet, so wird die Einstellung der verschiedenen Phasen unverändert gelassen und entsprechend angewandt. Defaultmäßige Einstellung: eingeschaltet.
- 
Wassereinsparung bei schwerer Wäsche: Die gewünschte Wassereinsparung für schwere Wäsche kann bedarfsgerecht eingestellt werden. Hierzu kann zwischen 3 folgenden verschiedenen Optionen und 3 Einsparstufen gewählt werden.
Je nach Trommelfüllung erfolgt die entsprechende Senkung des Wasserstands und der Dosierung an Waschmittel.
- 
Wasserstände: Hier können die 5 einstellbaren Wasserstände in mm eingestellt werden. Jedem dieser Wasserstände sind ein defaultmäßiger Wert und ein Einstellbereich zugeordnet. Diese Werte sind je nach ausgewähltem Modell unterschiedlich. (Siehe die Tabelle der Wasserstände für die verschiedenen Modelle).
- 
Geschwindigkeit: Hier können die verschiedenen verfügbaren Geschwindigkeiten sowohl zum Waschen als auch zum Schleudern in UPM eingestellt werden. Jeder Geschwindigkeit sind ein Mindest- bzw. Höchstwert für die Einstellung zugeordnet. (Siehe die Tabelle der Entsprechungen UpM/V für die verschiedenen Modelle).
- 
Einstellung importieren bzw. exportieren: Hier kann eine Maschineneinstellung von einem USB-Speicher importiert bzw. eine aktuelle Maschineneinstellung auf einen USB-Speicher exportiert werden. Nach Drücken dieser Taste erscheint ein Übergangsbildschirm, der die Auswahl zwischen Importieren und Exportieren ermöglicht (wie auch bei den Programmen).
- 
Credit Mode: Befindet sich die Waschmaschine im Modus Selbstbedienung, so kann das Passwort für den „Credit Mode“ geändert werden (defaultmäßig: 1234). Notieren Sie das neue Passwort und bewahren es gut auf. Sollten Sie es verlieren, wenden Sie sich bitte an den zuständigen Kundendienst.
- 
HUD: Im Selbstbedienungsmodus können außerdem der *Hauptbildschirm* (die erste Bildschirmmaske und der zweite Auswahlbildschirm), sowie der *Ausführungsbildschirm* eingestellt werden. (siehe Abschnitt 9.2.2).
- 
Beep: Diese Option dient zum Ausschalten des Summers. Defaultmäßige Einstellung: eingeschaltet.
- 
RABC/Rückverfolgbarkeit: Folgende Informationen zu jedem Waschvorgang werden gespeichert (siehe Abschnitt 4.2).
- 
Schonfrist: Nach Drücken dieser Taste wird ein Übergangsbildschirm eingeblendet, auf dem die Schonfrist aktiviert bzw. deaktiviert werden kann. Der entsprechende Wert kann zwischen 1 und 99 Minuten eingestellt werden (defaultmäßig ist die Schonfrist eingeschaltet und auf 1 Minute eingestellt).

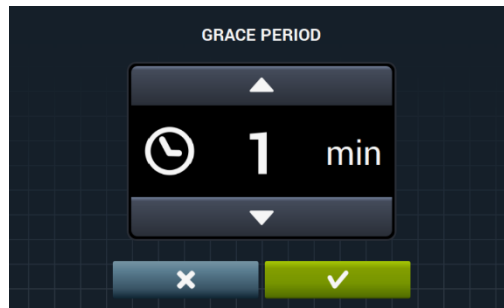
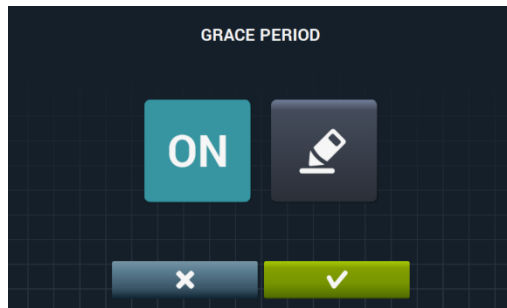

- 
Statistiken - Selbstbedienung: Hier können die Angaben zur Geldeinnahme und die Anzahl der Ausführungen der verschiedenen Programme aus der Favoritenliste erfasst werden. Nach Drücken der Taste für die Statistiken in der **Selbstbedienung** wird der folgende Bildschirm eingeblendet.

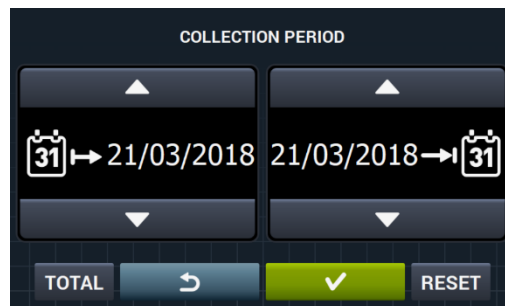

Nach Drücken der Anzeige TOTAL werden die Gesamtwerte des Gerätes angezeigt. Nach Eingabe eines Datums werden ausschließlich die zu diesem Zeitraum gehörenden Statistiken angezeigt. Nach Drücken von „Reset“ werden alle Werte auf Null gesetzt und die Statistiken wieder zurückgesetzt.

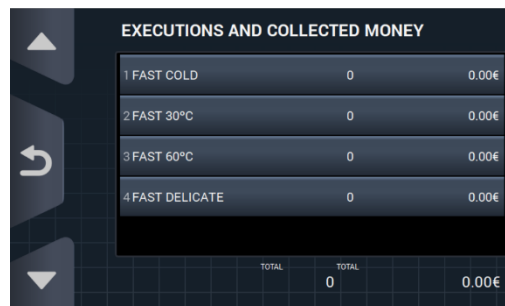



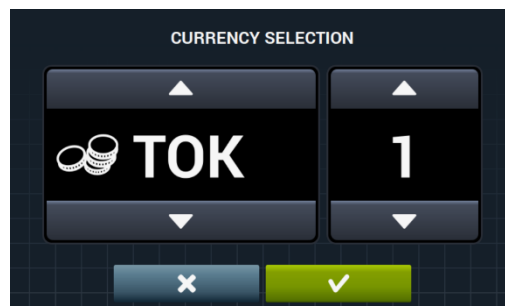

- 
Währung: Hier kann die Währung ausgewählt werden, mit der das Gerät arbeiten soll. Außerdem kann hier der Impulswert geändert werden (siehe Abschnitt 9.2.3). Wird die Währung geändert, so werden aller Preise defaultmäßig auf „Token“ zurück gesetzt.

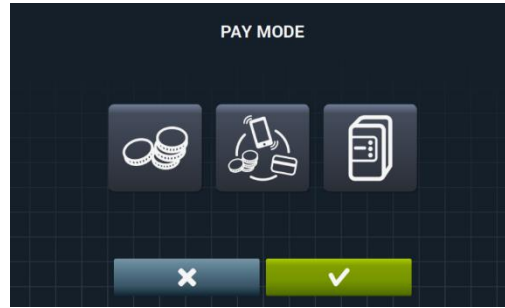



- 
Zahlweise: Es sind 3 verschiedene Modi zum Arbeiten im Modus Selbstbedienung vorgesehen.



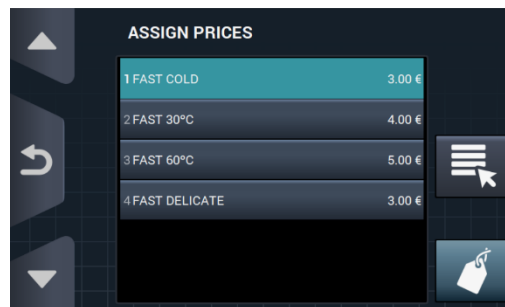

- 
COIN: Hier müssen für jedes Programm die Währung und der Preis genau eingestellt werden, damit die Münzvorrichtung die Ausführung des entsprechenden Programms freigibt.
- 
Central Payment: Die Waschmaschine erhält einen Impuls vom Zahlssystem und gibt daraufhin die Programmausführung frei. Defaultmäßige Auswahl.
- Die Optionen für Währung, Preis und Programmierung der Preise sind ausgeschaltet.
- 
Mehrfachzahlung: Die Funktionsweise ist dieselbe wie die der Option „COIN“.

- 
Preise: Die Preise aller in „Meine Programme“ ausgewählten Programme können hier eingestellt werden. Der Mindestwert des Programms ist ein in der Währung festgelegter vielfacher Wert während der Höchstwert 100 mal dem Wert dieses Vielfachen entspricht. Defaultmäßig handelt es sich um den einstellbaren Mindestwert.

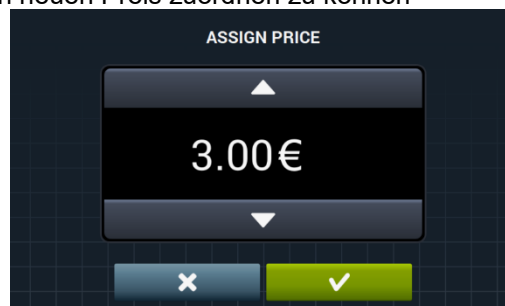

Das oder die zu ändernden Programme auswählen und die Taste  drücken, um auf dem dann eingeblendeten Bildschirm einen neuen Preis zuordnen zu können



- 
Programmierung der Preise: Zusätzlich zur Grundeinstellung der Preise besteht die Möglichkeit, die Preise zu programmieren. Dabei werden genaue Zeiträume programmiert, in denen der festgelegte Preis der Programme variieren soll. Es können höchstens 10 Programmierungen gleichzeitig vorgenommen werden.

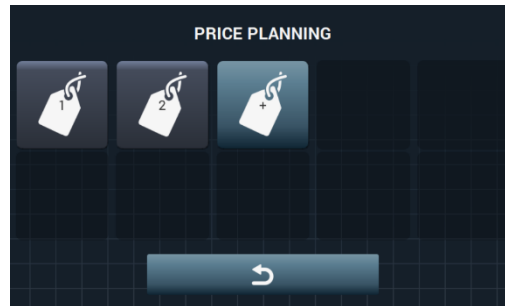

Die programmierten Preise haben eine Gültigkeit innerhalb des eingestellten Zeitfensters und kehren nach Ablauf der eingestellten Uhrzeit zu den normalen Preisen zurück.

Sollte es zu einem Konflikt zwischen verschiedenen Programmierungen kommen, so findet die Bedingung des ersten Plans Anwendung. Pläne können nur ausgehend vom aktuellen Datum angelegt werden.

Nach Drücken der Taste  wird ein neuer Plan angelegt. Die folgenden Felder müssen ausgefüllt werden, um eine neue Programmierung vorzunehmen:

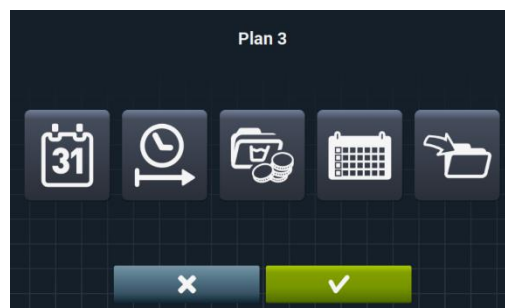

- 
Datum: Zeitraum, in dem die Programmierung erfolgen soll.

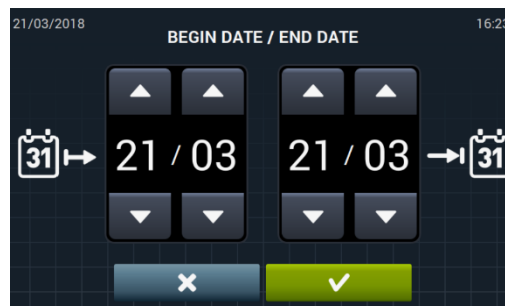

- 
Start-/ Stop-Zeit: Uhrzeit für Beginn und Ende der vorgenommenen Programmierung.

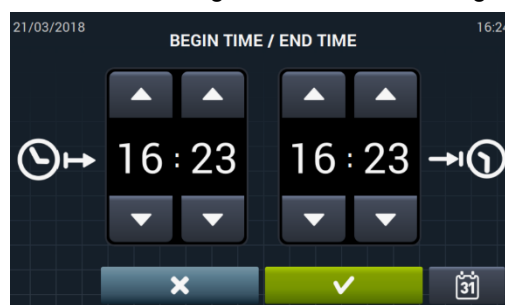

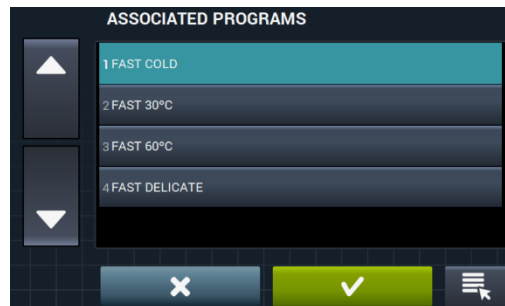

- 
Programm(e) und Preise: Preis oder Nachlass für die in „Meine Programme“ vorhandenen Programme.
 Es kann ein Festpreis zugeordnet oder ein Nachlass auf die ausgewählten Programme angewandt werden.

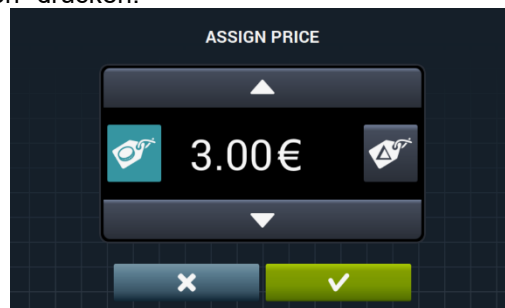

Hierzu werden das oder die Programme ausgewählt, auf die die Preisänderung Anwendung finden soll, und „Akzeptieren“ drücken.



- 
Festpreis: Der festgelegte Preis wird auf alle ausgewählten Programme angewandt.
- 
Nachlass: Der festgelegte Nachlass wird auf alle ausgewählten Programme angewandt.
- 
Kalender: Hierbei handelt es sich um konkrete Tage innerhalb des ausgewählten Datums, an denen die durchgeführte Programmierung Anwendung finden soll.

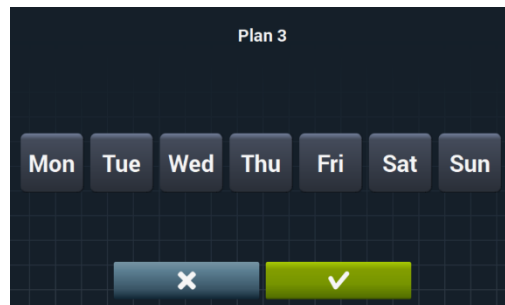

- 
Importieren: Die verschiedenen Felder können einzeln ausgefüllt werden. Es kann aber auch ein bereits vorhandener Plan von einem USB-Speicher importiert werden.

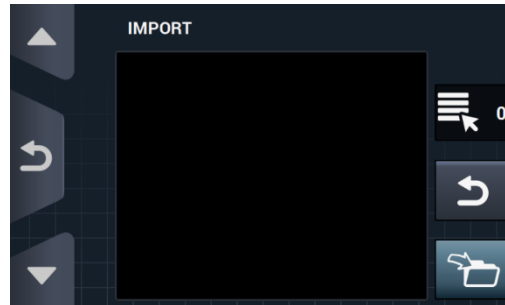

Wird die Funktion IMPORTIEREN ausgewählt, so erscheint derselbe Bildschirm wie auch bei den Programmen, die das Navigieren auf dem USB-Speicher ermöglicht. Allerdings können in diesem Fall ausschließlich Dateien von Preisplänen ausgewählt werden (Erweiterung .plan). Zum Importieren kann nur ein einziger Plan ausgewählt werden. Nach Drücken der OK-Taste und des erfolgten Imports des jeweiligen Plans erfolgt die Rückkehr zum Hauptbildschirm mit den Preisplänen.

Nach Drücken der Taste eines aktiven Plans , wird eine Zusammenfassung der eingestellten Parameter gezeigt.

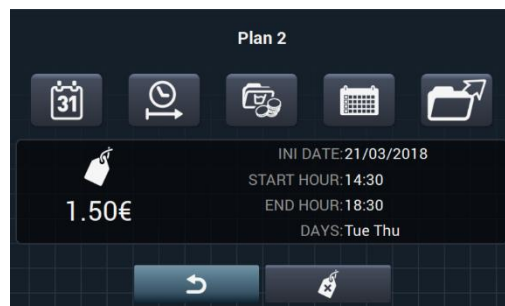

Die zuvor beschriebenen Parameter können einzeln nach Drücken der zugehörigen Taste geändert werden.

Zusätzlich ist die Taste „Exportieren“  vorgesehen, um diesen Plan dann in das Stammverzeichnis des USB-Speichers exportieren zu können (in einer Datei mit der Erweiterung .plan).

Die zu den Preisübersichten gehörenden Dateien werden in einem Verzeichnis mit dem Namen PRICE PLANS im Stammverzeichnis des USB-Speichers aufbewahrt.

Jede einzelne der zu den Preisübersichten gehörenden Dateien hat den folgenden Namen: PLAN_Nr._Datum_Uhrzeit.plan (zum Beispiel: PLAN_3_20151029_112346.plan).

Der Plan kann durch Drücken der Löschtaste  gelöscht werden.

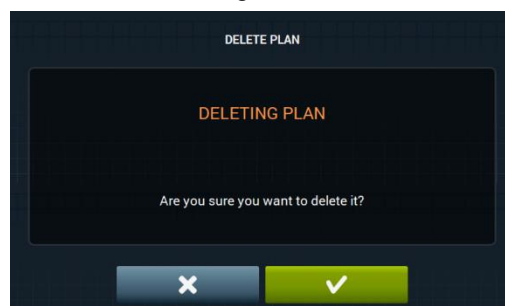

9.2.2 HUD-Programmierung

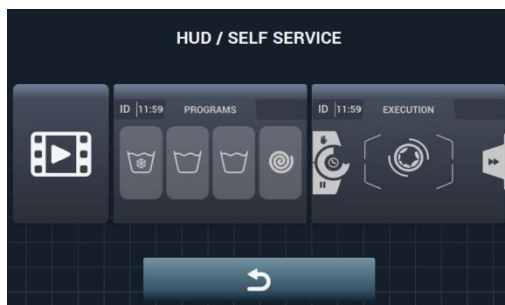

- Hauptbildschirm:** Diese Angaben sind für beide Auswahlbildschirme für die Selbstbedienung anwendbar. Hier können die folgenden Parameter eingestellt werden:

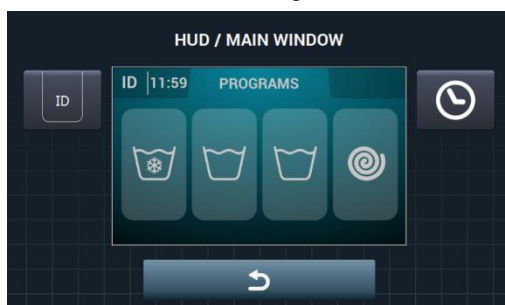

- ID** **Gerätekenzeichner:** Hier kann die Gerätekenzeichnung eingeblendet bzw. ausgeblendet und eingestellt werden. Defaultmäßige Einstellung: ausgeschaltet.

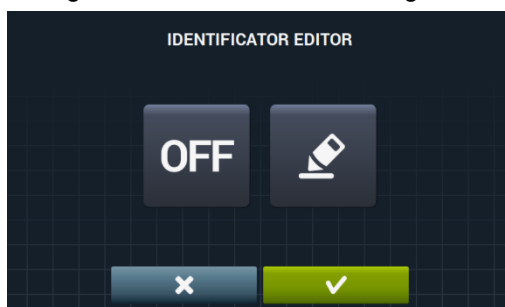



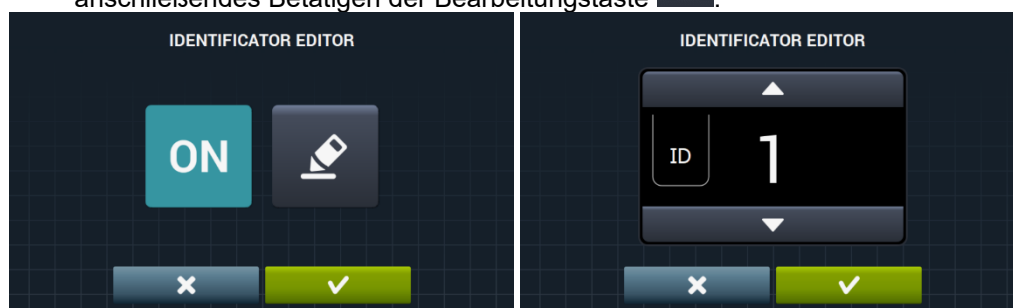

Die Aktivierung des Gerätekenzeichners erfolgt durch Drücken der Taste OFF **OFF** und anschließendes Betätigen der Bearbeitungstaste .





- Uhrzeit:** Aktuelle Uhrzeit ein- bzw. ausblenden. Defaultmäßige Einstellung: eingeblendet.

-  **Ausführungsbildschirm:** Im Folgenden werden die einstellbaren Optionen dargestellt:

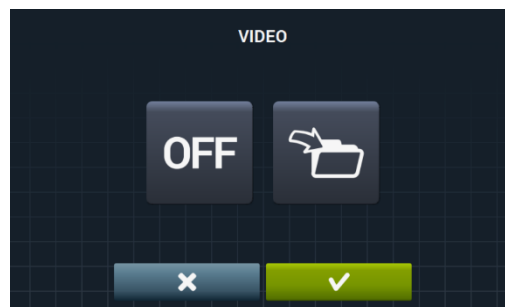

-  **Uhrzeit:** Diese Option dient zum Ein- bzw. Ausblenden der Uhrzeit. Defaultmäßige Einstellung: eingeblendet.
 -  **Restzeit:** Diese Option ermöglicht es, die gesamte Restzeit und die Fortschrittsanzeige für das Programm ein- bzw. auszublenden. Defaultmäßige Einstellung: eingeschaltet.
 -  **Gerätekenzeichner:** Hier kann die Gerätekenzeichnung eingeblendet bzw. ausgeblendet werden. Defaultmäßige Einstellung: ausgeschaltet.
 -  **STOP:** Die Taste zum Anhalten kann hier eingeblendet werden. Defaultmäßige Einstellung: ausgeschaltet.
-  **Video importieren:** Nach 10 Minuten Inaktivität kann ein Videofilm auf dem Gerätebildschirm abgespielt werden. Wird die Funktion „Energieeinsparung“ eingeschaltet, so erfolgt automatisch die Deaktivierung der Wiedergabe des Videofilms.



Nach Drücken der Importtaste , kann ein Videofilm von einem externen USB-Speicher in das Gerät importiert werden. Es können ausschließlich Videodateien (avi, mov, etc.) importiert werden und es kann nur eine einzige Videodatei in das Gerät installiert werden. Die werkseitig empfohlene Auflösung beträgt 480x272 Pixel für Geräte mit 4,3-Zoll Bildschirm und 800x480 Pixel für Geräte mit 7-Zoll Bildschirm. Der Hersteller rät davon ab, 16 Fps zu überschreiten. Die höchstzulässige Dateigröße beträgt 25 Mb.

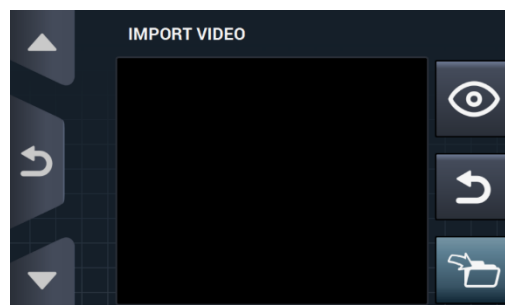

Die Vorschau-Taste dient zum Sicherstellen , dass die Videodatei ordnungsgemäß angezeigt wird.

9.2.3 Tabelle mit den verschiedenen Währungen

Diese Tabelle enthält alle verfügbaren Währungen mit dem zugehörigen Symbol und Impuls (Vielfaches). Wird ein vom defaultmäßigen Wert abweichender Impulswert ausgewählt, so muss die Münzvorrichtung an diesen Wert angepasst werden. Diese Anpassung liegt in der Verantwortung des Anwenders. Die mitgelieferten Münzvorrichtungen sind defaultmäßig auf die folgenden Werte eingestellt:

LAND	MÜNZE	ISO	SYMBOL	Wert/IMPULS	
Token	Token	TOK	\$	1	
Kuwait	Kuwaitischer Dinar	KWD	ك.د.	0,05	
Oman	Omanischer Rial	OMR	ر.ع.		
Aserbaidshjan	Manat	AZN	m	0,1	
Bulgarien	Lev	BGN	лв		
Bahrain	Bahrainischer Dinar	BHD	ب.د.		
China	Chinesischer Yuan	CNY	¥		
Malaysia	Malaysischer Ringgit	MYR1	RM		
Panama	Panamaischer Balboa	PAB	B		
Argentinien	Argentinischer Peso	ARS	\$		
Bermuda	Dollar (Bermuda)	BMD	BD\$	0,25	
Brasilien	Real	BRL	R\$		
Kanada	Dollar (Kanada)	CAD	C\$		
Ägypten	Ägyptisches Pfund	EGP	م.ج.		
Äthiopien	Äthiopischer Birr	ETB	Br		
Guatemala	Quetzal	GTQ	Q		
Cayman-Inseln	Dollar (Cayman-Inseln)	KYD	\$		
Saudi Arabien	Saudischer Rial	SAR	س.ر.		
El Salvador	Dollar (El Salvador)	SVC	¢		
Türkei	Türkische Lira	TRY	YTL		
Vereinigte Staaten	US-Dollar	USD	\$		
Vereinigte Arabische Emirate	Dirham	AED	د.إ.		
Bolivien	Boliviano	BOB	Bs		0,5
Estland	Estländische Krone	EEK	EEK		
Euro-Länder	Euro	EUR	€		
Vereinigtes Königreich	Pfund Sterling	GBP	£		
Georgien	Lari	GEL	ლარი		
Ghana	Ghanaischer Cedi	GHS	GHS		
Kroatien	Kroatischer Kuna	HRK	kn		
Neu Seeland	Dollar (Neu Seeland)	NZD	\$		
Katar	Katarischer Rial	QAR	ق.ر.		
Ukraine	Ukrainische Hrywnja	UAH	\$		
Singapur	Dollar (Singapur)	SGD	S\$		
Malaysia	Malaysischer Ringgit	MYR2	RM		

Bosnien und Herzegowina	Konvertible Mark	BAM	KM	1
Bangladesch	Bengalischer Taka	BDT	Tk	
Schweiz	Schweizer Franken	CHF	CHF	
Dominikanische Republik	Dominikanischer Peso	DOP	RD\$	
Hongkong	Dollar (Hongkong)	HKD	HK\$	
Israel	Israelischer Schekel	ILS	₪	
Indien	Indische Rupie	INR	Rs.	
Sri Lanka	Sri Lanka Rupie	LKR	₨	
Marokko	Marokkanischer Dirham	MAD	م.د.	
Mazedonien	Mazedonischer Dinar	MKD	MKD	
Peru	Peruanischer Nuevo Sol	PEN	S/.	
Polen	Polnischer Zloty	PLN	zł	
Russische Föderation	Russischer Rubel	RUB	руб	
Schweden	Schwedische Krone	SEK	kr	
Thailand	Thailändischer Baht	THB	฿	
Tunesien	Tunesischer Dinar	TND	ت.د.	
Uruguay	Uruguayscher Peso	UYU	\$	
Serbien	Serbischer Dinar	RSD	дин.	
Südafrika	Südafrikanischer Rand	ZAR	R	
Australien	Dollar (Australien)	AUD	\$	
Tschechische Republik	Tschechische Krone	CZK	Kč	5
Dänemark	Dänische Krone	DKK	kr	
Kenia	Kenianischer Schilling	KES	KSh	
Mexiko	Mexikanischer Peso	MXN	\$	
Norwegen	Norwegische Krone	NOK	kr	
Rumänien	Rumänischer Leu	RON	L	
Philippinen	Philippinischer Peso	PHP	\$	
Algerien	Algerischer Dinar	DZD	د.ج.	10
Guyana	Dollar (Guyana)	GYD	GY\$	
Ungarn	Ungarischer Florin	HUF	Ft	
Island	Isländische Krone	ISK	kr	
Kasachstan	Kasachstanischer Tenge	KZT	₸	
Taiwan	Dollar (Taiwan)	TWD	NT\$	
Chile	Chilenischer Peso	CLP	\$	
Costa Rica	Costaricanischer Colon	CRC	₡	50
Iran	Iranischer Rial	IRR		
Paraguay	Paraguayischer Guaraní	PYG	\$	
Französisch Polynesien	Franke CFP	XPF	F	
Kolumbien	Kolumbianischer Peso	COP	\$	100
Indonesien	Indonesische Rupie	IDR	Rp	
Japan	Japanischer Yen	JPY	¥	
Süd Korea	Koreanischer Won	KRW	₩	
Uganda	Uganda-Schilling	UGX	USh	
Venezuela	Bolívar	VEF	Bs.	

10 WARTUNG

10.1 Fehler

Hier werden die Fehler beschrieben, deren Beseitigungsmaßnahmen für die Selbstbedienungsgeräte unterschiedlich sind. Alle anderen sind gleich.

FEHLER	BESCHREIBUNG	URSACHE UND ABHILFE
E6	FEHLER AUFHEIZEN	Dieser Fehler tritt auf, wenn die Wassertemperatur trotz des aktivierten Ausgangs des Heizschützes nach Ablauf von 30 Minuten nicht angestiegen ist. Dieser Fehler kann unterdrückt werden. In diesem Fall wird kein Fehler ausgegeben, sondern das Programm so fortgesetzt, als ob die erforderliche Temperatur erreicht worden wäre. Es wird ein Hinweis ausgegeben, es erfolgt aber keine Unterbrechung. Der Hinweis bleibt bis zum Ende des Programms und zum Öffnen der Tür bestehen.
E9	UNWUCHT	Bei der Verteilung des abschließenden Schleuderns wird der Eingang „Schalter Unwucht“ fünf mal aktiviert. Es wird kein Fehler ausgegeben und das Schleudern erfolgt mit niedriger Geschwindigkeit. Das Programm endet normalerweise ohne Hinweise.

AVVERTENZE DI SICUREZZA	2
1 USO	5
1.1 Consigli d'uso	5
1.2 Uso del dosificador.....	5
1.3 Caratteristiche della macchin	5
2 INTERFACCE.....	6
2.1 Schermata OFF OPL	6
2.2 Schermata principale OPL	6
2.3 Schermata di esecuzione OPL.....	7
3 PROGRAMMI	10
3.1 Parametri di fase	10
3.1.1 Parametri per fasi di ammollo, prelavaggio, lavaggio o risciacquo:	10
3.1.2 Parametri per le fasi della centrifuga:.....	12
3.2 Biblioteca delle fasi	13
3.3 Biblioteca dei programmi	15
4 CONFIGURAZIONE	16
4.1 Gestione dei programmi.....	17
4.1.1 I miei programmi (preferiti).....	17
4.1.2 Biblioteca dei programmi	18
4.1.3 Biblioteca delle fasi	21
4.2 Configurare Sistema	22
4.2.1 Configurazione HUD	26
5 MANUTENZIONE	30
5.1 Anomalie elettriche e meccaniche	30
5.2 Avvisi	30

AVVERTENZE DI SICUREZZA

Per ridurre il rischio di scariche elettriche o di lesioni personali mentre si usa l'apparecchio, si raccomanda di seguire le precauzioni basilari, incluse le seguenti:

- **LEGGERE** tutte le istruzioni prima di usare l'apparecchio e **CONSERVARLE** in un luogo facilmente accessibile per risolvere qualsiasi dubbio.
- **NON** lavare capi che siano stati previamente trattati, lavati, in ammollo o macchiati di benzina o con altre sostanze infiammabili o esplosive poiché esalano dei vapori in grado di provocare incendi o esplosioni.
- **NON** aggiungere benzina, solventi per la pulizia a secco o altre sostanze infiammabili all'acqua di lavaggio. Queste sostanze sprigionano dei vapori che possono incendiarsi o esplodere.
- In determinate condizioni, il gas dell'idrogeno può essere prodotto in un sistema d'acqua calda che non è stato usato per due o più settimane. Il gas idrogeno è esplosivo. Se il sistema dell'acqua calda non è stato usato per un periodo, prima di usare di nuovo la lavatrice, aprire tutti i rubinetti dell'acqua calda e far scorrere l'acqua per alcuni minuti. Questo libererà il gas idrogeno accumulato. Poiché il gas è infiammabile, non fumare e non tentare di accendere con una fiamma durante questo periodo.
- Questo apparecchio può essere utilizzato da bambini di età compresa fra gli 8 anni e superiore e persone dalle facoltà fisiche, sensitive o cognitive ridotte o prive di esperienza e conoscenza, nel caso gli sia stata fornita la supervisione o formazione appropriata rispetto all'uso dell'apparecchio in modo sicuro e che siano in grado di comprendere i pericoli correlati. La pulizia e

manutenzione da realizzare dall'utilizzatore non può essere realizzata da minori senza supervisione.

- NON permettere ai bambini di giocare vicino o sopra l'apparecchio. Mantenere i bambini sotto stretta sorveglianza quando si trovano vicino alla macchina in funzionamento. I bambini minori di 3 anni devono essere mantenuti lontani salvo una vigilanza permanente.
- Smontare lo sportello prima di rottamare l'apparecchio o di metterlo fuori servizio.
- NON CERCARE DI APRIRE LO SPORTELLLO se il cestello è in movimento.
- NON montare o immagazzinare l'apparecchio esposto alle intemperie.
- NON cercare di forzare i comandi.
- Devono essere utilizzati solo tubi nuovi forniti insieme all'apparecchio, non riutilizzare tubi vecchi.
- Non riparare o sostituire nessun pezzo dell'apparecchio ed evitare di effettuare qualsiasi operazione di servizio salvo se indicato nel manuale delle istruzioni dell'utente. Nel caso di intervenire, assicurarsi sempre di capire perfettamente le istruzioni e di avere le abilità sufficienti di effettuare le operazioni di riparazione.
- NON eliminare nessun dispositivo di sicurezza o modificare nessun elemento della lavatrice. NON INSTALLARE all'interno della macchina degli elementi ad essa estranei.
- Qualsiasi omissione delle indicazioni descritte nei manuali d'istruzione, può provocare danni personali all'utente. Non si possono prevedere tutte le condizioni e le situazioni possibili con gli avvisi di pericolo e le

avvertenze. Pertanto, il senso comune, la precauzione e l'attenzione sono dei fattori che devono essere apportati dalla/e persona/e che trasporta, installa, usa o possiede la macchina.

- NON usare la macchina se tutti i coperchi e le protezioni non sono stati montati e fissati correttamente
- È OBBLIGATORIO l'addestramento corretto dell'utente da parte del distributore (venditore) durante la messa in funzione.
- Aggiungere alle vaschette corrispondenti le dosi di detergente, ammorbidente e candeggina indicate dal fabbricante. Seguire i consigli di trattamento specifico per ogni tessuto indicati dal fabbricante
- Pulire giornalmente le vaschette per il detersivo e i liquidi. Per la pulizia usare acqua e sapone e non usare mai detersivi abrasivi
- Pulire mensilmente i filtri sulle entrate dell'acqua e i condotti di dosatura esterni.
- Non lavare mai l'esterno direttamente con un getto d'acqua a spruzzo; gli elementi funzionali della macchina possono danneggiarsi.
- Se la lavatrice non si usa per un lungo periodo di tempo, si consiglia di applicare uno strato di vasellina su tutte le superfici di acciaio inossidabile.
- Si raccomanda una revisione generale annuale.

1 USO

1.1 Consigli d'uso

Questa macchina è stata disegnata e concepita per il lavaggio o trattamento dei tessuti in generale. Il suo uso per finalità diverse a quelle indicate, sarà considerato indebito e pericoloso.

Si consiglia di caricare la macchina in base al carico nominale, evitare carichi molto inferiori o superiori.

Non si consiglia di lavare la biancheria inserita all'interno di sacchi, in questo caso, riempire la lavatrice fino a raggiungere il suo carico nominale per evitare possibili squilibri di carico.





Non si consiglia la centrifuga di teli o di capi impermeabili, spazzoloni da pavimento, moquette o tappeti.

Prima di aprire lo sportello, attendere fino a quando il cestello è fermo. Per motivi di sicurezza sportello non si sblocca fino a qualche secondo dopo la conclusione del programma.

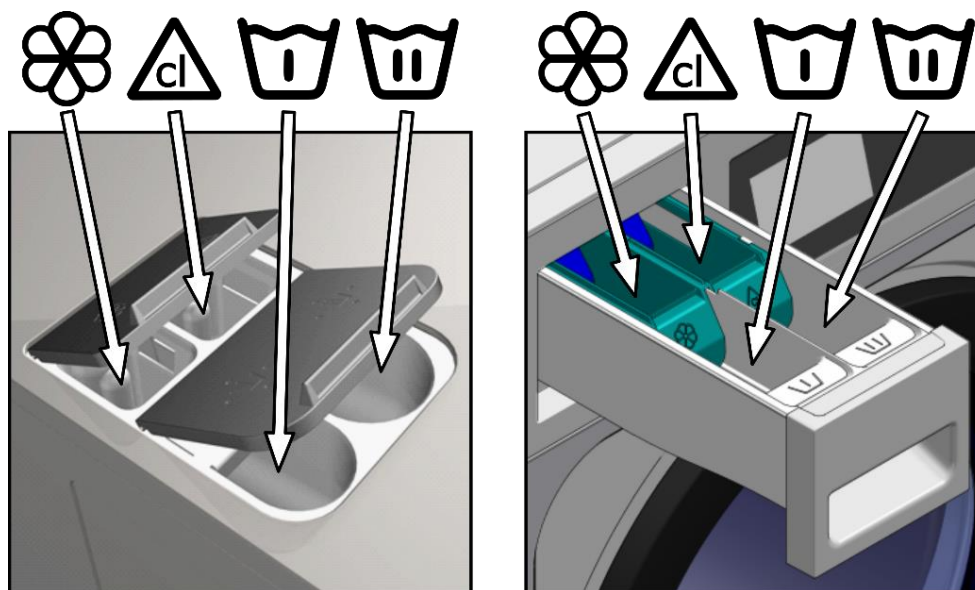
1.2 Uso del dosificador

Aggiungere i prodotti di lavaggio in ogni scomparto e chiudere il coperchio del dosatore.



-  Detersivo in polvere per il prelavaggio
-  Detersivo in polvere per il lavaggio
-  Ammorbidente liquido
-  Sbiancante liquido (candeggina)

1.3 Caratteristiche della macchina

Il comando della macchina, avviene tramite un microprocessore programmabile, in grado di adattarsi alle esigenze di ciascun utente.

È dotata di un comando intelligente per la regolazione della temperatura, se avete a disposizione l'acqua calda, allacciatela. La lavatrice gestirà le diverse entrate dell'acqua per mantenere la temperatura programmata.

È dotata di un comando intelligente per la gestione della centrifuga. La lavatrice controlla lo squilibrio generato dal carico e gestisce la rotazione per garantire una buona centrifuga, senza rumori e allungando la vita utile degli elementi di usura così come un'importante riduzione della fatica nei componenti meccanici.

2 INTERFACCE

Tutte le lavatrici sono dotate di uno schermo a sfioramento dal quale oltre a visualizzare tutte le informazioni consente la selezione di tutti i comandi che compaiono sul display.

Quando la macchina viene alimentata passerà alla *Schermata Off*. Il pulsante ON/OFF conduce alla *Schermata principale*, da questo punto può essere avviato un programma o accedere al menù principale. Pulsando su START si aprirà la *Schermata esecuzione*, che mostrerà sul display tutte le informazioni ad esso relative.

Pulsando su ON/OFF si torna di nuovo alla *Schermata Off* dalla schermata in cui vi trovate.

Le informazioni che compaiono su ciascuna delle schermate possono essere omesse o abilitate dal menù HUD (Consulta la sezione 4.2.1)

2.1 Schermata OFF OPL

Corrisponde alla schermata che appare quando la lavatrice è spenta, mostra i parametri impostati dall'utente.

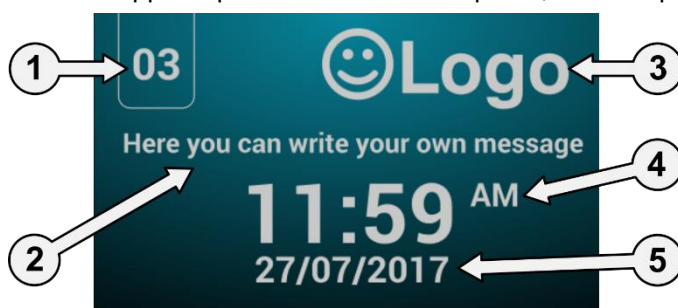

1. **Identificatore della macchina:** Etichetta di identificazione della macchina (se è stato abilitato).
2. **Messaggio lavanderia:** Messaggio impostato dall'utente (se è già stato abilitato).
3. **Logotipo:** Apparirà il logotipo (se è già stato abilitato).
4. **Ora:** Ore e minuti nel formato selezionato.
5. **Data:** La data nel formato selezionato (se è stato abilitato nell'HUD).

Se l'opzione "risparmio energetico" è attiva, trascorsi 10 minuti dallo spegnimento della lavatrice, si spegnerà il backlight [luce di sfondo] del display.

2.2 Schermata principale OPL

La *Schermata principale* della lavatrice è la seguente, in cui vengono definite ciascuna delle opzioni disponibili. Alcune fra le opzioni possono essere omesse dal menù HUD.



1. **Identificatore della macchina:** Etichetta che identifica la macchina
2. **Ora:** Ore e minuti nel formato selezionato.
3. **Peso bucato:** Sul display apparirà il peso del bucato inserito (se il kit di pesatura è attivo) o il carico nominale del modello selezionato (se il kit non è attivo), in cui è possibile modificare il peso del carico inserito. Possibilità di attivare/omettere nell'HUD. Dopo aver selezionato o cancellato il programma, verrà selezionato di nuovo il carico nominale della macchina.
4.  **Menù principale:** Accesso al menù principale della lavatrice, in cui è possibile gestire i diversi parametri della macchina.
5. **Nome del programma:** Nome configurato per il programma selezionato.
6. **Temperatura programma:** Temperatura massima fra le diverse fasi che possiede il programma.
7. **Numero e durata del programma:** Posizione del programma nell'elenco dei programmi (I miei programmi), e la durata, in minuti, stimata per il programma selezionato.
8. **Aumento/diminuzione programma:** Consente di avanzare o retrocedere nell'elenco dei programmi selezionati. Inoltre, con i pulsanti è possibile aumentare/diminuire il programma, premendo direttamente nelle informazioni del programma (quella ubicata sopra il pulsante).
9. **Start:** Pulsante per iniziare l'esecuzione del programma selezionato dalla fase indicata.
10. **Fasi programma:** una volta premuto sull'icona del programma selezionato, appaiono le fasi che formano il programma, e sarà possibile selezionare la fase con la quale si vuole iniziare. Inoltre, vi è anche la possibilità di eseguire una programmazione istantanea, ossia, modificare i parametri che conformano una fase (tempo, temperatura, livello e dosaggio) per l'esecuzione in corso, i valori non verranno più salvati per future esecuzioni.

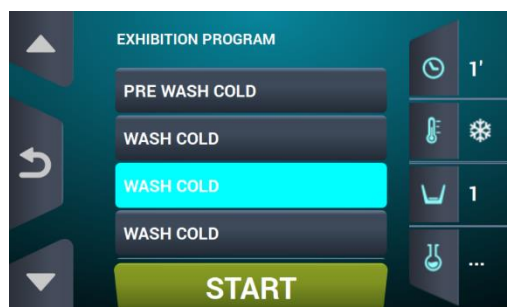

2.3 Schermata di esecuzione OPL

Dopo aver premuto il pulsante START, il programma viene avviato e sul display compaiono tutte le informazioni rilevanti. Alcune fra le opzioni possono essere omesse dal menù HUD.

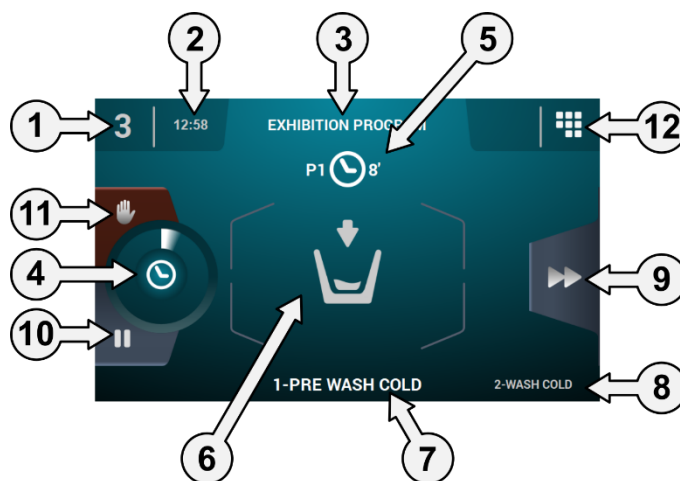



1. **Identificatore della macchina:** etichetta di identificazione della macchina.
2. **Ora:** ore e minuti nel formato selezionato.
3. **Programma in esecuzione:** nome del programma, Numero di programma, Durata programma.
4. **Indicatore di progresso del programma:** stato del progresso del programma, rapporto fra il tempo totale e il tempo residuo del programma.

- Numero e durata del programma:** posizione del programma nell'elenco dei programmi (I miei programmi), e la durata, in minuti, stimata per il programma selezionato.
- Stato (disegno):** disegno animato che mostra cosa sta facendo la lavatrice (riempimento, scarico, lavaggio, risciacquo, centrifuga o anti-infeltrimento).

	Aprendo porta.		Oscillazione frontale.
	Riscaldamento corso		Oscillazione posteriore.
	Antipiega.		Centrifuga in corso.
	Raffreddamento corso.		Terminando.
	Riempimento in corso.		Lavaggio in corso.
	Arresto in corso.		Arresto programmato.
	Estraendo biancheria.		Scarico in corso.

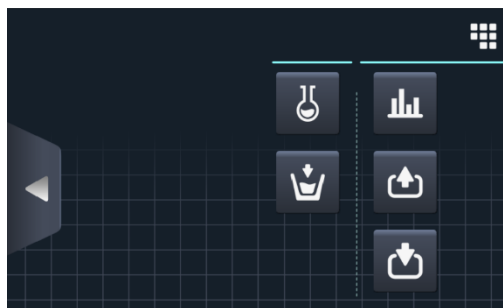
- Fase in esecuzione:** identificatore e nome della fase in esecuzione.
- Fase successiva:** identificatore, nome e disegno della fase successiva (Nel caso in cui si tratti dell'ultima fase non apparirà nulla).
- Fase di avanzamento:** pulsante che consente avanzare alla fase successiva (Nel caso in cui si tratti dell'ultima fase non apparirà nulla). Inoltre, con il pulsante è possibile avanzare di fase, premendo direttamente nelle informazioni della fase successiva (quella ubicata sopra il pulsante).
- Pause:** pulsante che consente eseguire un arresto durante il programma in esecuzione. Nel caso di mettere in pausa il programma, l'icona di pause passerà a quello di play. e sarà possibile ripristinare il programma dal punto in cui è stato interrotto.
- Stop:** pulsante per arrestare il programma. Verrà richiesto il messaggio di conferma.
-  **Menù esecuzione:** accesso ai parametri in corso.



-  **Ingressi:** visualizza lo stato di tutti e ciascuno degli ingressi. Gli ingressi disponibili in TUTTE le macchine, verranno SEMPRE mostrati. Gli ingressi esclusivi di qualche prestazione (ad esempio, Self service, Sanitario, Dosatori extra, Serbatoi (T1, T2, T3), Oscillazione ...) sono disponibili solo se la prestazione è stata attivata.

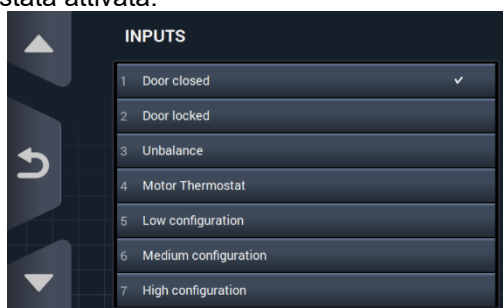

- 
Uscite: visualizza lo stato di ogni uscita. Le uscite disponibili in TUTTE le macchine, verranno SEMPRE mostrate. Le uscite esclusive di qualche prestazione (ad esempio, Self service, Sanitario, Dosatori extra, Serbatoi (T1, T2, T3), Oscillazione ...) sono disponibili solo se la prestazione è stata attivata.

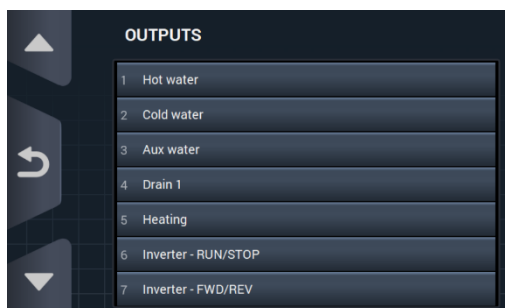

- 
Valori prefissati/valori: visualizzazione dei valori prefissati e dei valori reali della fase in esecuzione (Temperatura, Livello, Tempo residuo). Premere i pulsanti sulla colonna destra, i valori di riferimento possono essere modificati, producendo effetti solo per l'esecuzione in corso.

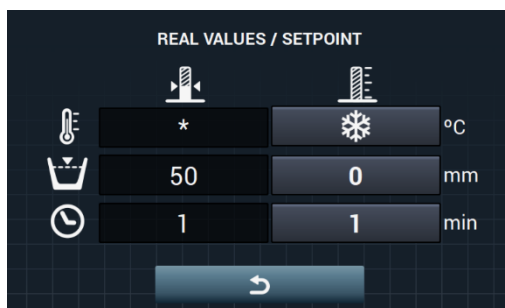

- 
Dosaggio manuale: è consentito accedere a questa sezione, verrà visualizzato lo stato di ogni dosatore (ON/OFF) ed è possibile attivare/disattivare il dosaggio preferito. Le opzioni disponibili dipendono dalla configurazione dei kit presenti. Una volta usciti dalla schermata di dosaggio, verranno disattivati tutti i dosatori.

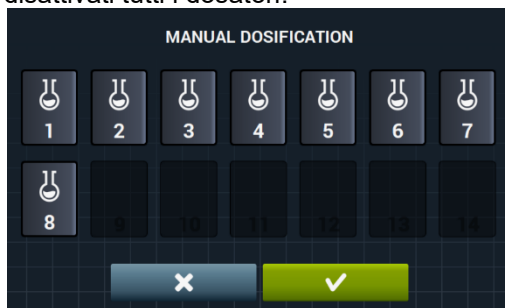

- 
Entrata di acqua manuale: è consentito accedere a questa sezione, verrà visualizzato lo stato di ogni entrata di acqua (ON/OFF) ed è possibile attivare quella preferita. L'entrata di acqua attivata dall'algoritmo di riempimento, non potrà essere disattivata. Mentre si esce dalla schermata dell'entrata di acqua, verranno disattivate tutte le entrate di acqua attivate manualmente.

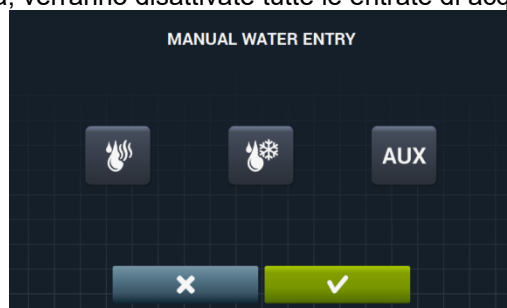

3 PROGRAMMI

È presente una biblioteca di programmi composta da tutti i programmi che possiede per difetto, così come i programmi creati dall'utente stesso.





Prima di illustrare la gestione dei programmi (consultare la sezione 4.1), , verrà spiegato quali sono i parametri e quali sono i programmi standard che possiede la biblioteca.





3.1 Parametri di fase

Ogni programma è formato da una serie di fasi, le quali sono composte da un insieme di parametri configurabili, in base al tipo di fase in oggetto.

3.1.1 Parametri per fasi di ammollo, prelavaggio, lavaggio o risciacquo:



- Nome fase:** nome che identifica la fase. Non corrisponderà al testo che appare sulla *Schermata di esecuzione*, bensì quello che identifica una fase creata.
- 
Tempo: valore, in minuti, della durata della fase. Range configurabile da 1 a 99..
- 
Temperatura: temperatura, °C ó °F, di esecuzione della fase.
- Range configurabile da 20°C (68°F) a 90°C (194°F).
- 
Livello: livello di acqua alla quale configurare la fase. Intervalli configurabili (vedi sezione 4.2)). Sono presenti 5 tipi di livelli: Minimo (1), Basso (2), Medio (3), Alto (4), Massimo (5).
- 
Velocità: velocità di esecuzione della fase. Intervalli configurabili (vedi sezione 4.2). Sono presenti 4 tipi di velocità diverse da scegliere: Minima (1), Bassa (2), Media (3), Alta (4).
- 
Ritmo di lavaggio: sequenza di movimento che deve seguire la lavatrice (tempo di avvio (sec.) / tempo di arresto (sec.)). Range configurabile da 1 a 99. Il cestello girerà alterando a sinistra e a destra.

- 
Ingresso acqua: indica la selezione dell'ingresso di acqua preferita.
 - Acqua calda: Carica acqua dalla rete idrica calda (Si/No)
 - Acqua fredda: Carica acqua dalla rete idrica fredda (Si/No)
 - Ausiliare: Carica acqua dalla rete idrica ausiliaria (Si/No)
 - Regolazione dell'acqua: Carica acqua da uno degli ingressi a seconda della temperatura (Si/No).
 - T1, T2, T3: Carica acqua da uno dei serbatoi in caso di avere il KIT di recupero.
- 
Scarico: mostra se deve essere scaricata l'acqua una volta terminata la fase, indicando quale uscita utilizzare per lo scarico nel caso di avere il kit di recupero acqua attivo.
- 
Raffreddamento: opzione che consente raffreddare la temperatura in una fase prima di scaricare o passare alla fase successiva. Parametro configurabile solo se la temperatura della fase è uguale o superiore a 40°C (104°F). Range configurabile di 30°C (86°F) al valore prefissato della fase.
 Oltre a consentire la selezione del valore di raffreddamento, è stato impostato un pulsante per attivare o disattivare tale opzione.
- 
Dosaggio 1..8: Ogni dosaggio può essere attivato indipendentemente, a condizione di configurare i seguenti parametri nel caso in cui viene attivato:
 - Inizio: Se il dosaggio X è attivo, deve essere indicato quando cominciare tale dosaggio



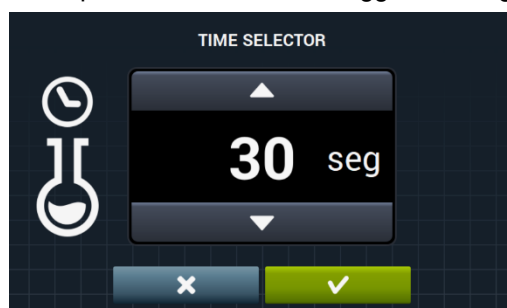

- Livello di sicurezza (ML): Inizia a dosare quando si raggiunge il livello di sicurezza.
 - Livello (L): Inizia a dosare quando si raggiunge il livello impostato.
 - Temperatura (T): Inizia a dosare quando si raggiunge la temperatura impostata.
- Tempo: Tempo, in secondi, del dosaggio X. Range configurabile da 0 a 99.



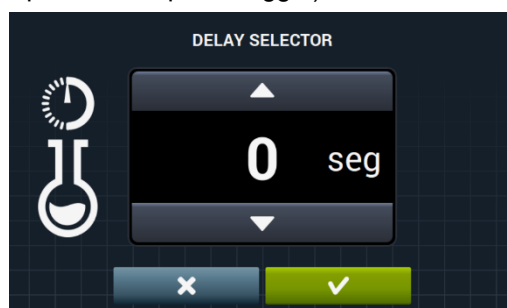

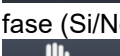

- Ritardo: Ritardo, in secondi, del dosaggio X. Da momento in cui raggiunge il punto di inizio indicato, il dosaggio ritarda in base al tempo impostato. Range configurabile da 0 a (tempo fase-tempo dosaggio).

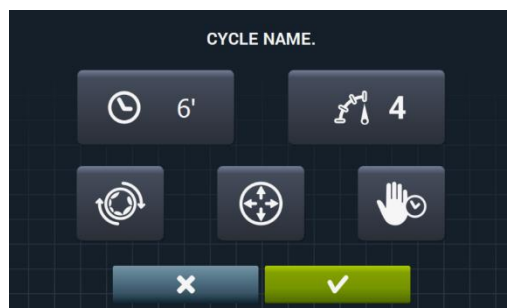

-  **Muovere riempiendo:** rotazione del cestello mentre si riempie (Si/No).
-  **Movimento durante lo scarico:** rotazione del cestello mentre si scarica (Si/No).
-  **Arresto termico:** indica il momento dal quale inizia a decorrere il tempo prefissato per la fase (Si/No).
-  **Arresto programma:** consente di realizzare un arresto nel programma prima che inizi l'esecuzione della fase in oggetto. L'arresto verrà indicato sul display e avvisato tramite segnale acustico. (Si/No)
Se questo parametro è attivo, prima di iniziare la fase, la lavatrice passerà allo stato di pause, e sul display comparirà il messaggio "Pausa programmata". Per continuare con l'esecuzione del programma, premere il pulsante PLAY.

3.1.2 Parametri per le fasi della centrifuga:

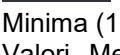
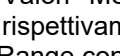









-  **Tempo:** valore, in minuti, della durata della centrifuga. Range configurabile da 1 a 99.
-  **Velocità:** velocità di centrifuga. Sono presenti 4 tipi di velocità diverse da scegliere: Minima (1), Normale (2), Media (3), Massima (4). Valori Medio (3) e Massimo (4) disponibili solo nel caso di lavatrici dai giri alti e medi rispettivamente. Range configurabile.
-  **Antipiega:** esegue l'antipiega alla fine della fase di centrifuga (Si/No).
-  **Distribuzione ottima:** nel caso in cui quest'opzione è attiva, lo scarico non verrà eseguito nella fase anteriore.
-  **Arresto programma:** consente di realizzare un arresto nel programma prima che inizi l'esecuzione della fase in oggetto. L'arresto verrà indicato sul display e avvisato tramite segnale acustico. (Si/No).

3.2 Biblioteca delle fasi

Queste sono le fasi che verranno inserite nella biblioteca delle fasi per difetto, si tratta di fasi che verranno utilizzate per creare nuovi programmi.

- Ammollo
 - **F1:** Ammollo
- Prelavaggi
 - **F2:** Prelavaggio normale freddo
 - **F3:** Prelavaggio normale 40°C (104°F)
 - **F4:** Prelavaggio delicato freddo
 - **F5:** Prelavaggio delicato 40°C (104°F)
 - Prelavaggio molto delicato freddo
 - **F7:** Prelavaggio molto delicato 40°C (104°F)
 - **F8:** Prelavaggio wet
- Lavaggi
 - **F9:** Lavaggio normale freddo
 - **F10:** Lavaggio normale 60°C (140°F)
 - **F11:** Lavaggio normale 90°C (194°F)
 - **F12:** Lavaggio delicato Freddo
 - **F13:** Lavaggio delicato 40°C (104°F)
 - **F14:** Lavaggio molto delicato freddo
 - **F15:** Lavaggio molto delicato 40°C (104°F)
 - **F16:** Lavaggio wet Freddo
 - **F17:** Lavaggio wet 40°C (104°F)
- Risciacqui
 - **F18:** Risciacquo normale
 - **F19:** Risciacquo normale finale
 - **F20:** Risciacquo delicato
 - **F21:** Risciacquo delicato finale
 - **F22:** Risciacquo molto delicato
 - **F23:** Risciacquo molto delicato finale
 - **F24:** Risciacquo wet
 - **F25:** Risciacquo wet finale
- Centrifughe
 - **F26:** Centrifuga lunga
 - **F27:** Centrifuga breve

Simboli delle fasi:

	Ammolli	
	Prelavaggi	 : Prelavaggio freddo,  40: Prelavaggio 40°C (104°F),
	Lavaggi	...
	Risciacqui	 : Risciacquo,  : Risciacquo finale con ammorbidente
	Centrifughe	

Simboli e valori dei parametri:

















































	Tempo	Valori in minuti
	Temperatura	Valori in °C (°F)
	Livello	1:Minimo,2:Basso, 3: Medio, 4:Alto, 5:Massimo
	Velocità di lavaggio	1:Minimo,2:Basso, 3:Normale, 4:Alto,
	Velocità di centrifuga	2:Normale, 3: Medio 4:Massimo
	Ingresso acqua	0:Fredda, 1:Fredda/Calda secondo regolazione
	Ritmo di lavaggio	Tempo di avvio (sec.) ; Tempo di arresto (sec.)
	Muovere riempiendo:	✓ : Si
	Arresto termico	✓ : Si
	Movimento durante lo scarico	✓ : Si
	Scarico	✓ : Si
	Raffreddamento	✓ : Si
	Distribuzione ottima	✓ : Si
	Fermata programma:	✓ : Si
	Antipiega	✓ : Si
D	Dosaggio	Ingresso dalla zona di dosaggio (D1: Dosaggio 1, ...) con il suo INIZIO/TEMPO/RITARDO configurato a ML/0/30

Tabelle delle fasi con i loro parametri:

	F1		F2		F3		F4		F5		F6		F7		F8
															
	3		5	5	6	6	6	6	6	6	6	6	6	5	
	3			40		40			40			40			
	3		1	1	3	3	3	3	3	3	3	3	3	3	
	0		3	3	2	2	2	2	2	2	2	2	2	1	
	15;05		0	1	0	1	0	1	0	1	0	1	0	0	
	✓		15;05	15;05	10;08	08;06				5;15		5;15		02;02	
	✓		✓	✓										✓	
	✓			✓		✓			✓			✓			
			✓	✓										✓	
			✓	✓	✓	✓	✓	✓	✓	✓	✓	✓	✓	✓	✓
D		D	D1	D1	D1	D1	D1	D1	D1	D1	D1	D1	D1	D1	D1

	F9	F10	F11	F12	F13	F14	F15	F16	F17
	10	10	10	12	12	12	12	10	10
		60	90		40		40		40
	1	1	1	1	1	1	1	2	2
	3	3	3	2	2	2	2	1	1
	0	1	1	0	1	0	1	0	1
	15;05	15;05	15;05	10;08	10;08	05;15	05;15	02;02	02;02
	✓	✓	✓					✓	✓
		✓	✓		✓		✓		✓
	✓	✓	✓					✓	✓
	✓	✓	✓	✓	✓	✓	✓	✓	✓
D	D2, D3	D2, D3	D2, D3	D2	D2	D2	D2	D2	D2

	F18	F19	F20	F21	F22	F23	F24	F25
	2	2	3	3	3	3	2	2
	4	4	4	4	4	4	4	4
	3	3	2	2	2	2	1	1
	15;05	15;05	10;08	10;08	05;15	05;15	02;02	02;02
	✓	✓					✓	✓
	✓	✓					✓	✓
	✓	✓	✓	✓	✓	✓	✓	✓
D		D4		D4		D4		D4

	F26	F27
	2	6
	2	4
	✓	✓
	✓	✓

3.3 Biblioteca dei programmi

Questi sono i programmi che verranno inseriti nella biblioteca dei programmi per difetto:

P1: Energetico 90°C (194°F)	P10: Extra delicato freddo
P2: Energetico 60°C (140°F)	P11: Economico 90°C (194°F)
P3: Energetico 30°C (86°F)	P12: Economico 60°C (140°F)
P4: Energetico freddo	P13: Economico 30°C (86°F)
P5: Normale I 60°C (140°F)	P14: Economico freddo
P6: Normale I 30°C (86°F)	P15: Sluice
P7: Normale freddo	P16: Centrifuga lunga
P8: Delicato 40°C (104°F)	P17: Centrifuga corta
P9: Delicato freddo	



La tabella di tutti i programmi con il suoi programmi è disponibile all'ultima pagina del manuale.

4 CONFIGURAZIONE

Di seguito viene mostrato il menù principale di configurazione della lavatrice, dal quale si possono configurare diversi parametri della lavatrice, così come visualizzare o scaricare i dati memorizzati.

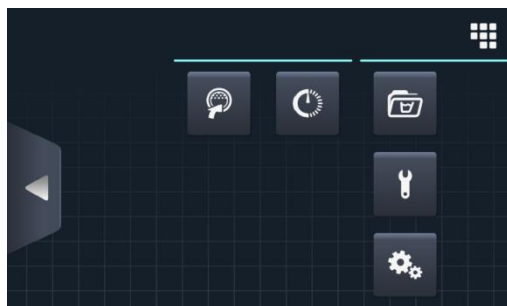
Questo menù è accessibile dall'icona  della **Schermata principale** (consultare la sezione 2.2)





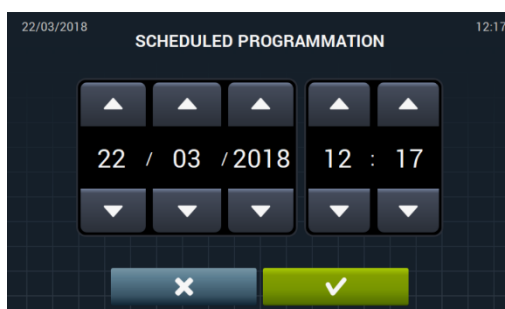

-  **Easy load:** opzione che consente di caricare il bucato.
-  **Programmazione ritardata:** consente di ritardare un lavaggio per realizzarlo nella data/ora preferita. Dopo aver premuto il pulsante di "programmazione ritardata", viene richiesto l'inserimento di data/ora prescelta.

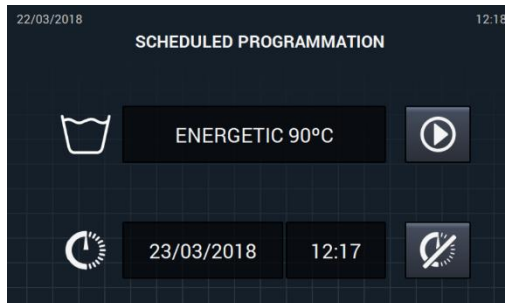

Si passerà a una schermata in cui viene indicata la data/ora programmata, insieme al numero e nome del programma.



-  Esecuzione del programma prima dell'ora prevista.
-  Cancellare la programmazione effettuata.
-  **Gestione dei programmi:** gestione di tutti i programma memorizzati, così come dei programmi attivi in quel momento. (consultare la sezione 4.1)
-  **Configurazione del sistema:** configurazione delle diverse sezioni della lavatrice. (consultare la sezione 4.2)
-  **Manutenzione:** diverse opzioni per il tecnico protette da password.



4.1 Gestione dei programmi

Da questo sottomenù è possibile gestire tutti i programmi, sia quelli selezionati dall'utente come quelli che si trovano nella biblioteca. A questo proposito, selezionare fra "Biblioteca delle fasi", "I miei programmi", e "Biblioteca dei programmi".

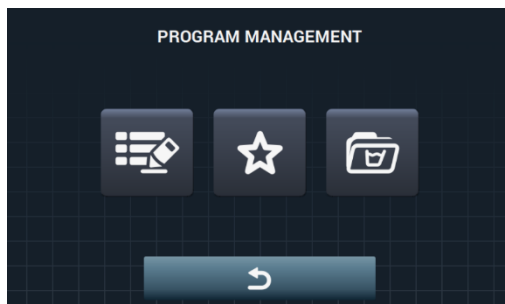
Accesso: [Schermata principale]  → [Menù Principale] 





Vi sarà una biblioteca in cui verranno registrati tutti i programmi e le fasi, i programmi inclusi per difetto e i programmi creati/importati dall'utente.

-  **I miei programmi:** disponibili sulla Schermata principale OPL. (Vedi sezione 4.1.1)
-  **Biblioteca dei programmi:** (Vedi sezione 4.1.2)
-  **Archivio delle fasi:** (Vedi sezione 4.1.3)

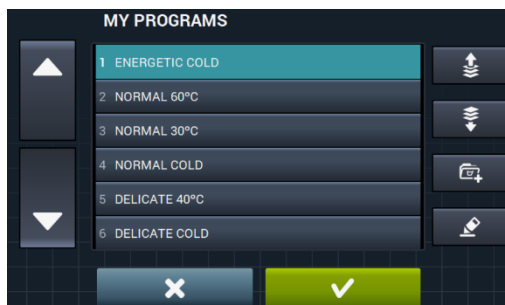

4.1.1 I miei programmi (preferiti).

I programmi nel file "I miei programmi" sono quelli che saranno disponibili nella Schermata principale OPL.

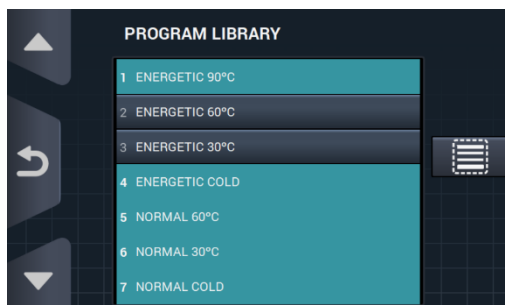

-  **Aggiungere/eliminare programmi:** premendo il pulsante si accede all'archivio dei programmi. All'interno dell'archivio, i programma inclusi attualmente come "I miei programmi" sono evidenziati, e potranno essere selezionati/deselezionati uno per volta tutti quei programmi che vogliamo aggiungere/eliminare dai preferiti.
 -  **Selezionare/deselezionare tutto:** seleziona o deseleziona tutto l'elenco dell'archivio dei programmi.



-  **“freccia su”** e  **“freccia giù”**: possiamo cambiare la posizione di qualsiasi programma fra i favoriti, e posizionare i programmi dei favoriti nell'ordine preferito.
-  **Pulsante modifica**: la selezione di questo pulsante, ci consentirà di entrare e modificare il programma selezionato come se si trattasse di una modifica dalla biblioteca dei programmi.



Premendo OK o Cancel torniamo a I miei programmi.

4.1.2 Biblioteca dei programmi

È possibile aggiungere, copiare, modificare o cancellare programmi, oltre a importare nuovi programmi o esportarli verso una memoria USB esterna.



-  **Crea programma**: Creazione di nuovi programmi di lavaggio, cominciando dalle fasi esistenti nella biblioteca. Se premiamo questo pulsante, innanzitutto ci richiederà di inserire il nome del nuovo programma.

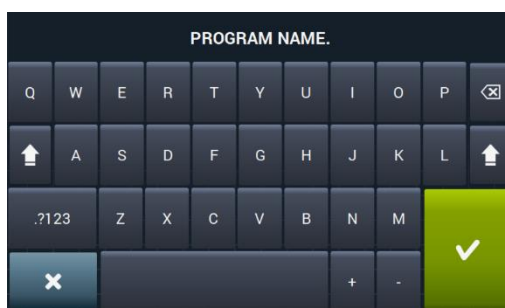

Successivamente ci mostrerà la schermata successiva (senza nessuna fase) per poter aggiungere fasi dalla biblioteca delle fasi.

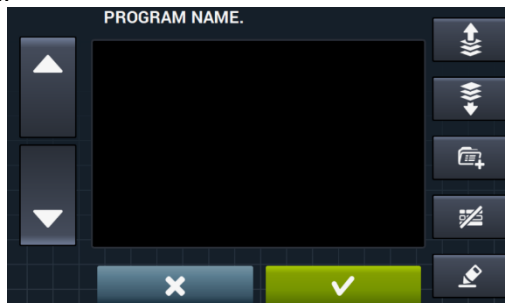







È possibile aggiungere fasi dalla biblioteca delle fasi, in cui è consentito filtrare le fasi che vogliamo visualizzare in base al tipo di fase.





Dopo aver selezionato la fase, è possibile consultare i parametri delle fasi della biblioteca prima di aggiungerle al programma in fase di creazione.





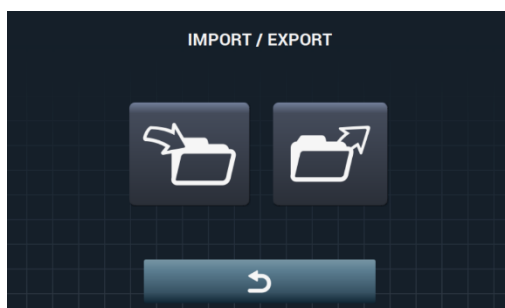

Ogni programma sarà l'insieme di parametri raggruppati per fasi che non hanno nessun rapporto con le fasi presenti nella biblioteca.

- 
Copia programma: Copia di un programma già presente nella biblioteca, al quale viene assegnato un nuovo nome.
- 
Modifica programma: Modifica sia del nome del programma sia delle fasi che lo formano, in cui è possibile aggiungere, modificare, cancellare o cambiare l'ordine delle fasi già esistenti. Così come per la creazione di un nuovo programma, per modificarlo sarà possibile aggiungere/cancellare le fasi dalla biblioteca delle fasi. Per la creazione di programmi è consentito consultare solo i parametri delle fasi mentre per modificarli si permette di modificare le fasi già esistenti nel programma.
- 
Cancella programma: Cancellazione dei programmi memorizzati nella biblioteca.
- 
Importa/Esporta configurazione: consente l'importazione/esportazione di programmi da una memoria USB esterna.



- 
Importa programma: Consente l'importazione di programmi da una memoria USB esterna. L'accesso all'USB, verrà mostrato solo nei file con estensione ".prg" oltre cartella.

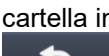

-  **Marcatore:** Indica il numero dei programmi selezionati.
-  **Selezionare/deselezionare tutto:** seleziona o deseleziona tutti i programmi della cartella in cui si trovano.
-  **Indietro:** Consente di uscire dalla cartella in cui si trova.
Nel caso di importare un programma con lo stesso nome di uno già esistente, vi verrà richiesto se si vuole sostituire il programma in oggetto o cancellare l'operazione. Poiché potrebbero essere molti i programmi che si trovano nella stessa situazione, vi è una casella per "fare lo stesso in tutti i casi".
-  **Esporta programma:** Esportazione di programmi esistenti nella biblioteca verso una memoria USB esterna.



Sarà possibile selezionare i programmi che si vogliono essere esportati.

-  **Selezionare/deselezionare favoriti:** consente la selezione di tutti i programmi o i programmi che si trovano all'interno di favoriti, indicando in ogni momento il numero di programmi selezionati.

Tutti i programmi selezionati verranno salvati in un file dal nome "PROGRAMS" nella directory radice dell'unità flash USB e ogni programma corrisponderà a un file.

4.1.3 Biblioteca delle fasi

Dalla biblioteca delle fasi è possibile modificare il nome di ogni fase. Una volta incluso in un programma, quando verranno visualizzate le informazioni delle fasi, il nome che verrà mostrato per la fase sarà uno diverso. Si tratterà di un nome dinamico formato dal tipo di fase e un parametro T°, giri/min).

La libreria delle fasi è modificabile, poiché consente di creare, modificare, copiare o cancellare le fasi esistenti (Vedi la sezione 3.1.).





-  **Crea fase:** creazione di nuove fasi di lavaggio. Se premiamo questo pulsante, innanzitutto ci richiederà di inserire il nome del nuovo programma.

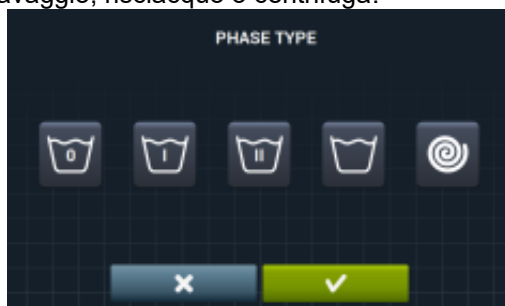

Di seguito apparirà la seguente schermata per poter selezionare il tipo di fase che si vuole creare, ammollo, prelavaggio, lavaggio, risciacquo o centrifuga.







-  **Copia fase:** copia di una fase già presente nella biblioteca, al quale viene assegnato un nuovo nome.
-  **Cancella fase:** cancellazione delle fasi memorizzate nell'archivio.
-  **Modifica fase:** modifica dei parametri della fase selezionata.

4.2 Configurare Sistema

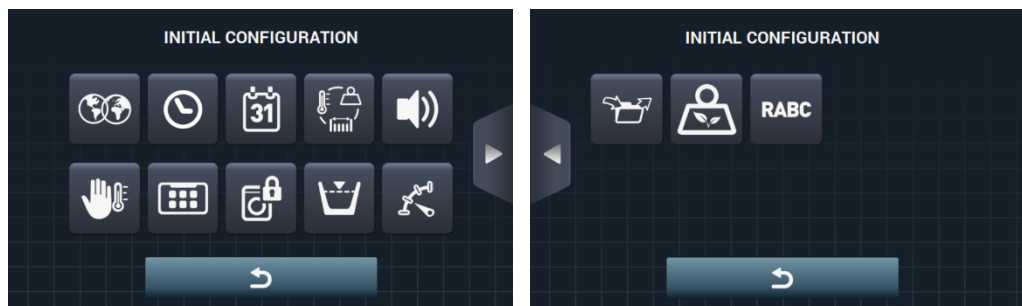
Accesso: [Schermata principale]  ⇒ [Menù Principale] 

Nella configurazione del sistema è consentito configurare le seguenti sezioni:



-  **Schermata successiva.**
-  **Schermata precedente.**
-  **Lingua:** i testi della lavatrice possono essere visualizzati in 34 lingue diverse, anche se la modifica dei testi può essere realizzata utilizzando solo caratteri occidentali.

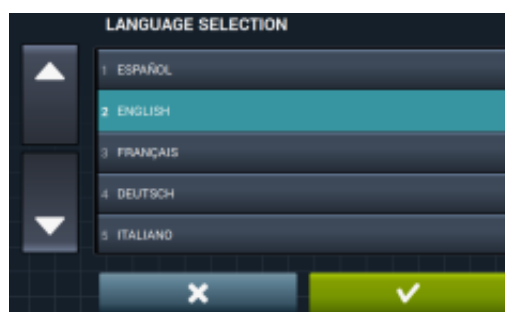

-  **Ora:** configurazione dell'ora attuale. È consentito selezionare il formato di visualizzazione 812 ore / 24 ore (per difetto).

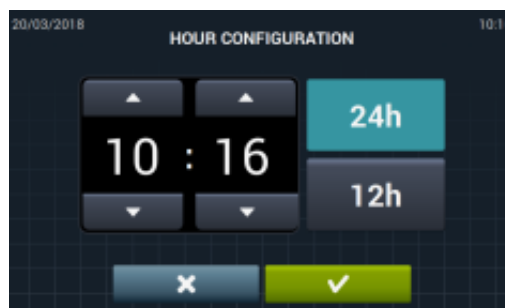

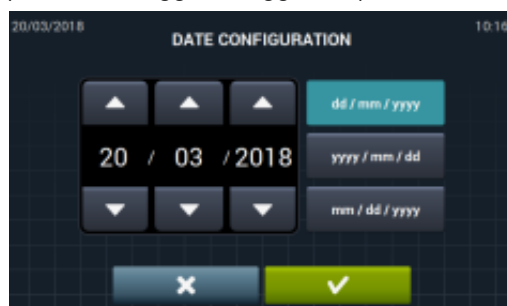

- 
Data: configurazione della data attuale. È consentito selezionare il formato di visualizzazione (gg/mm/aaaa (per difetto) / aaaa/mm/gg / mm/gg/aaaa).







- 
Unità di misura: consente la selezione dell'unità di misura con la quale si preferisce visualizzare la temperatura (°C (per difetto) o °F), il peso (Kg (per difetto) o Lb) e la dimensione (mm (per difetto) o in).







- 
Arresto termico: configurazione generale dell'arresto termico. Quando è abilitato, non si verificherà alcun arresto termico anche quando nella fase in esecuzione tale parametro è attivo. Invece, se è stato attivato, verrà rispettata la configurazione di ogni fase e si agirà di conseguenza. Per difetto, attivo. Nelle macchine prive di riscaldamento (HW) è sempre disattivato.
- 
Risparmio idrico nel pesato: È consentito configurare il risparmio idrico preferito per il peso, scegliendo fra 3 opzioni diverse di peso e 3 livelli di risparmio. Secondo il carico, la riduzione dell'acqua e il dosaggio del detersivo variano.

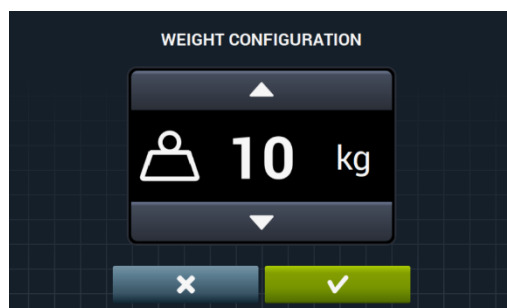

- 
 Opzione di peso disattivato.
- 
 Opzione di pesatura automatica, sarà disponibile in base alla configurazione dei kit esistenti.
- 
 Opzione di pesatura manuale, verrà inserito il peso della biancheria in modo manuale, facendo clic sull'icona del peso sulla schermata principale (Vedi sezione 2.2, punto 3).
- 
 Opzione di pesatura intelligente, quest'opzione consente una stima di carico all'inizio di qualsiasi programma. Il messaggio "LOAD DETECTION" apparirà durante l'esecuzione. Quest'opzione può tardare diversi minuti. Il tempo impiegato non è previsto nella durata del programma..



-  Opzione di risparmio disattivato.
-  Opzione di risparmio basso.
-  Opzione di risparmio medio.
-  Opzione di risparmio alto.
-  **Livelli:** consente la configurazione in mm dei 5 livelli configurabili. Ogni tipo di livello avrà un valore per difetto e un range di configurazione, valori che dipendono dal modello selezionato. (Consulta la tabella dei livelli per modello).



-  **Velocità:** consente la configurazione in GIRI dei diversi tipi di velocità presenti, sia nel lavaggio che nella centrifuga. Ogni tipo di velocità avrà un valore di configurazione minimo e massimo. (Consulta la tabella delle equivalenze GIRI/V per modello).

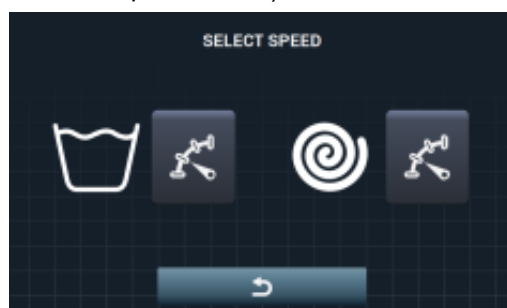

- 
Importa/Esporta configurazione: consente di importare dalla memoria USB una configurazione della macchina o esportare a una memoria USB la configurazione attuale della macchina. Quando si preme questo pulsante, apparirà una schermata intermedia per selezionare l'importazione o l'esportazione (come nei programmi).

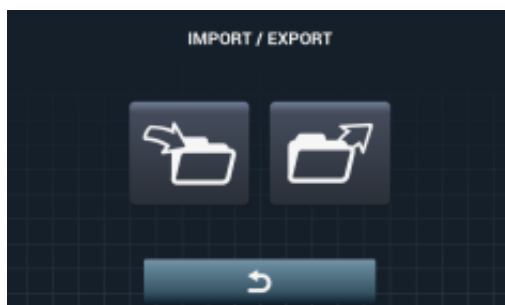

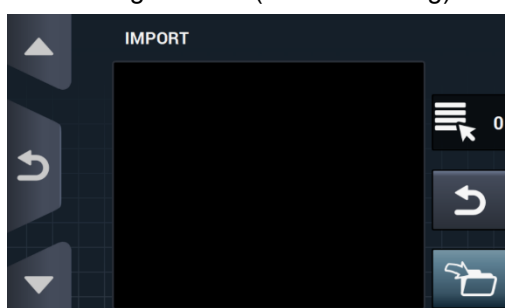

Se viene selezionato IMPORTA, apparirà la schermata per navigare nell'USB, anche se potranno essere selezionati solo i file di configurazione (estensione .cfg).



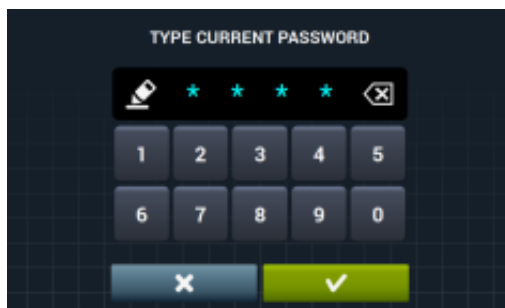

Se selezioniamo ESPORTA, la configurazione attuale della macchina verrà salvata nella directory radice del file "CONFIG". Ogni file di configurazione verrà denominato nel seguente modo: CONFIG_Modello_Data_ora.cfg.

- 
Accesso limitato: consente di limitare la configurazione della lavatrice, impostando una password per entrare nel menù principale. Per difetto, disattivato. È possibile configurare la password preferita (1234 per difetto) per entrare nel menù principale.



- 
HUD: la configurazione HUD attiva/disattiva la visualizzazione dei parametri nelle diverse schermate (vedi sezione 4.2.1).



-  **Beep:** opzione che consente disattivare il cicalino. Per difetto, attivato.
-  **RABC/Tracciabilità:** le informazioni di ogni lavaggio verranno memorizzate e salverà le seguenti informazioni:
 All'inizio di ogni ciclo: Programma, ora d'inizio, peso (se presente)
 Durante l'esecuzione, ogni 15 secondi: Livello, temperatura ed errore (se presente)
 Per scaricare i dati sarà necessario selezionare il periodo prescelto (per difetto, la data d'inizio e la data di fine, il giorno attuale).
 I dati verranno salvati almeno per 15 giorni.
 Ogni volta che si verifica un download, verrà creato un "RABC" nella directory radice dell'unità flash USB.
 Ogni file in rabc verrà denominato nel seguente modo: RABC_Modello_Data_ora.rabc.

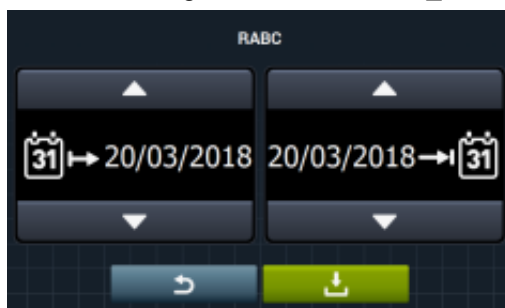

4.2.1 Configurazione HUD

Configurazione dei parametri che vogliamo visualizzare sulla schermata OFF, *schermata principale* e *schermata di esecuzione*, oltre alla configurazione dello spegnimento automatico e del risparmio energetico.

Accesso: [Schermata principale]  ⇒ [Menù Principale]  ⇒ [Configura sistema] 



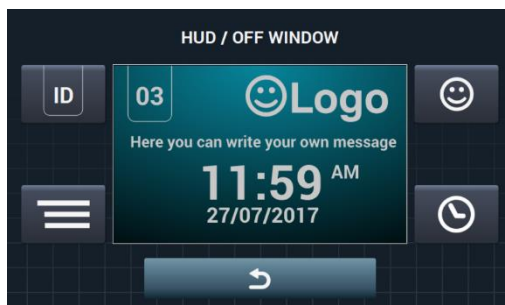

-  **Schermata OFF:** Questi sono i parametri che possono essere configurati:



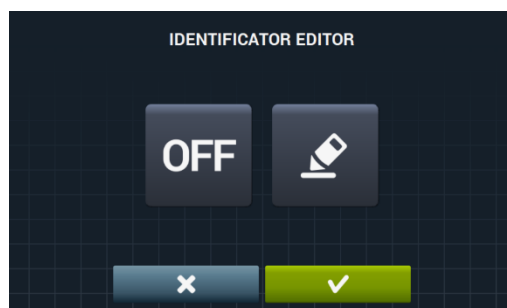

-  **Identificatore della macchina:** È consentito attivare/disattivare l'identificazione della macchina, oltre a modificare il numero che gli vogliamo assegnare (Fra 1 e 99). Per difetto, disattivato. Quest'identificatore è obbligatorio nel caso di utilizzare una comunicazione a distanza.



L'identificatore della macchina può essere attivato premendo il pulsante "OFF"  e poi il pulsante di modifica .



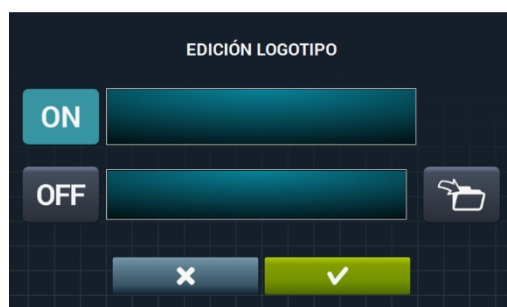

-  **Data:** Opzione che può essere attivata/disattivata. Per difetto, attivato.
-  **Logotipo:** Consente di selezionare la visualizzazione del logotipo. Per difetto, attivato.

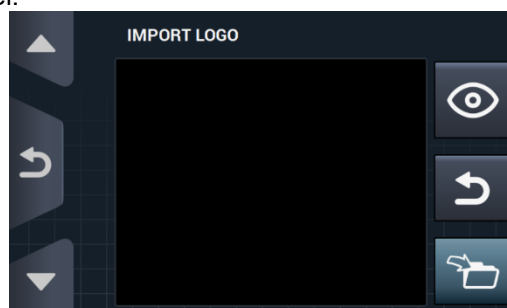

Facendo clic sul pulsante di importa , è possibile importare un logotipo della macchina da una memoria USB esterna, il file del logotipo deve avere un formato .png e con una risoluzione di 290 x 80 pixel.





Il pulsante di pre-visualizzazione , ci consente di verificare che il logotipo appare correttamente.

-  **Messaggio lavanderia:** Messaggio d'inizio che può essere modificato dall'utente (Max. 40 caratteri). Per difetto, disattivato.



- **Schermata principale:** di seguito verranno mostrati i parametri configurabili:









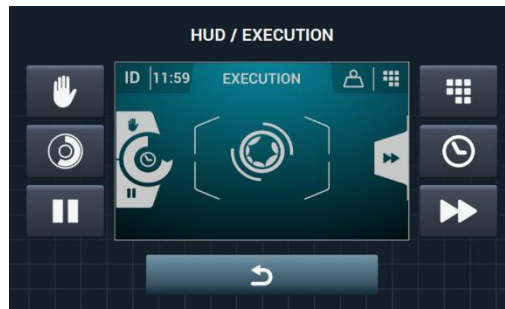

-  **Ora:** opzione che consente di mostrare/nascondere l'ora. Per difetto, attivato.
-  **Peso bucato:** In caso di disattivare quest'opzione, non apparirà l'icona del peso. Per difetto, disattivato.
-  **Programmazione istantanea:** Se la programmazione istantanea è stata disattivata, ciò consentirà di visualizzare i parametri di ogni fase ma non potranno essere modificati. Per difetto, attivato.





- **Schermata di esecuzione:** queste sono le opzioni consentite dalla schermata di esecuzione:



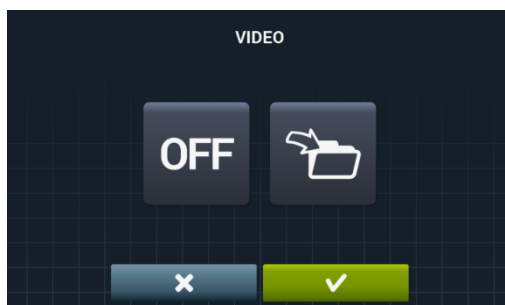

-  **Ora:** opzione che consente di mostrare/nascondere l'ora. Per difetto, attivato.
-  **Tempo restante:** opzione per mostrare/nascondere il tempo residuo totale e l'indicatore di progresso del programma dalla schermata di esecuzione. Per difetto, attivato.
-  **Pulsante di arresto, STOP:** consente di nascondere il pulsante di arresto. Per difetto, attivato.
-  **Pulsante di PAUSE:** consente di nascondere il pulsante di pause. Per difetto, attivato.
-  **Pulsante di menù:** opzione che consente di mostrare/nascondere l'icona del menù di esecuzione. Per difetto attivato.
-  **Pulsante di avanzamento:** consente di nascondere il pulsante di avanzamento e le informazioni relative alla fase successiva. Per difetto, attivato.
-  **Spegnimento automatico:** nel caso in cui quest'opzione è attiva e si trova nella schermata principale, si passerà alla *Schermata Off* una volta trascorsi 30 minuti senza nessuna attività. Per difetto, attivato.
-  **Risparmio energetico:** opzione che consente di risparmiare energia spegnendo il backlight del display trascorsi 10 minuti dallo spegnimento della lavatrice. Se si tocca qualsiasi zona del display il backlight [luce di sfondo] si accenderà di nuovo e si tornerà alla schermata d'inizio. Per difetto, attivato.

-  **Importa video:** può riprodurre un video sulla schermata della macchina dopo 10 minuti di inattività. Se si attiva il "Risparmio energetico" automaticamente, verrà disattivata la riproduzione del video.

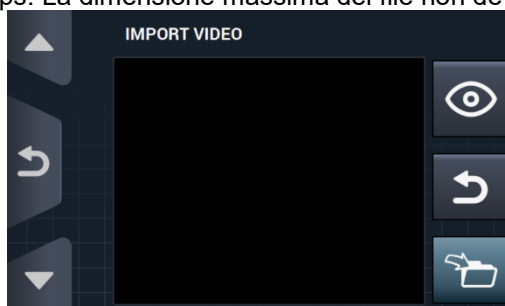

Facendo clic sul pulsante di importazione , può essere importato un video alla macchina da una memoria USB esterna, possono essere importati solo file di video (avi, mov,...), e sarà possibile conservare un file del video installato nella macchina. La risoluzione dei video sarà, per le macchine con uno schermo di 4,3" di 480x272 pixel, e per le macchine con uno schermo di 7" di 800x480 pixel. Non si consiglia che superi 16 Fps. La dimensione massima del file non deve superare i 25Mb.



Il pulsante di pre-visualizzazione , ci consente di verificare la corretta riproduzione del file di video.

5 MANUTENZIONE

5.1 Anomalie elettriche e meccaniche

Prima di rivolgersi al Servizio di Assistenza Tecnica, controlla:

- Che ci sia corrente alla macchina.
- Lo stato dei fusibili.
- Che la tensione coincide con quella della macchina.

Se la lavatrice non raggiunge il livello dell'acqua, controlla:

- Che il rubinetto di arresto dell'acqua è aperto.
- Che il filtro per l'entrata dell'acqua non è ostruito.
- Che la pressione dell'acqua della rete di fornitura è compreso tra 2/4 Kg/cm² (28/56 psi).

Se la lavatrice vibra eccessivamente verificare che le viti dei pannelli non sono allentati.

In caso di un'interruzione della tensione elettrica: La vasca si svuota e lo sportello resta bloccato. Se si vuole togliere il bucato dalla lavatrice, si può aprire lo sportello spingendo verso il basso l'anello sul dorso del pannello anteriore.

5.2 Avvisi

Tutti gli avvisi ed errori verranno visualizzati sul display accompagnati da un avviso acustico. In caso di errore, verranno conservate tutte le informazioni di fase e stato per sapere esattamente dove si è verificato l'errore.

Questi sono gli avvisi che possono verificarsi in una lavatrice:

DESCRIZIONE	CAUSA E AZIONE
SPORTELLO APERTO	Se all'inizio di un programma lo sportello è aperto, sullo schermo comparirà il messaggio "SPORTELLO APERTO" e suonerà per 30 secondi per non suonare più successivamente. Offrirà solo l'opzione di "OK"- Il programma non comincerà e l'utilizzatore può riprovare di nuovo.
ACQUA NELLA VASCA	Una volta concluso un programma se il livello dell'acqua è di 0mm, sul display apparirà il messaggio "ACQUA NELLA VASCA". Verranno mostrate altre 2 opzioni "continuare" o "finalizzare". Se premiamo "continuare" verrà controllato di nuovo se il livello è 0mm. In caso affermativo, lo sportello si sbloccherà e l'errore scomparirà. Se premiamo "finalizzare" il programma conclude e lo sportello si sbloccherà.
NON C'È NESSUNA COMUNICAZIONE FRA LE SCHEDE	Quest'avviso appare all'interno del menù SAT della sezione dei Kit extra, quando si attiva un kit e non viene rilevata la comunicazione fra la scheda di comando principale e la scheda ausiliare. I kit attivi potranno essere disattivati senza comunicazione fra le schede, ma non sarà possibile attivarli.
VASCHE PIENE (T1/T2/T3)	L'avviso appare ogni volta che la vasca Tx è attiva in una fase di scarico e rileva che l'ingresso "Livello max. Vasca x" si è attivato. Non continuerà a scaricare a Tx e passerà allo scarico normale D1. Cicalino attivo per 10 secondi. L'avviso scompare quando si preme OK o mentre il tempo scorre.
VASCHE VUOTE (T1/T2/T3)	L'avviso appare ogni volta che la vasca Tx è attiva in una fase di riempimento e rileva che l'ingresso "Livello min, Vasca x" è stato attivato. Non continuerà a riempire da Tx e passerà a riempire dall'acqua fredda normale Cicalino attivo per 10 secondi. L'avviso scompare quando si preme OK o mentre il tempo scorre.
ASSENZA DI COMUNICAZIONE CON IL KIT DI PESATURA	L'avviso appare quando mentre viene attivato il kit di pesatura o si esegue la calibrazione, la scheda ausiliare è connessa e funziona correttamente, ma non si riesce a comunicare con l'apparecchio di pesatura. Non sarà possibile attivare il kit o eseguire una calibrazione.

CALIBRAZIONE DI PESATURA - GARANTIRE MACCHINA VUOTA	L'avviso appare quando si lancia una calibrazione del kit di pesatura, con lo scopo di informare l'utilizzatore che la lavatrice deve essere vuota, senza sopportare alcun peso, ecc...prima di lanciare una calibrazione. Nessuna. Avviso esclusivamente informativo. Tasto di "OK" per occultare l'avviso ed eseguire realmente la calibrazione.
CALIBRAZIONE DI PESATURA - OPERAZIONE IN CORSO	L'avviso appare mentre si esegue la calibrazione del sistema di pesatura. Nessuna. Avviso esclusivamente informativo. Non ha nessun tasto e apparirà per 5 secondi mentre si esegue la calibrazione.
CALIBRAZIONE DI PESATURA - CALIBRAZIONE ERRONEA	L'avviso appare ogni volta che mentre si finisce di eseguire la calibrazione, non è stato possibile azzerare correttamente il sistema di pesatura. Nessuna. Avviso esclusivamente informativo. Tasto di "OK" per occultare l'avviso.
CALIBRAZIONE DI PESATURA - RICHIESTA DI CALIBRAZIONE	L'avviso appare ogni volta che mentre premiamo il tasto "Start" per eseguire un programma di lavaggio misuriamo un peso minore di -3 kg o maggiore di 10 kg del nominale. Verranno mostrate altre 2 opzioni "Cancella" o "Ok". Se premiamo "OK" continuerà con il programma con il peso nominale. Se premiamo "cancella", il programma verrà annullato.
EASY LOAD - AVVIARE IL PROCESSO	L'avviso appare quando sullo schermo principale viene premuto il tasto di Easy Load. L'utilizzatore viene informato di inserire tutto il bucato e di chiudere lo sportello e gli verrà chiesto se vuole avviare il ciclo di Easy Load. Verranno mostrate altre 2 opzioni "Cancella" o "Ok". Se si preme "Cancel" il ciclo di Easy Load verrà annullato e si tornerà alla schermata di selezione. Se premiamo "OK" verrà avviato il ciclo di Easy Load.
EASY LOAD - CICLO IN CORSO	L'avviso appare mentre il ciclo di Easy Load è in corso, e l'utilizzatore viene informato che questo programma è iniziato. Non ha nessun tasto a disposizione. Messaggio esclusivamente informativo, l'utilizzatore non può fare altro che attendere il completamento del ciclo.
LOAD DETECTION	Tale avviso apparirà all'inizio del programma di lavaggio, quando l'opzione "pesatura intelligente" è attiva. Non ha nessun pulsante a disposizione. Avviso esclusivamente informativo. Quest'operazione può tardare diversi minuti.

Questi sono gli errori che possono verificarsi in una lavatrice:

ERRORE	DESCRIZIONE	CAUSA E AZIONE
E1	INTERRUZIONE DELLA FORNITURA DI ENERGIA ELETTRICA RILEVATO	Quest'errore appare quando viene ripristinata l'energia elettrica dopo un'interruzione durante l'esecuzione di un programma, la macchina ricomincerà dal programma interrotto automaticamente, e apparirà un messaggio di avviso per 30 sec. Verranno mostrate le opzioni "continuare" o "finalizzare". Se si preme continuare, continuerà dalla fase in cui si trovava al momento dell'interruzione della corrente, anche se dall'inizio della fase. Invece, se si preme "finalizzare" il programma conclude e lo sportello si sbloccherà.
E2	GUASTO NEL SISTEMA DI BLOCCO	Quest'errore appare all'inizio di un programma per non riuscire a bloccare la porta o a sbloccarla durante l'esecuzione di un programma. Il programma verrà portato a termine e si potrà riprovare, controllando che la porta è stata chiusa correttamente. Se il problema continua contattare il servizio tecnico.
E3	ERRORE NELLO SCARICO / ACQUA NELLA VASCA	Quest'errore appare quando la lavatrice non riesce a svuotare l'acqua dal cestello. Verranno mostrate due opzione "continua" o "finalizza" Controllare che l'uscita dello scarico non è ostruita. Se la macchina è fornita di una pompa di scarico, pulire il filtro.
E4	LIVELLO MASSIMO DI ACQUA RAGGIUNTO	Quest'errore appare quando la lavatrice rileva un livello d'acqua eccessivo. Controllare mentre nella lavatrice in pausa non entra acqua. Altrimenti, chiamare il servizio tecnico.
E5	GUASTO ENTRATA DELL'ACQUA	Quest'errore appare quando la lavatrice rileva il mancato ingresso dell'acqua. Prima di chiamare il servizio tecnico: Controllare che la valvola di intercettazione è aperta. Controllare la corretta configurazione dello scarico (valvola / pompa).
E6	GUASTO RISCALDAMENTO	Quest'errore appare quando la lavatrice non riesce a riscaldare l'acqua correttamente. Prima di chiamare il servizio tecnico, verificare che la configurazione di riscaldamento è quella corretta.
E7	TEMPERATURA MASSIMA SUPERATA	Quest'errore appare quando rileva una temperatura eccessiva. Apparirà solo l'opzione di "finalizzare"- Premendo tale opzione, il programma conclude, se la temperatura è inferiore a 50°. In caso contrario, apparirà l'errore E11: CAPI CALDI
E8	ERRORE DI MOVIMENTO	Quest'errore appare quando la lavatrice non rileva nessun movimento. Apparirà l'avviso "Il programma terminerà" e trascorsi 2 minuti verrà visualizzato il pulsante OK e se premuto il programma terminerà.

E9	SBILANCIAMENTO	Quest'errore appare quando la lavatrice non riesce ad equilibrare la biancheria. Cercare di caricare la biancheria in un modo più omogeneo.
E10	SBILANCIAMENTO MAX	Quest'errore appare quando la lavatrice rileva un movimento eccessivo durante la centrifuga. Se quest'errore appare improvvisamente, chiamare il servizio tecnico, potrebbe esserci un problema d'installazione e/o ammortizzazione.
E11	CAPI CALDI	Quest'errore appare quando alla fine di un programma, la temperatura all'interno della vasta è superiore ai 50°C (122°F). Attendere fino a quando la temperatura non si abbassa ai 50°C (122°F), e il programma finirà automaticamente.
E12	ERRORE SBLOCCO	Quest'errore appare quando la lavatrice non riesce a sbloccare la porta alla fine di un programma. Apparirà dopo 3 prove di sblocco ogni 20 secondi. Offrirà solo l'opzione di "finalizzare". La selezione di quest'opzione, consente di riprovarci, in caso contrario continuerà a mostrare errore. Non forzare la porta e chiamare il servizio tecnico, che vi consiglieranno come aprire la porta in modo sicuro.
E23	ERRORE NEL PESO	Quest'errore appare quando la lavatrice rileva un errore di comunicazione con il dispositivo di pesatura. Chiamare il servizio tecnico. Verranno mostrate le due opzioni "OK" o "Cancella". Se si preme "OK" verrà annullata l'esecuzione del programma e si tornerà a selezione. Se si preme "OK" si continuerà con l'esecuzione del programma con il valore del peso nominale della macchina.
E25	ERRORE DI COMUNICAZIONE CONTROLLO-CONTROLLO AUX	Quest'errore appare quando la lavatrice rileva un errore di comunicazione con la scheda ausiliare utilizzata in diversi accessori. Chiamare il servizio tecnico. Verranno mostrate le due opzioni "OK" o "Cancella". Se si preme "OK" verrà annullata l'esecuzione del programma e si tornerà a selezione. Se si seleziona "OK" si continua con l'esecuzione del programma ignorando la funzione dell'accessorio corrispondente.
E26	ERRORE DEL TERMICO MOTORE	Quest'errore appare quando la lavatrice rileva una temperatura eccessiva nel motore. Chiamare il servizio tecnico.
E27	ERRORE NTC FUORI RANGE	Quest'errore appare quando la lavatrice rileva una temperatura fuori portata. Il sensore della temperatura è disattivato o danneggiato. Chiamare il servizio tecnico. Verranno mostrate 2 opzioni "OK" o "Cancella". Selezionando "OK", continuerà con il programma ignorando il riscaldamento e premendo "Cancel", il programma verrà portato a termine.
E28	ERRORE SENSORE DI PRESSIONE FUORI RANGE	Quest'errore appare quando la lavatrice rileva un livello d'acqua fuori portata. Il sensore della pressione è disattivato o danneggiato. Chiamare il servizio tecnico. Quest'errore non avrà nessun pulsante a disposizione e potrà essere annullato solo spegnendo la macchina.

SELF SERVICE V2.0

6	INTRODUZIONE	35
7	INTERFACCE	35
7.1	Schermo di Selezione 1 - Tasti	35
7.2	Schermo di Selezione 2 - Pagamento.....	36
7.3	Impulso a moneta e "Credit mode"	36
7.4	Schermata di esecuzione	37
8	PROGRAMMI	38
8.1	Biblioteca dei programmi	38
9	CONFIGURAZIONE	39
9.1	Gestione dei programmi.....	39
9.2	Configurazione del sistema	39
9.2.1	Configurazione avanzata	39
9.2.2	Programmazione HUD	45
9.2.3	Tabella delle valute	47
10	MANUTENZIONE	49
10.1	Errori	49

6 INTRODUZIONE

In questa sezione vengono indicate le caratteristiche esclusive per le lavatrici self service. È obbligatorio leggere le avvertenze di sicurezza ed è necessario leggere il resto del manuale per una completa comprensione del funzionamento.

7 INTERFACCE

7.1 Schermo di Selezione 1 - Tasti

Quando la macchina viene accesa appare la *Schermata selezione 1*. In questa schermata avremo a disposizione 4 tasti grandi fissi che ci consentiranno di selezionare i programmi di lavaggio.



1. **Identificatore della macchina:** mostra l'etichetta che identifica l'apparecchio in base alla configurazione esistente (se è stata abilitata).
2. **Orario:** appare l'orario attuale nel formato selezionato dall'utilizzatore.
3. **Nome del programma:** nome configurato per il programma selezionato.
4. **Nome del programma:** durata, in minuti, stimata per il programma selezionato.
5. **Temperatura programma:** temperatura massima fra le diverse fasi che possiede il programma.
6. **Prezzo:** solo nella modalità Coin, in quella CP e CR non apparirà il prezzo e al suo posto apparirà un led.
7. **Numero dei programmi:** mostra il numero dei programmi visualizzati e il numero dei programmi disponibili. Sullo schermo appariranno un massimo di 4 programmi e il numero massimo di programmi da mostrare è di 16 (4 schermate di 4 pulsanti).
8. **Frecce laterali di navigazione:** nel caso in cui si hanno più di 4 programmi fra i favoriti, appariranno le frecce di navigazione laterali, che consentono di mostrare la seguente schermata di selezione.

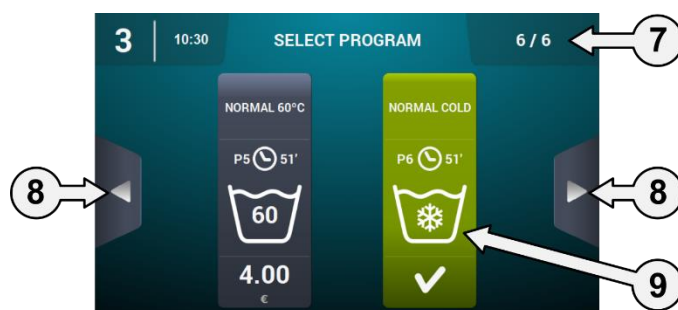

9. **Pulsante attivo:** su questa prima schermata sarà possibile eseguire il pagamento. Una volta raggiunto l'importo di un programma, il prezzo scomparirà e si accenderà il led che indica che il programma è abilitato per essere eseguito.

Se si preme il tasto di un programma si passerà alla "Schermata di selezione 2 – Pagamento".

Alla fine dell'esecuzione di un programma, si passerà a questa schermata.

Inoltre, anche se è stato toccato lo schermo oppure si è cominciato a inserire il denaro, in caso di mancata attività per 15 minuti, si tornerà direttamente a questa schermata, azzerando l'importo eventualmente inserito.

7.2 Schermo di Selezione 2 - Pagamento

Questa schermata ci fornirà le stesse informazioni avute da quella precedente, ma solo del programma selezionato e seguito da animazione e testo di aiuto. Inoltre, avremo a disposizione dei tasti di navigazione per modificare il programma.

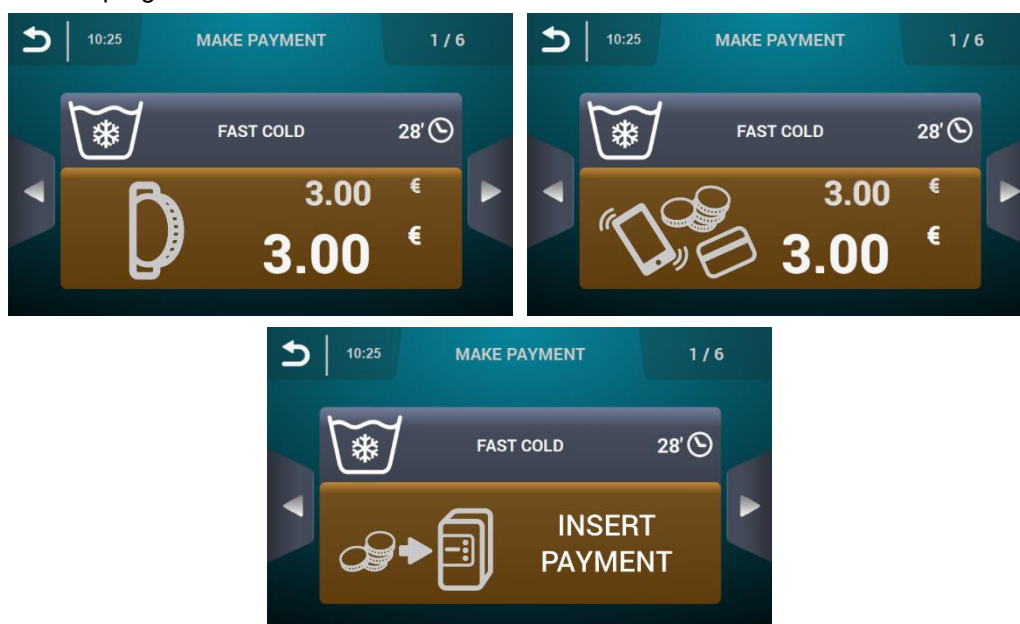

Il pulsante apparirà in marrone fino a quando non verrà inserito l'importo indicato nel programma.

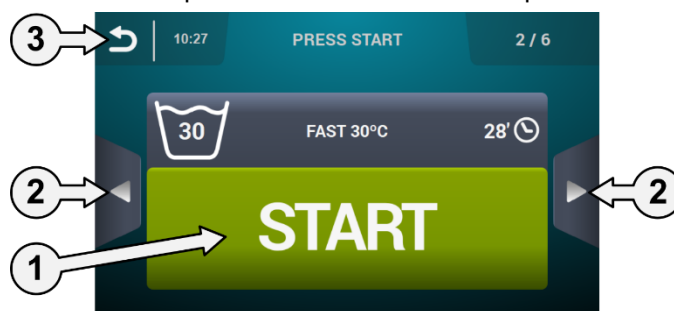

1. **Pulsante Start:** una volta raggiunto l'importo del programma, apparirà un pulsante grande di "Start" in verde.
2. **Pulsante di navigazione:** ci consente di cambiare di programma.
3. **Pulsante indietro:** premendo questo pulsante, si torna alla schermata principale "Selezione 1 - Pulsanti".

Se dopo essere trascorsi 15 minuti non si è verificata alcuna attività, l'importo inserito verrà azzerato e il denaro perduto e si tornerà alla schermata di "Selezione 1 – Pulsanti".

Se si preme il tasto "Start" si comincerà ad eseguire il programma selezionato.

7.3 Impulso a moneta e "Credit mode"

Per la realizzazione di qualsiasi programma, è necessario abbonare prima il pagamento corrispondente. A questo proposito, a seconda della configurazione del self-service presente, controllare l'inserimento delle monete (modalità COIN) oppure il ricevimento del segnale corrispondente nella modalità CP o Pagamento multiple, dalla voce "micro gettoniera" per consentire l'esecuzione del programma selezionato.

Nella modalità di self-service (sulla schermata di selezione 1 e 2, o mentre è in corso un programma di self-service), è presente l'opzione per accedere alla modalità "Credit mode". Se viene attivato l'ingresso "ripiano aperto" nei modelli industriali o viene attivato il codice della gettoniera o CP dei modelli professionali, verrà richiesta la password per entrare su "Credit mode".

Se si entra in "Credit mode, si esce automaticamente dalla modalità self service e si comporta come se si trovasse nella modalità normale, mostrando le informazioni definite nella *Schermata principale* OPL e offrendo la possibilità di eseguire tutte le azioni definite in tale schermata. Verranno mostrati i programmi selezionati per il self service e i programmi definiti per il Credit Mode.

Quando si accede al menù principale, verranno visualizzate tutte le opzioni disponibili per le lavatrici self service.

Se viene disattivato l'ingresso "ripiano aperto" nei modelli industriali o viene attivato il codice della gettoniera o CP dei modelli professionali, si esce da "Credit mode" automaticamente. Se ci troviamo in una schermata secondaria del menù principale (configurazione, manutenzione...) e si esce da "Credi Mode", si comporterà come se si trovasse in questa modalità fino ad uscire dalla Schermata principale (salvando le modifiche). Una volta raggiunta la Schermata principale, si esce da credit mode.

7.4 Schermata di esecuzione

Dopo aver premuto il pulsante START, il programma viene avviato e sul display compare la *Schermata di esecuzione*.

Mentre è in esecuzione, vi è anche la possibilità di entrare in "Credit mode" nello stesso modo spigato prima. Se si entra in "Credit mode, si esce automaticamente dalla modalità self service e si comporta come se si trovasse nella modalità OPL, mostrando le informazioni definite nella *Schermata esecuzione OPL* e offrendo la possibilità di eseguire tutte le azioni definite in tale schermata.

Nella modalità self service non è presente l'opzione di avanzare di fase o mettere in pausa il programma salvo quando si entra nella modalità "Credit mode".

Inoltre non sarà presente neanche il pulsante STOP che consente di cancellare un programma, anche se può essere attivato tramite l'HUD.

Nel caso di attivare il tasto STOP, è presente un periodo di proroga durante il quale è possibile annullare un programma senza perdere il credito inserito. Se si interrompe per una seconda volta all'interno di questo periodo di dilazione, il credito verrà perduto.

Per annullare il programma, una volta trascorso il periodo di proroga, sarà necessario tenere premuto il tasto per circa 3 secondi e si perderà il credito.

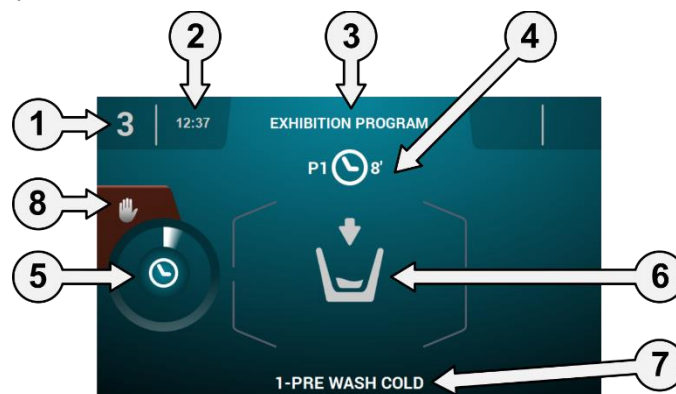

1. **Identificatore della macchina:** etichetta di identificazione della macchina
2. **Ora:** Ore e minuti nel formato selezionato.
3. **Nome del programma:** nome configurato per il programma selezionato.
4. **Numero e durata del programma:** posizione del programma nell'elenco dei programmi (I miei programmi), e la durata, in minuti, stimata per il programma selezionato.
5. **Indicatore di progresso del programma:** stato del progresso del programma, rapporto fra il tempo totale e il tempo residuo del programma.
6. **Stato (disegno):** disegno animato che mostra cosa sta facendo la lavatrice (riempimento, scarico, lavaggio, risciacquo, centrifuga o anti-impetramento).
7. **Fase in esecuzione:** identificatore e nome della fase in esecuzione
8. **Stop:** (disattivato per difetto): pulsante per arrestare il programma. Verrà richiesto il messaggio di conferma.

8 PROGRAMMI

È presente una biblioteca di programmi composta da tutti i programmi che possiede per difetto, così come i programmi creati dall'utente stesso.

8.1 Biblioteca dei programmi

Questi sono i programmi che verranno inseriti nella biblioteca dei programmi per difetto:

- P1: Rapido freddo
- P2: Rapido 30°C (86°F)
- P3: Rapido 60°C (140°F)
- P4: Rapido delicati

P1					
	8	2	2	2	6
	1	3	3	3	
	3	3	3	3	4
	0	0	0	0	
	15;05	15;05	15;05	15;05	
	✓	✓	✓	✓	
	✓	✓	✓	✓	
	✓	✓	✓	✓	
					✓
					✓
D	D2, D3			D4, D5	

P2					
	8	2	2	2	6
	30				
	1	3	3	3	
	3	3	3	3	4
	1	0	0	0	
	15;05	15;05	15;05	15;05	
	✓	✓	✓	✓	
	✓	✓	✓	✓	
	✓	✓	✓	✓	
					✓
					✓
D	D2, D3			D4, D5	

P3					
	8	2	2	2	6
	60				
	1	3	3	3	
	3	3	3	3	4
	1	0	0	0	
	15;05	15;05	15;05	15;05	
	✓	✓	✓	✓	
	✓	✓	✓	✓	
	✓	✓	✓	✓	
					✓
					✓
D	D2, D3			D4, D5	

P4					
	8	2	2	2	6
	2	4	4	4	
	2	2	2	2	3
	0	0	0	0	
	08;06	08;06	08;06	08;06	
	✓	✓	✓	✓	
	✓	✓	✓	✓	
	✓	✓	✓	✓	
					✓
					✓
D	D2, D3			D4, D5	

9 CONFIGURAZIONE

9.1 Gestione dei programmi

Nel caso in cui la lavatrice è stata configurata nella modalità self service, saranno disponibili solo i primi 16 programmi, mentre il resto sarà disponibile quando si passerà alla modalità Credit Mode.







9.2 Configurazione del sistema

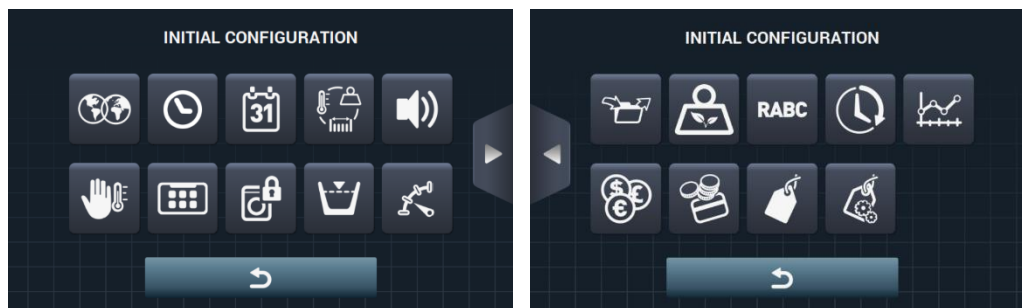





9.2.1 Configurazione avanzata

Accesso: [Schermata principale]  → [Menù Principale] 

Nella configurazione del sistema, è possibile configurare le seguenti sezioni, così come per "Credit mode" (Vedi sezione 4.2):



- ▶ **Schermata successiva.**
- ◀ **Schermata precedente.**
-  **Lingua:** i testi della lavatrice possono essere visualizzati in 34 lingue diverse, anche se la modifica dei testi può essere realizzata utilizzando solo caratteri occidentali.
-  **Ora:** configurazione dell'ora attuale. È consentito selezionare il formato di visualizzazione 12 ore / 24 ore (per difetto).
-  **Data:** configurazione della data attuale. È consentito selezionare il formato di visualizzazione (gg/mm/aaaa (per difetto) / aaaa/mm/gg / mm/gg/aaaa).
-  **Unità di misura:** consente la selezione dell'unità di misura con la quale si preferisce visualizzare la temperatura (°C (per difetto) o °F), il peso (Kg (per difetto) o Lb) e la dimensione (mm (per difetto) o in).
-  **Arresto termico:** configurazione generale dell'arresto termico. Quando è abilitato, non si verificherà alcun arresto termico, anche quando nella fase in esecuzione tale parametro è attivo. Invece, se è stato attivato, verrà rispettata la configurazione di ogni fase e si agirà di conseguenza. Per difetto, attivo.
-  **Risparmio idrico nel peso:** è consentito configurare il risparmio idrico preferito per il peso, scegliendo fra 3 opzioni diverse di peso e 3 livelli di risparmio. Secondo il carico, la riduzione dell'acqua e il dosaggio del detersivo variano.
-  **Livelli:** consente la configurazione in mm dei 5 livelli configurabili. Ogni tipo di livello avrà un valore per difetto e un range di configurazione, valori che dipendono dal modello selezionato. (Consulta la tabella dei livelli per modello).

- 
Velocità: consente la configurazione in GIRI dei diversi tipi di velocità presenti, sia nel lavaggio sia nella centrifuga. Ogni tipo di velocità avrà un valore di configurazione minimo e massimo. (Consulta la tabella delle equivalenze RPM/V per modello).
- 
Importa/Esporta configurazione: consente di importare dalla memoria USB una configurazione della macchina o esportare a una memoria USB la configurazione attuale della macchina. Quando si preme questo pulsante, apparirà una schermata intermedia per selezionare l'importazione o l'esportazione (come nei programmi).
- 
Credit Mode: Si la lavadora está en modo autoservicio, se podrá configurar la contraseña para Credit Mode (1234 por defecto). Anote la contraseña y gúardela, si lo pierde póngase en contacto con el servicio de asistencia técnica.
- 
HUD: Anche quando ci troviamo nella modalità di self-service sarà possibile configurare la *Schermata principale* (la prima e la seconda schermata di selezione) e la *Schermata di esecuzione*. (Vedi la sezione 9.2.2).
- 
Beep: opzione che consente disattivare il cicalino. Per difetto, attivato..
- 
RABC/Tracciabilità: le informazioni di ogni lavaggio verranno memorizzate e salverà le seguenti informazioni (Vedi sezione 4.2).
- 
Periodo di proroga: ogni volta che viene premuto questo tasto appare una schermata intermedia per attivare o disattivare il periodo di proroga e modificare il valore compreso fra 1 e 99 minuti (per difetto attivato a 1 minuto).

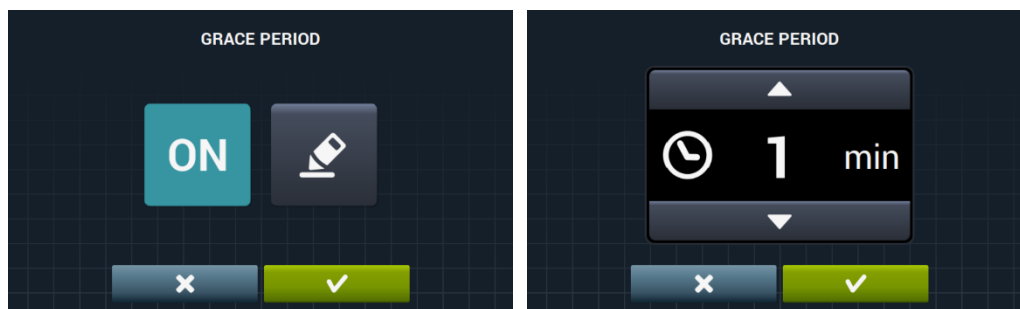

- 
Statistiche di self-service: consente di ottenere i dati di riscossione e il numero di esecuzione per ciascuno dei programmi preferiti. Se si preme il tasto delle statistiche di self-service, appare la seguente schermata.

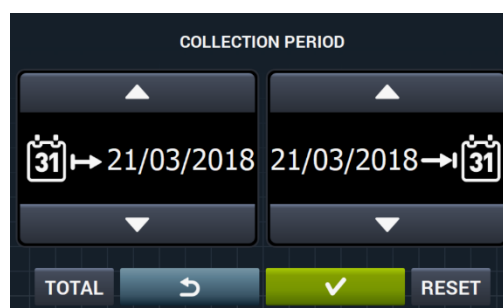

Se si preme su "TOTAL", verranno mostrati i valori complessivi della macchina. Se si inserisce una data, verranno mostrate le statistiche relative esclusivamente a questo periodo. Premendo "Reset", tutti i valori verranno inseriti su 0, e le statistiche azzerate.

EXECUTIONS AND COLLECTED MONEY		
1 FAST COLD	0	0.00€
2 FAST 30°C	0	0.00€
3 FAST 60°C	0	0.00€
4 FAST DELICATE	0	0.00€
TOTAL	0	0.00€

- Valuta:** consente di selezionare il tipo di valuta con la quale si vuole operare e modificare il corrispondente valore di pulsazione (vedi sezione 9.2.3). Se si modifica la valuta, tutti i prezzi verranno ripristinati, per difetto a token.

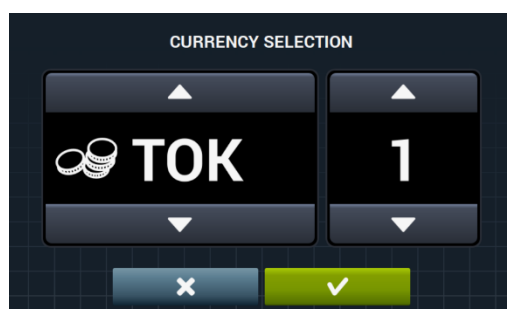

- Modalità di pagamento:** sono state impostate 3 diverse modalità per operare nella modalità self service.

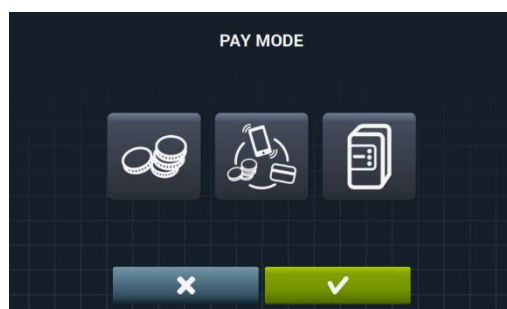



- COIN:** sarà necessario configurare la valuta e il prezzo di ogni programma, agendo sugli impulsi della gettoniera per attivare l'esecuzione di un determinato programma.
- Central Payment:** la lavatrice riceverà un impulso da una centralina di pagamento per liberare la lavatrice e consentire l'esecuzione di un programma. Selezione per difetto. Le opzioni di valuta, prezzo e programmazione dei prezzi saranno disattivate.
- Pagamento multiple:** comportamento identico all'opzione "COIN".

- Prezzi:** è possibile configurare i prezzi di tutti i programmi selezionati in "I miei programmi". Il valore minimo del programma sarà il multiplo definito nella valuta, invece il massimo sarà 100 volte il valore del multiplo. Per difetto, il valore minimo configurabile.

ASSIGN PRICES	
1 FAST COLD	3.00 €
2 FAST 30°C	4.00 €
3 FAST 60°C	5.00 €
4 FAST DELICATE	3.00 €

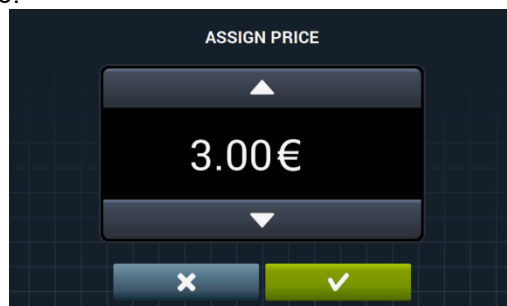
Selezionare il programma o i programmi da modificare e premendo il pulsante  passiamo alla finestra per l'assegnazione del nuovo prezzo.



-  **Programmazione dei prezzi:** oltre alla configurazione di base dei prezzi, esiste la possibilità di realizzare una programmazione dei prezzi, ossia, periodi di tempo concreti nei quali si vuole modificare il prezzo definito dei programmi. Massimo, 10 programmazioni simultanee.

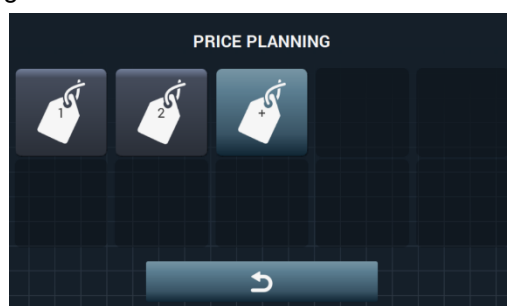

I prezzi programmati saranno validi nella tranche oraria configurata, e si tornerà ai prezzi generali una volta finalizzato l'orario configurato.

Se si verifica un conflitto fra le diverse programmazioni, verrà applicata la condizione del primo piano. Inoltre, è consentito creare piani solo a partire dalla data attuale.

Premendo il pulsante  viene creato un nuovo piano. Questi saranno i campi da compilare per creare una programmazione:

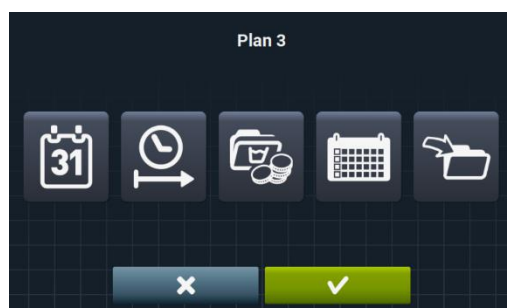

-  **Data:** periodo di tempo in cui si vuole realizzare la programmazione.

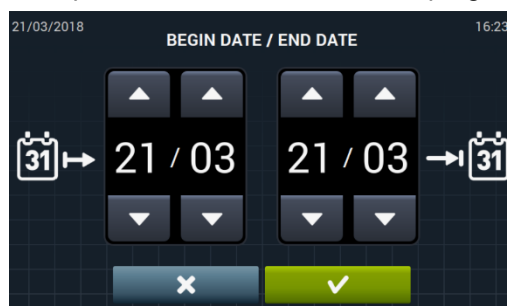

-  **Ora inizio/fine:** ora di inizio e ora finale della programmazione realizzata.

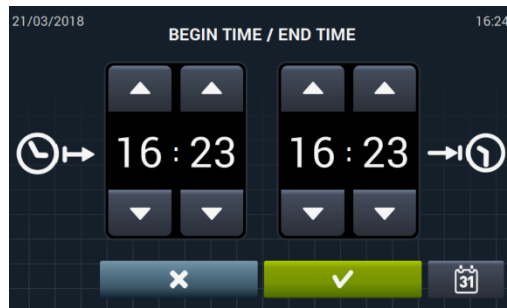

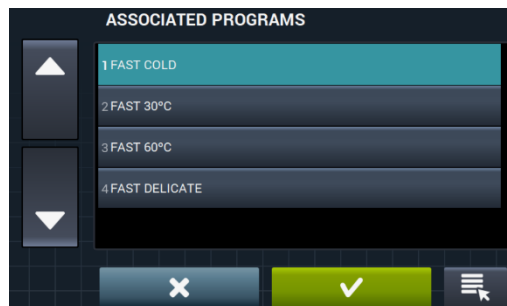

- 
Programma(i) & Prezzi: prezzo o sconto da assegnare a ciascuno dei programmi esistenti in "I miei Programmi". Sarà consentito assegnare un prezzo fisso o applicare uno sconto ai programmi selezionati.

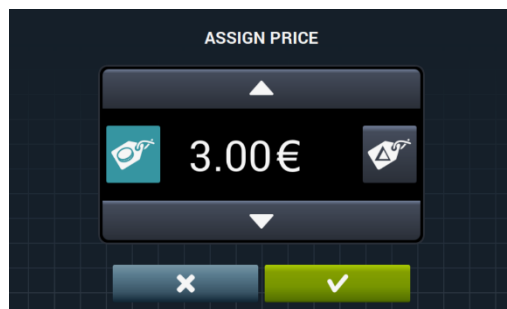

A tal fine, selezioniamo il o i programmi ai quali vogliamo applicare la modifica di prezzo e verrà premuto accettare.



- 
Prezzo fisso: il prezzo definito verrà applicato a tutti i programmi selezionati.
- 
Sconto: lo sconto definito verrà applicato a tutti i programmi selezionati.
- 
Calendario: all'interno della data indicata, i giorni in cui si vuole applicare la programmazione realizzata.

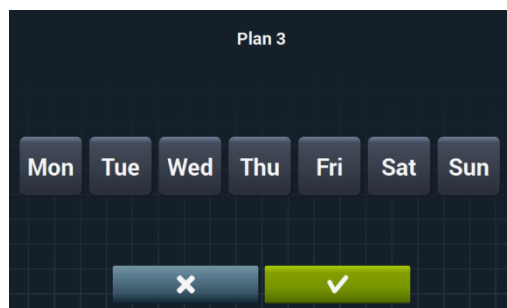

- 
Importa: oltre a inserire tutti i campi uno per volta, vi è la possibilità di importare un piano esistente dalla memoria USB.

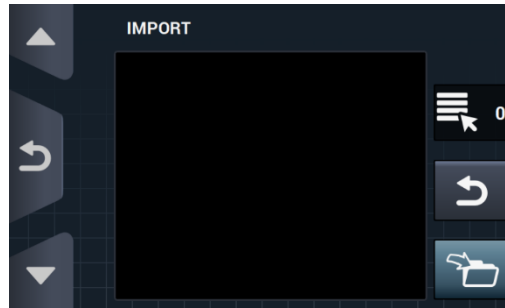

Se viene selezionato IMPORTA, apparirà la stessa schermata di programmi per navigare nell'USB, anche se potranno essere selezionati solo i file dei piani di prezzo (estensione .plan). Per l'importazione, è consentito importare solo un piano. Se si preme OK e importa il piano, si torna alla schermata principale dei piani dei prezzi.

La selezione del pulsante corrispondente a uno dei piani attivi , mostrerà un riepilogo dei parametri configurati.

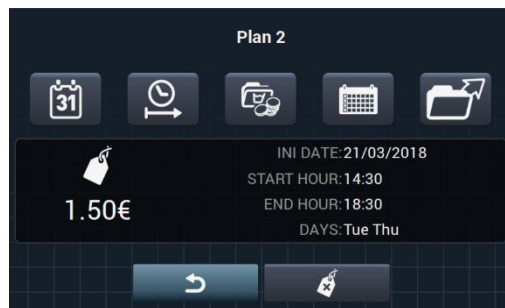

È possibile modificare i parametri descritti sopra uno per volta selezionando il pulsante corrispondente.

Inoltre è presente il pulsante "Esporta"  per esportare questo piano (in un file con l'estensione .plan) alla directory radice della memoria USB.

I file relativi ai piani di prezzo verranno salvati in una cartella dal nome "PRICE PLANS" nella directory radice dell'unità flash USB.

Ogni file dei piani di prezzo verrà chiamato nel seguente modo: PLAN_N°_Data_Ora.piano (PIANO_3_20151029_112346.piano per esempio).

Il piano può essere eliminato, selezionando il pulsante di cancella .

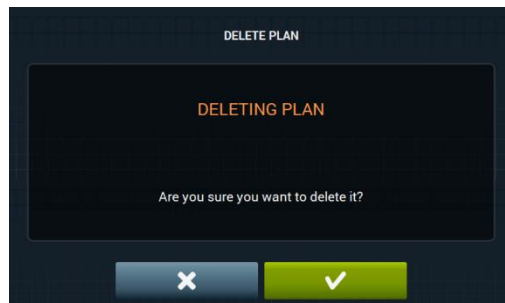

9.2.2 Programmazione HUD

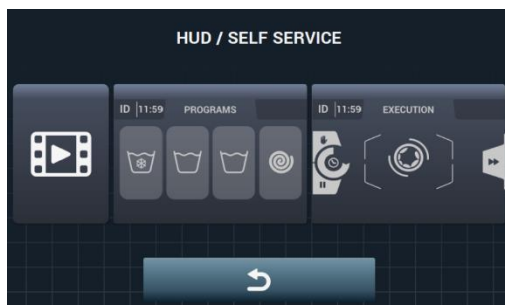



-  **Schermata principale:** può essere applicato su entrambe le schermate di selezione di self-service. Consente la configurazione dei seguenti parametri:



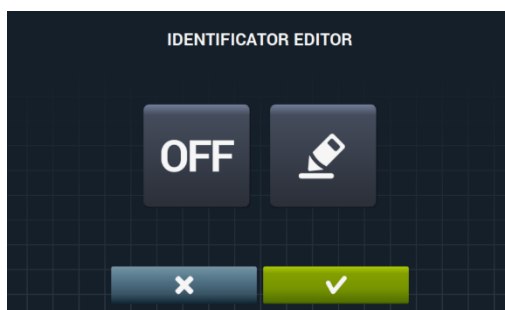

-  **Identificatore della macchina:** è possibile attivare/disattivare e configurare l'identificazione della macchina. Per difetto, disattivato.



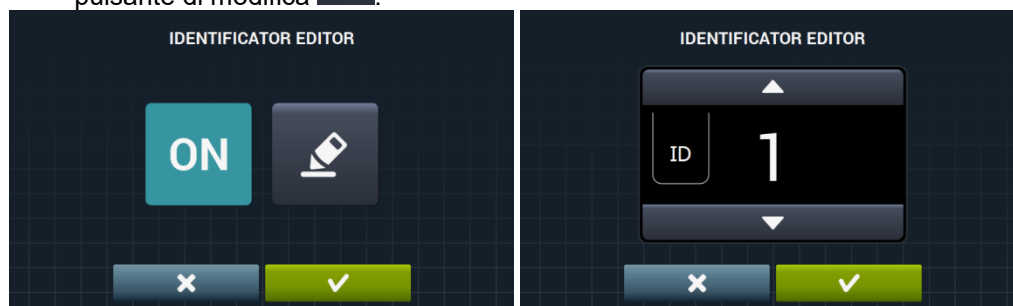



L'identificatore della macchina può essere attivato premendo il pulsante "OFF"  e poi il pulsante di modifica .





-  **Ora:** Mostra/nascondi ora attuale. Per difetto, attivato.

-  **Schermata di esecuzione:** di seguito verranno mostrate le opzioni configurabili:

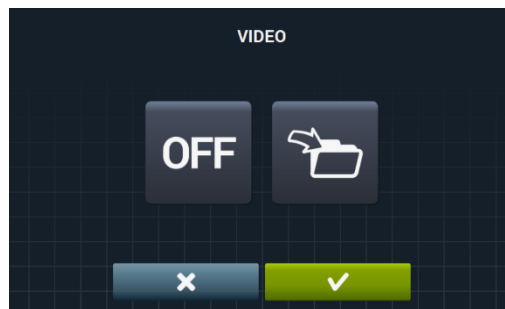

-  **Ora:** opzione che consente di mostrare/nascondere l'ora. Per difetto, attivato.
-  **Tempo restante:** opzione per mostrare/nascondere il tempo residuo totale e l'indicatore di progresso del programma. Per difetto, attivato.
-  **Identificatore della macchina:** è consentito attivare/disattivare l'identificazione della macchina. Per difetto, disattivato.
-  **STOP:** consente di mostrare il pulsante di arresto. Per difetto, disattivato.
-  **Importa video:** può riprodurre un video sulla schermata della macchina dopo 10 minuti di inattività. Se si attiva il "Risparmio energetico" automaticamente, verrà disattivata la riproduzione del video.



Facendo clic sul pulsante di importa , può essere importato un video alla macchina da una memoria USB esterna, possono essere importati solo file di video (avi, mov,...), e sarà possibile conservare un file del video installato nella macchina. La risoluzione dei video sarà, per le macchine con uno schermo di 4,3" di 480x272 pixel, e per le macchine con uno schermo di 7" di 800x480 pixel. Non si consiglia che superi 16 Fps. La dimensione massima del file non deve superare i 25Mb.

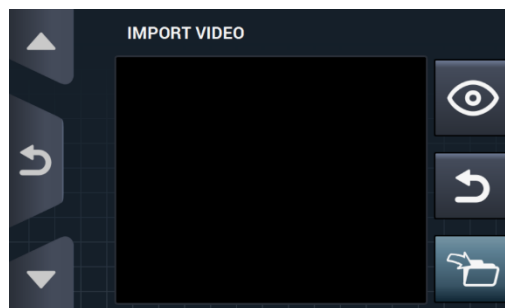

Il pulsante di pre-visualizzazione , ci consente di verificare la corretta riproduzione del file di video.

9.2.3 Tabella delle valute

Questa è la tabella di tutte le monete disponibili con il simbolo corrispondente e l'impulso (multiplo). Se si sceglie un valore di pulsazione diverso da quello per difetto, sarà necessario adeguare la gettoniera a questo valore. È responsabilità dell'utente compiere tale operazione. Per difetto le gettoniere fornite hanno questi valori configurati:

PAESE	MONETA	ISO	SIMBOLO	Valore/IMPULSO
Token	Token	TOK	\$	1
Kuwait	Dinar Kuwaitiano	KWD	ك.د.	0,05
Oman	Rial dell'Oman	OMR	ر.ع.	
Azerbaijan	Manat	AZN	m	0,1
Bulgaria	Lev	BGN	лв	
Bahrain	Dinar Bahrain	BHD	ب.د.	
Cina	Yuan cinese	CNY	¥	
Malesia	Ringgit malese	MYR1	RM	
Panama	Panamense	PAB	B	
Argentina	Peso argentino	ARS	\$	
Bermuda	Dollaro delle Bermuda	BMD	BD\$	0,25
Brasile	Reale	BRL	R\$	
Canada	Dollaro canadese	CAD	C\$	
Egitto	Sterlina egiziana	EGP	ج.م.	
Etiopia	Birr dell'Etiopia	ETB	Br	
Guatemala	Quetzal del Guatemala	GTQ	Q	
Isole Cayman	Dollaro delle isole Cayman	KYD	\$	
Arabia Saudita	Riyal dell'Arabia Saudita	SAR	ر.س.	
El Salvador	Dollaro di El Salvador	SVC	¢	
Turchia	Lira turca	TRY	YTL	
Stati Uniti	Dollaro statunitense	USD	\$	
Emirati Arabi Uniti	Dirham degli EAU	AED	إ.د.	0,5
Bolivia	Boliviano	BOB	Bs	
Estonia	Corona dell'Estonia	EEK	EEK	
Paesi europei	Euro	EUR	€	
Regno Unito	Scellino sterlina	GBP	£	
Georgia	Lari	GEL	ლარი	
Ghana	Cedi del Ghana	GHS	GHS	
Croazia	Kuna croata	HRK	kn	
Nuova Zelanda	Dollaro neozelandese	NZD	\$	
Qatar	Riyal del Qatar	QAR	ق.ر.	
Ucraina	Grivna dell'Ucraina	UAH	\$	
Singapore	Dollaro di Singapore	SGD	S\$	
Malesia	Ringgit malese	MYR2	RM	

Boznia ed Herzegovina	Marco convertibile	BAM	KM	1
Bangladesh	Taka del Bangladesh	BDT	Tk	
Svizzera	Franco svizzero	CHF	CHF	
Repubblica Dominicana	Peso dominicano	DOP	RD\$	
Hong Kong	Dollaro di Hong Kong	HKD	HK\$	
Israele	Shekel israeliano	ILS	₪	
India	Rupia indiana	INR	Rs.	
Sri Lanka	Rupia dello Sri Lanka	LKR	₹	
Marocco	Dirham marocchino	MAD	م.د.	
Macedonia	Dinar della Macedonia	MKD	MKD	
Perù	Nuevo Sol peruviano	PEN	S/.	
Polonia	Zloty polacco	PLN	zł	
Russia	Rublo Russo	RUB	руб	
Svezia	Corona svedese	SEK	kr	
Tailandia	Baht thailandese	THB	฿	
Tunisia	Dinar tunisino	TND	ت.د.	
Uruguay	Peso uruguayano	UYU	\$	
Serbia	Dinar serbio	RSD	дин.	
Sudafrica	Rand sudafricano	ZAR	R	
Australia	Dollaro australiano	AUD	\$	
Repubblica Ceca	Corona ceca	CZK	Kč	5
Danimarca	Corona danese	DKK	kr	
Kenya	Scellino keniota	KES	KSh	
Messico	Peso messicano	MXN	\$	
Norvegia	Corona norvegese	NOK	kr	
Romania	Leu romeno	RON	L	
Filippine	Peso filippino	PHP	\$	
Algeria	Dinar algerino	DZD	د.ج.	10
Guyana	Dollaro della Guyana	GYD	GY\$	
Ungheria	Fiorino ungaro	HUF	Ft	
Islanda	Corona islandese	ISK	kr	
Kazakistan	Tengue kazako	KZT	T	
Taiwan	Dollaro taiwanese	TWD	NT\$	
Cile	Peso cileno	CLP	\$	
Costa Rica	Colon del Costa Rica	CRC	₡	50
Iran	Rial iraniano	IRR		
Paraguay	Guarani del Paraguay	PYG	\$	
Polinesia Francese	Franco CFP	XPF	F	
Colombia	Peso colombiano	COP	\$	100
Indonesia	Rupia indonesiana	IDR	Rp	
Giappone	Yen giapponese	JPY	¥	
South Korea	Won coreano	KRW	₩	
Uganda	Scellino ugandese	UGX	USh	
Venezuela	Bolivar	VEF	Bs.	

10 MANUTENZIONE

10.1 Errori

Di seguito vengono indicati gli errori che provocano azioni distinte per il Self service, per il resto sono uguali.

ERRORE	DESCRIZIONE	CAUSA E AZIONE
E6	GUASTO RISCALDAMENTO	Si rileva che, nonostante sia stata abilitata l'uscita di riscaldamento, la temperatura dell'acqua non è aumentata per 30 minuti. È possibile annullare quest'errore. In questo caso, invece di indicare l'errore, andrà avanti come se avesse raggiunto la temperatura. Apparirà un avviso ma non si fermerà, continuerà con il programma anche se l'avviso resterà attivo fino a quando il programma non finisce e si aprirà lo sportello.
E9	SBILANCIAMENTO	Nella distribuzione della centrifuga finale viene attivata 5 volte la voce "Interruttore sbilanciamento". Non indicherà l'errore e continuerà a centrifugare a una bassa velocità, il programma conclude normalmente senza avvisi.

AVISOS DE SEGURANÇA.....	2
1 UTILIZAÇÃO	5
1.1 Recomendações de utilização	5
1.2 Uso do doseador.....	5
1.3 Características da máquina	5
2 INTERFACE.....	6
2.1 Ecrã OFF OPL.....	6
2.2 Ecrã principal OPL.....	6
2.3 Ecrã execução OPL	7
3 PROGRAMAS	10
3.1 Parâmetros de fase.....	10
3.1.1 Parâmetros para fases de molho, pré-lavagem, lavagem ou enxaguamento:10	
3.1.2 Parâmetros para fases de centrifugação:	12
3.2 Biblioteca de fases	13
3.3 Biblioteca de programas	15
4 CONFIGURAÇÃO	16
4.1 Gestão de programas	17
4.1.1 Os meus programas (favoritos).	17
4.1.2 Biblioteca de programas	18
4.1.3 Biblioteca de fases.....	21
4.2 Configurar Sistema.....	22
4.2.1 Configuração HUD.....	26
5 MANUTENÇÃO	30
5.1 Irregularidades elétricas e mecânicas	30
5.2 Avisos	30

AVISOS DE SEGURANÇA

Para reduzir o risco de descargas elétricas ou danos pessoais ao utilizar o aparelho, siga as precauções básicas, incluindo as seguintes:

- **LEIA** todas as instruções antes de utilizar o aparelho e **GUARDE-AS** num local de fácil acesso para resolver qualquer dúvida.
- **NÃO** lave roupas que não tenham sido previamente tratadas, lavadas, colocadas de molho ou manchadas com gasolina, dissolventes de limpeza a seco ou outras substâncias inflamáveis ou explosivas, dado que soltam vapores que podem incendiar-se ou explodir.
- **NÃO** adicione gasolina, dissolventes de limpeza a seco ou outras substâncias inflamáveis à água de lavagem. Essas substâncias soltam vapores que podem incendiar-se ou explodir.
- Em determinadas condições, pode ser produzido gás de hidrogénio num sistema de água quente que não seja utilizado durante duas ou mais semanas. O gás de hidrogénio é explosivo. Se o sistema de água quente não tiver sido utilizado durante algum tempo, antes de utilizar a máquina de lavar, abra as torneiras de água quente e deixe que a água escorra durante vários minutos. Desta forma, o gás de hidrogénio acumulado será libertado. Como o gás é inflamável, não fume nem faça chamas durante este período.
- Este aparelho pode ser utilizado por crianças com 8 ou mais anos de idade e pessoas com capacidades físicas, sensoriais ou mentais reduzidas ou com falta de experiência e conhecimentos, se forem supervisionadas ou receberem formação adequada relativamente ao uso do aparelho de uma maneira segura e compreenderem os perigos que ele implica. A limpeza e a manutenção a realizar pelo utilizador não devem ser feitas por crianças sem supervisão.

- NÃO permita que crianças brinquem em cima do aparelho. Mantenha as crianças debaixo de vigilância apertada quando estiverem nas proximidades de uma máquina em funcionamento. As crianças com menos de 3 anos deverão manter-se longe do aparelho a não ser que estejam sob supervisão contínua.
- Tire a porta antes de descartar o aparelho ou colocá-lo fora de serviço.
- NÃO TENHA ABRIR A PORTA se o tambor estiver em movimento.
- NÃO instale nem armazene o aparelho ao ar livre.
- NÃO tente forçar os controlos.
- Devem ser utilizados tubos flexíveis novos fornecidos com o aparelho e não os tubos flexíveis antigos.
- Não repare nem substitua qualquer peça do aparelho nem tente qualquer operação de serviço, a menos que esta seja recomendada no manual de instruções do utilizador. Mesmo assim, certifique-se sempre de que compreende perfeitamente as instruções e de que possui a capacidade necessária para levar a cabo a operação.
- NÃO elimine nenhum dispositivo de segurança nem modifique nenhum elemento da máquina de lavar. NÃO INSTALE no interior da máquina elementos alheios a ela.
- Qualquer omissão das indicações descritas nos manuais de instruções pode dar origem a danos pessoais ao utilizador. Não é possível abranger todas as condições e situações possíveis com os avisos de perigo e as advertências. Por isso, o senso comum, a precaução e o cuidado são fatores que devem ser tidos pelas pessoas que transportem, instalem, utilizem ou façam a manutenção da máquina.
- NÃO utilize a máquina sem que todas as tampas e proteções estejam corretamente colocadas e fixadas.

- É OBRIGATÓRIO o distribuidor (vendedor) dar informações corretas ao utilizador durante a colocação em funcionamento.
- Coloque nas cuvetes correspondentes as doses de detergente, amaciador e lixívia indicadas pelo fabricante. Respeite os conselhos de tratamento de cada tecido indicados pelo respetivo fabricante.
- Limpe diariamente as cuvetes de detergente e líquidos. Utilize água e sabão na limpeza, nunca detergentes abrasivos.
- Limpe mensalmente os filtros das entradas de água e as condutas de doseamento exteriores.
- Nunca lave o exterior com jato de água; as peças funcionais da máquina podem ficar danificadas.
- Se a máquina de lavar não for utilizada durante um longo período, aplique óleo de vaselina em todas as superfícies de aço inoxidável.
- Recomenda-se que faça uma revisão geral anual.

1 UTILIZAÇÃO

1.1 Recomendações de utilização

Esta máquina foi desenhada e concebida para lavagem e tratamento de têxteis em geral. A sua utilização para fins diferentes aos indicados será considerada como indevida e perigosa.

É aconselhável carregar a máquina à sua carga nominal, evitando meter cargas muito inferiores ou superiores.

Não é aconselhável lavar roupa dentro de sacos; neste caso, encha a máquina de lavar até à sua carga nominal para evitar possíveis desequilíbrios da carga.





Não é aconselhável centrifugar lonas ou roupas impermeáveis, mopas, alcatifas ou tapetes.

Antes de tentar abrir a porta, espere até que o tambor tenha parado. Por motivos de segurança, a porta só é desbloqueada alguns segundos depois de ter terminado o programa.

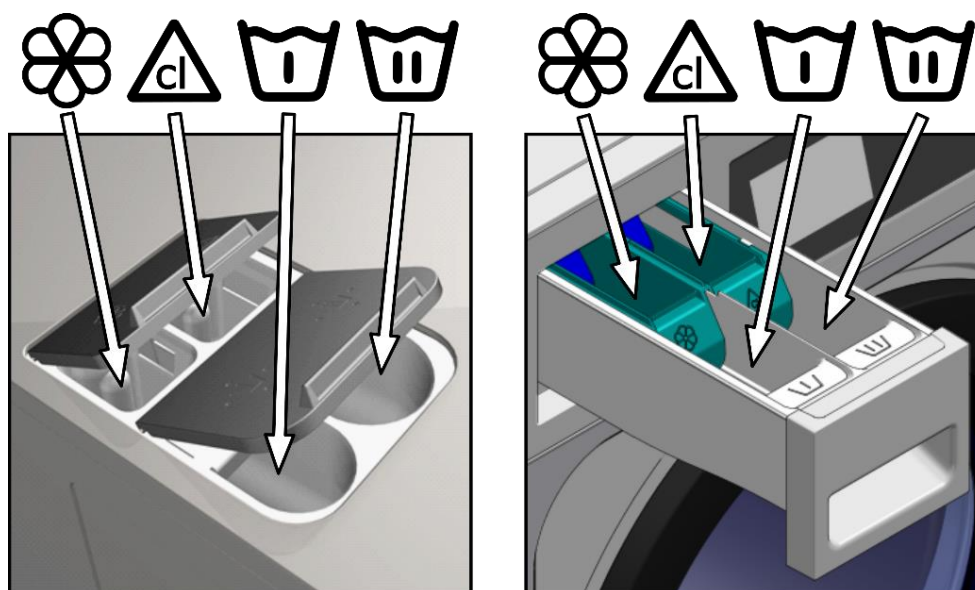
1.2 Uso do doseador

Adicione os produtos de lavagem a cada compartimento e feche a tampa do doseador.



-  Detergente em pó para pré-lavagem
-  Detergente em pó para lavagem
-  Amaciador líquido
-  Branqueador líquido (lixívia)

1.3 Características da máquina

O controlo da máquina é realizado por intermédio de um microprocessador programável com capacidade de se adaptar às necessidades de cada utilizador.

Dispõe de um controlo inteligente para a regulação da temperatura; caso disponha de água quente, ligue-a. A máquina de lavar faz a gestão das diferentes entradas de água para manter a temperatura programada.

Dispõe de controlo inteligente para a gestão da centrifugação. A máquina de lavar controla o desequilíbrio gerado pela carga e gere a rotação, a fim de garantir uma boa centrifugação, sem ruídos e prolongando a vida útil dos elementos de desgaste, assim como uma significativa redução da fadiga dos componentes mecânicos.

2 INTERFACE

Todas as máquinas de lavar possuem um ecrã tátil que, para além de se poder visualizar toda a informação, permite a seleção de todos os controlos apresentados no ecrã.

Quando a máquina for ligada, passa a *Ecrã Off*. O botão ON/OFF faz apresentar *Ecrã principal* e, a partir daqui, é possível iniciar um programa ou aceder ao menu principal. Premir START faz apresentar o *Ecrã execução*, mostrando no ecrã toda a informação relevante do mesmo.

Premir ON/OFF faz regressar o *Ecrã Off* a partir de qualquer ecrã onde se esteja.

A informação que aparece em cada um dos ecrã pode ser omitida ou apresentada no menu HUD (Ver secção 4.2.1)

2.1 Ecrã OFF OPL

Este ecrã é apresentado quando a máquina de lavar estiver desligada, mostrando os parâmetros configurados pelo utilizador.

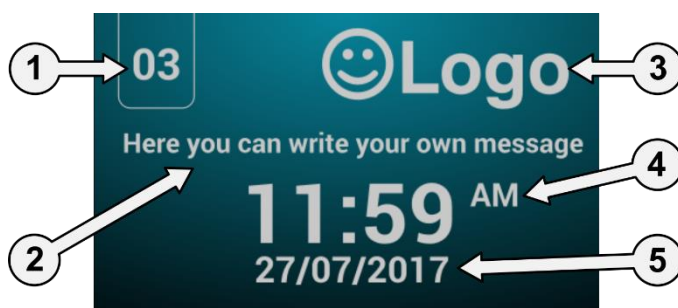

1. **Identificador da máquina:** Etiqueta que identifica a máquina (se estiver ativado).
2. **Mensagem lavandaria:** Mensagem configurada pelo utilizador (se estiver ativada).
3. **Logótipo:** É apresentado o logótipo (se estiver ativado).
4. **Hora:** Horas e minutos no formato selecionado.
5. **Data:** Data no formato selecionado (se estiver ativado no HUD).

Se a opção "poupança energética" estiver ativa, quando a máquina de lavar estiver desligada há 10 minutos apaga-se a retroiluminação do ecrã.

2.2 Ecrã principal OPL

O *Ecrã principal* da máquina de lavar é o seguinte e é aqui que se define cada uma das possíveis opções. Algumas das opções podem ser omitidas no menu HUD.



1. **Identificador da máquina:** Etiqueta que identifica a máquina.
2. **Hora:** Horas e minutos no formato selecionado.
3. **Peso da roupa:** É apresentado o peso da roupa introduzida (se o kit de pesagem estiver ativo) ou a carga nominal do modelo selecionado (se o kit não estiver ativo), podendo editar o peso da carga introduzida. Possibilidade de ativar/desativar no HUD. Quando o programa tiver terminado ou abortado, voltará a selecionar a carga nominal da máquina.
4.  **Menu principal:** Acesso ao menu principal da máquina de lavar, onde se poderá gerir os diferentes parâmetros da máquina.
5. **Nome do programa:** Nome configurado para o programa selecionado.
6. **Temperatura programa:** Temperatura máxima entre as diferentes fases que compõem o programa.
7. **Número e duração do programa:** Posição do programa na lista de programas (Os meus programas) e a duração, em minutos, estimada do programa selecionado.
8. **Aumento/diminuição do programa:** Permite avançar ou retroceder na lista de programas selecionados. Para além dos botões, poderá aumentar/diminuir o programa premindo diretamente na informação do programa (a que está por cima do botão).
9. **Start:** Botão para iniciar a execução do programa selecionado a partir da fase indicada.
10. **Fases do programa:** Premindo o ícone do programa selecionado, são apresentadas as fases que compõem o programa, podendo selecionar a fase pela qual pretende começar. Ainda assim, é possível realizar uma programação instantânea, ou seja, alterar os parâmetros que compõem uma fase (tempo, temperatura, nível e doseamento) para a execução em curso, valores que não serão guardados para futuras execuções.

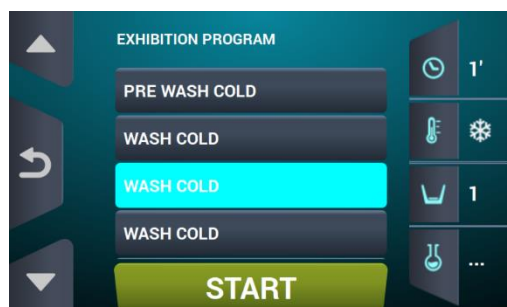





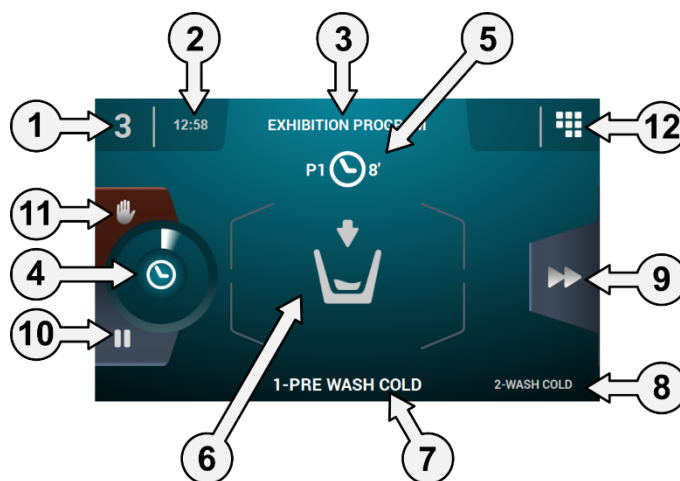

2.3 Ecrã execução OPL

Ao premir o botão START, inicia o programa e o ecrã apresenta toda a informação relevante do mesmo. Algumas das opções podem ser omitidas no menu HUD.





1. **Identificador da máquina:** Etiqueta que identifica a máquina.
2. **Hora:** Horas e minutos no formato selecionado.
3. **Programa em execução:** Nome do programa, Número do programa, Duração do programa.
4. **Indicador de progresso do programa:** Estado do progresso do programa, relação entre o tempo total e o tempo restante do programa.

- Número e duração do programa:** Posição do programa na lista de programas (Os meus programas) e a duração, em minutos, estimada do programa selecionado.
- Estado (desenho):** Desenho animado que mostra o que a máquina de lavar está a fazer (enchimento, esvaziamento, lavagem, enxaguamento, centrifugação ou descompactação).

	A abrir a porta.		Basculação frontal.
	A aquecer		Basculação posterior.
	Descompactação.		A centrifugar.
	A arrefecer.		A finalizar.
	A encher.		A lavar.
	A parar.		Paragem programada.
	A tirar a roupa.		A esvaziar.

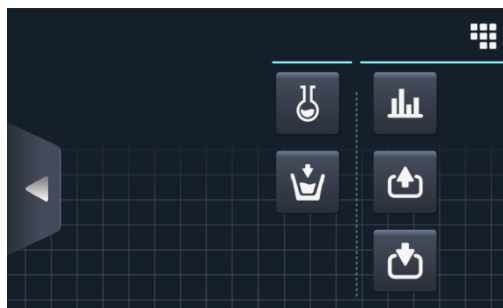
- Fase em execução:** Identificador e nome da fase em execução.
- Fase seguinte:** Identificador, nome e desenho da fase que vem a seguir (No caso de ser a última fase, não será mostrado nada).
- Avançar fase:** Botão que permite avançar para a fase seguinte (No caso de ser a última fase, não será mostrado nada). Para além do botão, poderá avançar a fase premindo diretamente na informação da fase seguinte (a que está por cima do botão).
- Pausa:** Botão que permite parar o programa em execução. Se o programa for colocado em pausa, o ícone passa do de reprodução ao de pausa, sendo possível recomeçar o programa onde foi interrompido.
- Stop:** Botão para abortar o programa. Surge uma mensagem de confirmação.
-  **Menu execução:** Acesso aos parâmetros em curso.



-  **Entradas:** É apresentado o estado de todas as entradas. As entradas que estiverem disponíveis em TODAS as máquinas são SEMPRE apresentadas. As entradas exclusivas de algum programa específico (por exemplo, Self-service, Sanitário, Doseadores extra, Tanques (T1, T2, T3), Basculação...) apenas estarão disponíveis se esse programa estiver ativado.

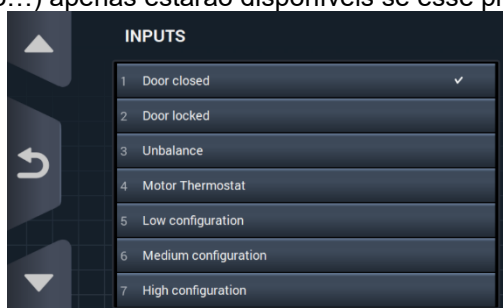

- 
Saídas: É apresentado o estado de todas as saídas. As saídas que estiverem disponíveis em TODAS as máquinas são SEMPRE apresentadas. As saídas exclusivas de algum programa específico (por exemplo, Self-service, Sanitário, Doseadores extra, Tanques (T1, T2, T3), Basculação...) apenas estarão disponíveis se esse programa estiver ativado.

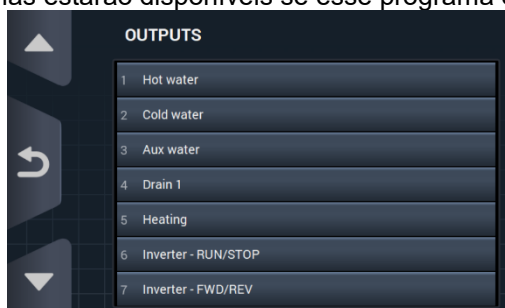

- 
Referências/valores: Apresentação de referências e valores reais da fase em execução (Temperatura, Nível, Tempo restante). Premindo os botões da coluna direita, é possível editar os valores de referência, tendo efeito apenas na execução em curso.

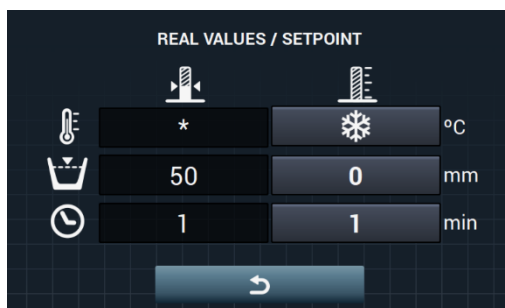

- 
Doseamento manual: Poderá aceder a esta secção, visualizar o estado de cada doseador (ON /OFF) podendo ativar/desativar o doseamento pretendido. As opções disponíveis estarão na base da configuração de kits existente. Ao sair do ecrã de doseamento, todos os doseadores serão desativados.



- 
Entrada de água manual: Poderá aceder a esta secção, visualizar o estado de cada entrada de água (ON /OFF) podendo ativar a pretendida. A entrada de água que estiver ativada pelo algoritmo de enchimento não poderá ser desativada. Ao sair do ecrã de entrada de água, todas as entradas de água ativadas serão desativadas manualmente.

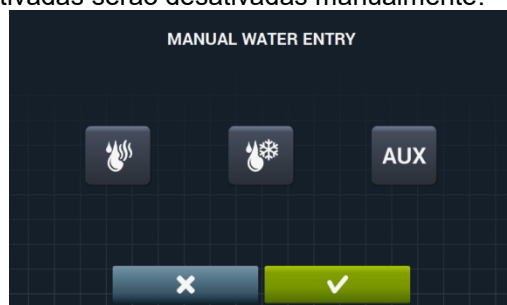

3 PROGRAMAS

Apresenta uma biblioteca de programas composta por todos os programas predefinidos, assim como pelos programas criados pelo próprio utilizador.





Antes de passar à explicação da gestão dos programas (ver secção 4.1), vamos expor quais são os seus parâmetros e quais são os programas padrão existentes na biblioteca.





3.1 Parâmetros de fase

Cada programa é formado por uma série de fases, as quais são compostas por um conjunto de parâmetros configuráveis, dependendo do tipo de fase em questão.

3.1.1 Parâmetros para fases de molho, pré-lavagem, lavagem ou enxaguamento:



- Nome da fase:** Nome que identifica a fase. Não será o texto apresentado no *Ecrã de execução*, mas o que identifica uma fase criada.
- 
Tempo: Valor, em minutos, da duração da fase. Intervalo configurável de 1 a 99.
- 
Temperatura: Temperatura, °C ou °F, de execução da fase. Intervalo configurável de 20°C (68°F) a 90°C (194°F).
- 
Nível: Nível de água ao qual se deverá executar a fase. Intervalos configuráveis (ver secção 4.2). Existem 5 tipos de níveis: Mínimo (1), Baixo (2), Médio (3), Alto (4), Máximo (5).
- 
Velocidade: Velocidade de execução da fase. Intervalos configuráveis (ver secção 4.2). Podem ser escolhidos 4 tipos de velocidades diferentes: Mínimo (1), Baixo (2), Normal (3), Alto (4).
- 
Ritmo de lavagem: Sequência de movimento que a máquina de lavar tem de seguir (tempo de funcionamento (seg.) / tempo de paragem (seg.)). Intervalo configurável de 1 a 99. O tambor rodará alternadamente para a esquerda e para a direita.

- 
Entrada de água: Indica a seleção da entrada de água desejada.
 - Água quente: Carregar água a partir da entrada de água quente (Sim/Não)
 - Água fria: Carregar água a partir da entrada de água fria (Sim/Não)
 - Auxiliar: Carregar água a partir da entrada de água auxiliar (Sim/Não)
 - Regulação de água: Carregar água a partir uma ou outra entrada dependendo da temperatura (Sim/Não).
 - T1, T2, T3: Carregar água de algum dos tanques, se tiver o KIT recuperador.
- 
Esvaziamento: Mostra se se deve esvaziar a água quando a fase termina, assinalando por qual das saídas esvaziar no caso de ter o kit de recuperador de água ativo.
- 
Arrefecimento: Opção que permite arrefecer a temperatura numa fase antes de esvaziar ou passar à fase seguinte. Parâmetro apenas configurável se a temperatura da fase for igual ou superior a 40°C (104°F). Intervalo configurável, de 30°C (86°F) à referência da fase. Para além de poder seleccionar o valor de arrefecimento, há um botão que permite ativar ou desativar esta opção.
- 
Doseamento 1..8: Cada doseamento poderá ser ativado de forma independente, sendo preciso configurar os seguintes parâmetros no caso de ser ativado:
 - Início: Se o doseamento X estiver ativo, é preciso indicar quando deve começar o referido doseamento.





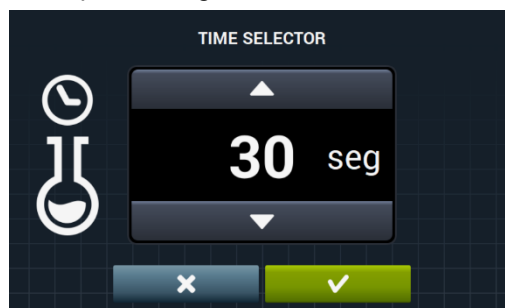

- Nível de segurança (ML): Começa o doseamento quando atingir o nível de segurança.
 - Nível (L): Começa o doseamento quando atingir o nível definido.
 - Temperatura (T): Começa o doseamento quando atingir a temperatura definida.
- Tempo: Tempo, em segundos, do doseamento X. Intervalo configurável de 0 a 99.

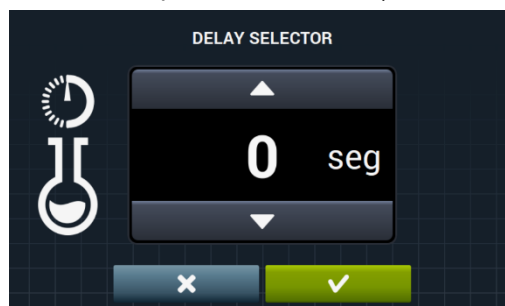







- Atraso: Atraso, em segundos, do doseamento X. Quando chegar ao ponto de início indicado, o doseamento é atrasado pelo tempo indicado. Intervalo configurável de 0 a (tempo de fase-tempo de doseamento).

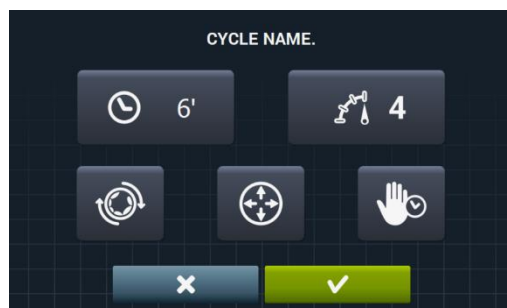

-  **Funcionamento cheio:** Rotação do tambor enquanto enche (Sim/Não).
-  **Movimento em esvaziamento:** Rotação do tambor enquanto esvazia (Sim/Não).
-  **Paragem térmica:** Assinalar o tempo a partir do qual começa a contar o tempo estipulado para a fase (Sim/Não).
-  **Paragem de programa:** Permite realizar uma paragem no programa antes que comece a execução da fase em questão. A paragem será indicada no ecrã e o aviso será feito por intermédio de um sinal acústico. (Sim/Não).
Se este parâmetro estiver ativo, antes de começar a fase, a máquina de lavar passa ao estado de pausa, indicando no ecrã a mensagem "Pausa programada". Para prosseguir a execução do programa, deve premir o botão PLAY.

3.1.2 Parâmetros para fases de centrifugação:











-  **Tempo:** Valor, em minutos, da duração da centrifugação. Intervalo configurável de 1 a 99.
-  **Velocidade:** Velocidade de centrifugação. Podem ser escolhidos 4 tipos de velocidades diferentes: Mínimo (1), Normal (2), Médio (3), Máximo (4). Os valores Médio (3) e Máximo (4) só estão disponíveis no caso das máquinas de lavar de altas e médias rotações, respetivamente. Intervalo configurável.
-  **Descompactação:** Descompactar ao finalizar a fase de centrifugação (Sim/Não).
-  **Distribuição ótima:** Se esta opção estiver ativa, não vai descarregar na fase anterior.
-  **Paragem de programa:** Permite realizar uma paragem no programa antes que comece a execução da fase em questão. A paragem será indicada no ecrã e o aviso será feito por intermédio de um sinal acústico. (Sim/Não).

3.2 Biblioteca de fases













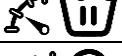

Estas são as fases que, por predefinição, existem na biblioteca de fases e que servirão para compor novos programas.

- De molho
 - **F1:** De molho
- Pré-lavagens
 - **F2:** Pré-lavagem Normal Fria
 - **F3:** Pré-lavagem Normal 40°C (104°F)
 - **F4:** Pré-lavagem Delicada Fria
 - **F5:** Pré-lavagem Delicada 40°C (104°F)
 - **F6:** Pré-lavagem Muito Delicada Fria
 - **F7:** Pré-lavagem Muito Delicada 40°C (104°F)
 - **F8:** Pré-lavagem Wet
- Lavagens
 - **F9:** Lavagem Normal Fria
 - **F10:** Lavagem Normal 60°C (140°F)
 - **F11:** Lavagem Normal (194°F)
 - **F12:** Lavagem Delicada Fria
 - **F13:** Lavagem Delicada 40°C (104°F)
 - **F14:** Lavagem Muito Delicada Fria
 - **F15:** Lavagem Muito Delicada 40°C (104°F)
 - **F16:** Lavagem Wet Fria
 - **F17:** Lavagem Wet 40°C (104°F)
- Enxaguamento
 - **F18:** Enxaguamento Normal
 - **F19:** Enxaguamento Normal Final
 - **F20:** Enxaguamento Delicado
 - **F21:** Enxaguamento Delicado Final
 - **F22:** Enxaguamento Muito Delicado
 - **F23:** Enxaguamento Muito Delicado Final
 - **F24:** Enxaguamento Wet
 - **F25:** Enxaguamento Wet Final
- Centrifugações
 - **F26:** Centrifugação Longa
 - **F27:** Centrifugação Curta







































Símbolos das fases:

	De molho	
	Pré-lavagens	 : Pré-lavagem fria,  40: Pré-lavagem 40°C (104°F), ...
	Lavagens	
	Enxaguamento	 : Enxaguamento,  : Enxaguamento final com amaciador
	Centrifugações	

Símbolos y valores de los parámetros:

	Tempo	Valor em minutos
	Temperatura	Valor em °C (°F)
	Nível	1:Mínimo,2:Baixo, 3: Médio, 4:Alto, 5:Máximo
	Velocidade de lavagem	1:Mínimo,2:Baixo, 3:Normal, 4:Alto,
	Velocidade de centrifugação	2:Normal, 3: Médio 4:Máximo
	Entrada de água	0:Fria, 1:Fria/Quente conforme a regulação
	Ritmo de lavagem	Tempo de funcionamento (seg.) ; Tempo de paragem (seg.)
	Funcionamento cheio	✓ : Sim
	Paragem térmica	✓ : Sim
	Movimento em esvaziamento	✓ : Sim
	Esvaziamento	✓ : Sim
	Arrefecimento	✓ : Sim
	Distribuição ótima	✓ : Sim
	Paragem de programa	✓ : Sim
	Descompactação	✓ : Sim
D	Doseamento	Entrada por onde doseia (D1:Doseamento 1, ...) com o seu INÍCIO/TEMPO/ATRASSO configurado em ML/0/30

Tabelas de fases com os seus parâmetros:

	F1		F2		F3		F4		F5		F6		F7		F8
			 	 40	 	 40	 	 40	 						
	3		5	5	6	6	6	6	6	6	6	6	6	5	
	3			40		40		40		40		40			
	3		1	1	3	3	3	3	3	3	3	3	3	3	
	0		3	3	2	2	2	2	2	2	2	2	2	1	
	15;05		0	1	0	1	0	1	0	1	0	1	0	0	
	✓		15;05	15;05	10;08	08;06	5;15	5;15	02;02						
	✓		✓	✓										✓	
	✓			✓		✓		✓		✓		✓			
			✓	✓										✓	
			✓	✓	✓	✓	✓	✓	✓	✓	✓	✓	✓	✓	✓
D		D	D1	D1	D1	D1	D1	D1	D1	D1	D1	D1	D1	D1	D1

	F9	F10	F11	F12	F13	F14	F15	F16	F17
	10	10	10	12	12	12	12	10	10
		60	90		40		40		40
	1	1	1	1	1	1	1	2	2
	3	3	3	2	2	2	2	1	1
	0	1	1	0	1	0	1	0	1
	15;05	15;05	15;05	10;08	10;08	05;15	05;15	02;02	02;02
	✓	✓	✓					✓	✓
		✓	✓		✓		✓		✓
	✓	✓	✓					✓	✓
	✓	✓	✓	✓	✓	✓	✓	✓	✓
D	D2, D3	D2, D3	D2, D3	D2	D2	D2	D2	D2	D2

	F18	F19	F20	F21	F22	F23	F24	F25
	2	2	3	3	3	3	2	2
	4	4	4	4	4	4	4	4
	3	3	2	2	2	2	1	1
	15;05	15;05	10;08	10;08	05;15	05;15	02;02	02;02
	✓	✓					✓	✓
	✓	✓					✓	✓
	✓	✓	✓	✓	✓	✓	✓	✓
D		D4		D4		D4		D4

	F26	F27
	2	6
	2	4
	✓	✓
	✓	✓

3.3 Biblioteca de programas

Estes são os programas que existem predefinidos na biblioteca de programas:

P1: Energético 90°C (194°F)	P10: Extra delicado frio
P2: Energético 60°C (140°F)	P11: Económico 90°C (194°F)
P3: Energético 30°C (86°F)	P12: Económico 60°C (140°F)
P4: Energético frio	P13: Económico 30°C (86°F)
P5: Normal 60°C (140°F)	P14: Económico frio
P6: Normal 30°C (86°F)	P15: Sluice
P7: Normal frio	P16: Centrifugação longa
P8: Delicado 40°C (104°F)	P17: Centrifugação curta
P9: Delicado frio	



A tabela de todos os programas com os respetivos parâmetros encontra-se nas últimas páginas deste manual.

4 CONFIGURAÇÃO

Segue-se o menu principal de configuração da máquina de lavar, onde se podem configurar diferentes parâmetros da máquina, assim como visualizar ou descarregar dados que estejam armazenados.

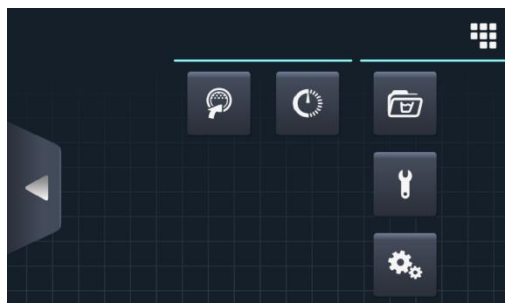
Acede-se a este menu a partir do ícone  do **Ecrã principal** (ver secção 2.2)





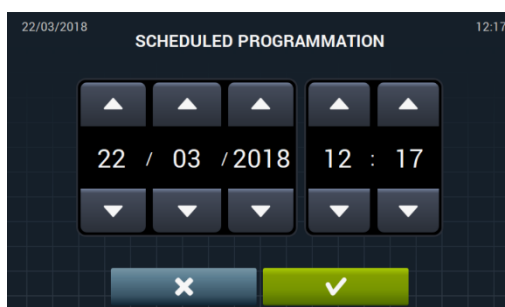

-  **Easy load:** Opção que ajuda a carregar a roupa.
-  **Programação atrasada:** Permite atrasar uma lavagem para que se execute a uma data/hora pretendida. Quando premir o botão de "programação atrasada", será solicitada a introdução da data/hora pretendida.

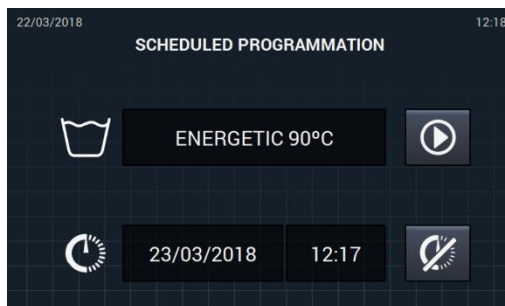

passando a um ecrã onde se indica a data/hora do programa, juntamente com o número e nome do programa.



-  Executar o programa antes da hora prevista.
-  Cancelar a programação realizada.
-  **Gestão de programas:** Gestão de todos os programas armazenados, assim como dos programas ativos nesse momento. (Ver secção 4.1)
-  **Configurar sistema:** Configuração de diferentes secções da máquina de lavar. (Ver secção 4.2)
-  **Manutenção:** Diversas opções para o técnico protegidas por palavra-passe.



4.1 Gestão de programas

A partir deste submenu podem ser geridos todos os programas, tanto os que foram selecionados pelo utilizador, como os que se encontram na biblioteca. Para tal, terá de seleccionar entre "Biblioteca de fases", "Os meus programas" e "Biblioteca de programas".

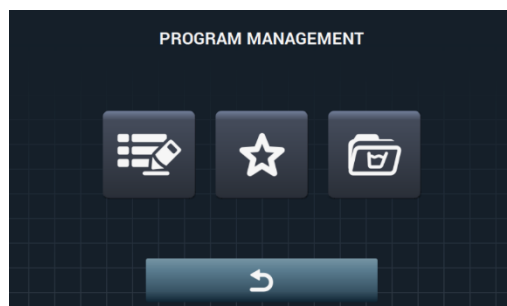
Acesso: [Ecrã principal]  ⇒ [Menu Principal] 





Existirá uma biblioteca onde serão armazenados todos os programas e fases, programas incluídos por predefinição e programas criados/importados pelo utilizador.

-  **Os meus programas:** Disponíveis no Ecrã principal OPL. (Ver secção 4.1.1).
-  **Biblioteca de programas:** (Ver secção 4.1.2).
-  **Biblioteca de fases:** (Ver secção 4.1.3).

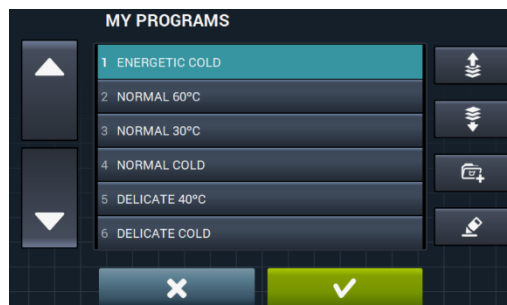

4.1.1 Os meus programas (favoritos).

Os programas da pasta "Os meus programas" são aqueles que vão estar disponíveis no Ecrã principal OPL.

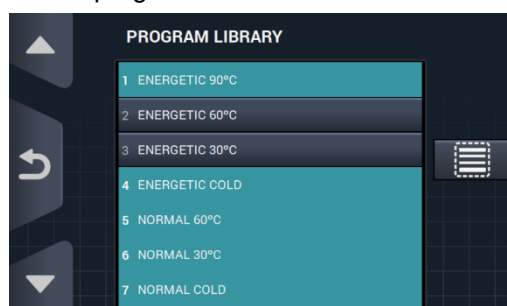

-  **Adicionar/eliminar programas:** Premindo iremos à biblioteca de programas. Nesta, estarão destacados os programas que estejam incluídos atualmente em "Os meus programas", podendo ser selecionados/desselecionados um a um os programas que queremos adicionar/eliminar dos favoritos.
 -  **Selecionar/desselecionar tudo:** Seleciona ou desseleciona toda a lista da biblioteca de programas.



-  **“seta para cima”** e  **“seta para baixo”:** Poderemos alterar a posição de qualquer programa dos favoritos, podendo colocar os programas dos favoritos pela ordem que quisermos.

- 
Botão Editar: Premindo este botão, poderemos editar o programa selecionado como se estivéssemos a editá-lo a partir da biblioteca de programas.



Premindo OK ou Cancelar, regressamos a Os meus programas.

4.1.2 Biblioteca de programas

É possível adicionar, copiar, modificar ou eliminar programas, para além de se poder importar novos programas ou exportá-los para uma memória USB externa.

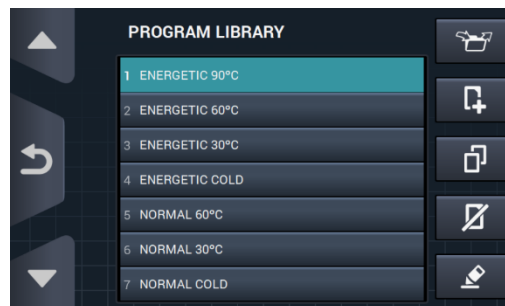

- 
Criar programa: Criação de novos programas de lavagem a partir das fases existentes na biblioteca. Premindo este botão, será primeiro solicitada a introdução do nome do novo programa.

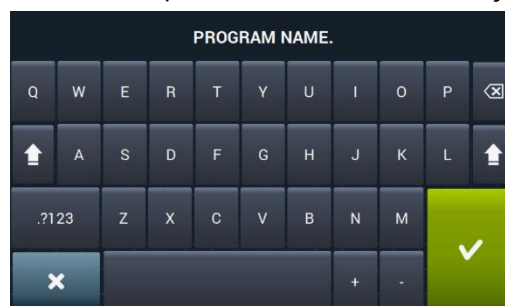

Em seguida, será apresentado o seguinte ecrã (sem nenhuma fase) para poder incluir fases a partir da biblioteca de fases.

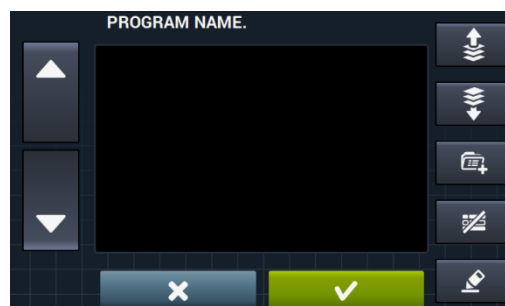





- 
 É possível adicionar fases a partir da biblioteca de fases, podendo filtrar as fases que se pretenda visualizar com base no tipo de fase.





Uma vez selecionada a fase, podem ser consultados os parâmetros das fases da biblioteca antes de inclui-los no programa que se está a criar.





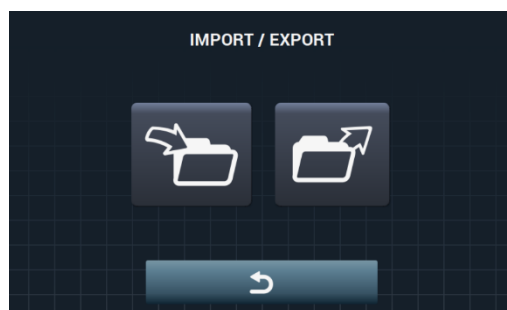

Cada programa será um conjunto de parâmetros agrupados por fases que não terão qualquer relação com as fases existentes na biblioteca.

- 
Copiar programa: Cópia de um programa existente na biblioteca, atribuindo-lhe um novo nome.
- 
Modificar programa: Modificação tanto do nome como das fases que o compõem, podendo adicionar, modificar, eliminar ou alterar a ordem das fases existentes. Tal como acontece na criação de um novo programa, ao modificá-lo será possível adicionar/eliminar fases a partir da biblioteca de fases. No momento de criar os programas, só se podem consultar os parâmetros das fases; poderá haver modificações quando se permitir modificar as fases já existentes no programa.
- 
Eliminar programa: Eliminação dos programas armazenados na biblioteca.
- 
Importar/Exportar Configuração: Permite importar/exportar programas a partir de uma memória USB externa.



- 
Importar programa: Permite importar novos programas a partir de uma memória USB externa. Ao aceder à memória USB, são apresentados apenas os ficheiros com extensão “. prg” para além das pastas.

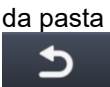

-  **Marcador:** Indica o número de programas seleccionados.
-  **Selecionar/desselecionar tudo:** Selecciona ou desselecciona todos os programas da pasta em que estiver.
-  **Retroceder:** Permite sair da pasta em que estiver.
No caso de importar um programa com o mesmo nome do já existente, será solicitado se pretende substituir o programa em questão ou cancelar a operação. Como podem estar muitos programas na mesma situação, haverá uma caixa para "fazer o mesmo em todos os casos".
-  **Exportar programa:** Exportar programas existentes na biblioteca para uma memória USB externa.



É possível seleccionar os programas a serem exportados.

-  **Selecionar/desselecionar favoritos:** Permite seleccionar todos os programas ou apenas os programas que estão dentro dos favoritos, estando sempre indicada a quantidade de programas seleccionados.

O conjunto de programas seleccionados será guardado numa pasta "PROGRAMS" na raiz do directório da memória USB e cada programa será um ficheiro.

4.1.3 Biblioteca de fases

A partir da biblioteca de fases, poderá modificar o nome de cada fase. Depois de incluído num programa, no momento de visualizar a informação das fases, o nome apresentado para a fase será outro. Será um nome dinâmico composto pelo tipo de fase e por um parâmetro (Tº, rpm).

A biblioteca de fases será editável, sendo possível criar, modificar, copiar ou eliminar as fases existentes (Ver secção 3.1).



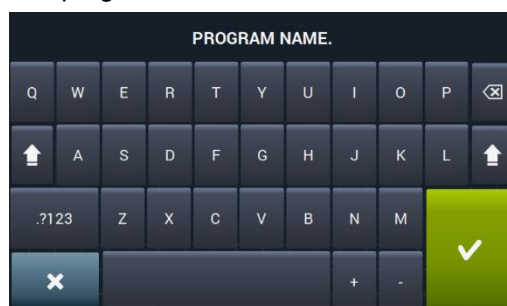

-  **Criar fase:** Criação de novas fases de lavagem. Premindo este botão, será primeiro solicitada a introdução do nome do novo programa.

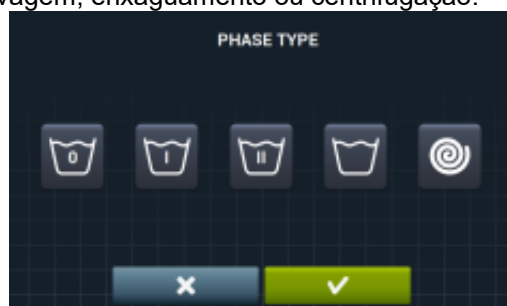

Em seguida, será mostrado o ecrã seguinte para poder seleccionar o tipo de fase que pretende criar: de molho, pré-lavagem, lavagem, enxaguamento ou centrifugação.







-  **Copiar fase:** Cópia de uma fase existente na biblioteca, atribuindo-lhe um novo nome.
-  **Eliminar fase:** Eliminação das fases armazenadas na biblioteca.
-  **Modificar fase:** Modificação dos parâmetros da fase seleccionada.

4.2 Configurar Sistema

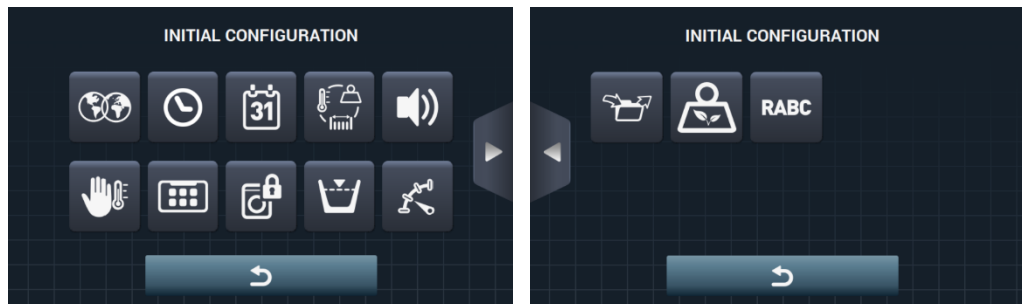
Acesso: [Ecrã principal]  ⇒ [Menu Principal] 

Na configuração do sistema, será possível configurar as seguintes secções:



-  **Ecrã seguinte.**
-  **Ecrã anterior.**
-  **Idioma:** Os textos da máquina de lavar podem ser visualizados em 34 idiomas diferentes; a edição dos textos só pode ser efetuada com caracteres ocidentais.



-  **Hora:** Configuração da hora do momento. É possível seleccionar o formato de visualização (12 horas/24 horas (predefinição)).

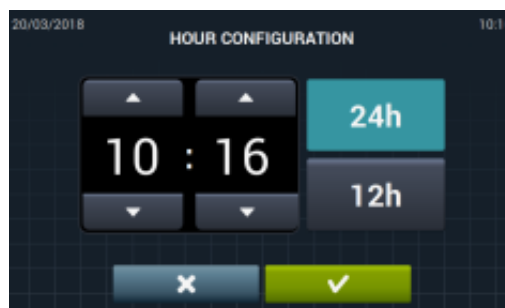

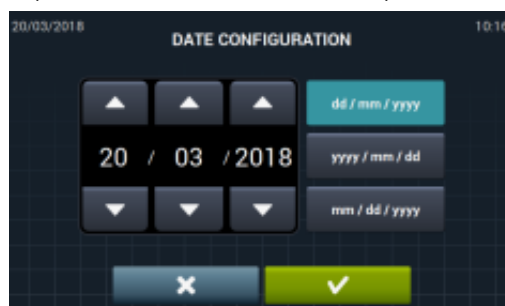

-  **Data:** Configuração da data do momento. É possível seleccionar o formato de visualização (dd/mm/aaaa (predefinição) / aaaa/mm/dd / mm/dd/aaaa).







- 
Unidades de medida: Permite seleccionar a unidade de medida em que se pretende visualizar a temperatura (°C (predefinição) ou °F), o peso (Kg (predefinição) ou Lb) e o tamanho (mm (predefinição) ou in).







- 
Paragem térmica: Configuração geral da paragem térmica. Se estiver desativada, a paragem térmica não será realizada, mesmo que a fase em execução tenha ativo o referido parâmetro. Se, pelo contrário, estiver ativada, será respeitada a configuração de cada fase, agindo-se em conformidade. Predefinição: ativada. Nas máquinas sem aquecimento (HW), estará sempre desativado.
- 
Poupança de água na pesagem: É possível configurar a poupança de água pretendida para a pesagem, podendo optar entre 3 opções diferentes de pesagem e 3 níveis de poupança. Dependendo da carga, haverá uma redução ou outra no nível de água e doseamento de detergente.

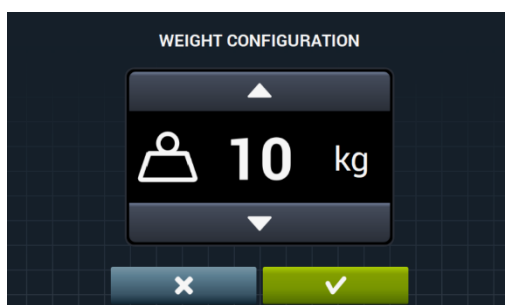

- 
 Opção de pesagem desativada.
- 
 Opção de pesagem automática, estará disponível com base na configuração de kits existentes.
- 
 Opção de pesagem manual, o peso da roupa será introduzido de forma manual, premindo o ícone do peso no ecrã principal (Ver secção 2.2, ponto 3).
- 
 Opção de pesagem inteligente, esta opção faz uma estimativa da carga no início de qualquer programa. A mensagem "LOAD DETECTION" aparecerá enquanto estiver em execução. Esta opção pode durar vários minutos. O tempo empregue não está incluído na duração do programa.





- 
 Opção de poupança desativada.
- 
 Opção de poupança baixa.

-  Opção de poupança média.
-  Opção de poupança alta.
-  **Níveis:** Permite a configuração em mm dos 5 níveis configuráveis. Cada tipo de nível terá um valor predefinido e um intervalo de configuração, valores que dependerão do modelo seleccionado. (Ver tabela de níveis por modelo).

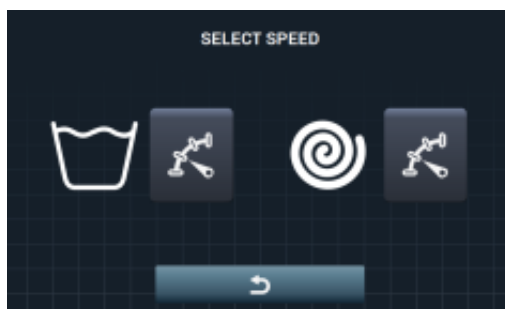

-  **Velocidade:** Permite a configuração das RPM dos diferentes tipos de velocidades existentes, tanto na lavagem como na centrifugação. Cada tipo de velocidade terá um valor mínimo e máximo de configuração. (Ver tabela de equivalências RPM/V por modelo).



- 
Importar/Exportar Configuração: Permite importar uma configuração de máquina a partir de uma memória USB ou exportar para uma memória USB a configuração atual da máquina. Ao premir este botão, será apresentado um ecrã intermédio para selecionar se queremos importar ou exportar (tal como nos programas).

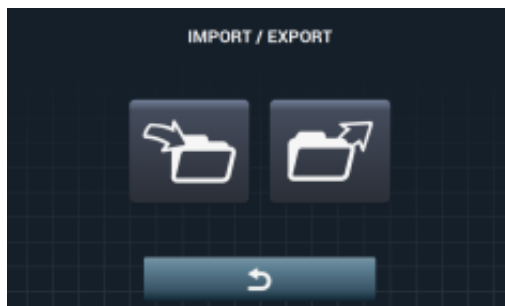

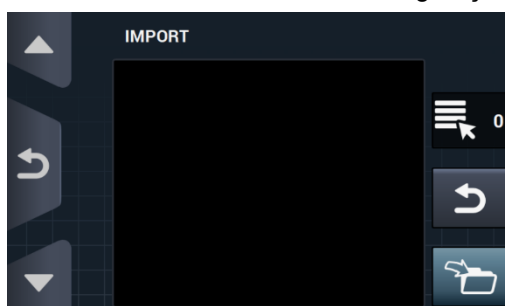

Se selecionarmos IMPORTAR, será apresentado o ecrã para podermos navegar pela memória USB, mas apenas poderão ser selecionados os ficheiros de configuração (extensão .cfg).



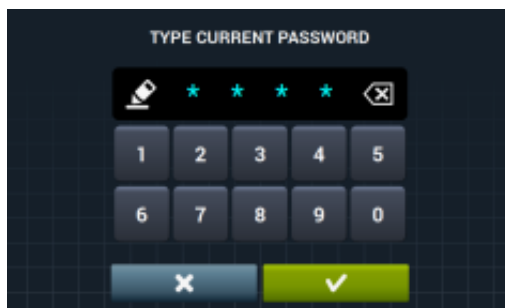

Se selecionarmos EXPORTAR, manterá a configuração atual da máquina no diretório raiz da memória USB na pasta "CONFIGS". Cada ficheiro de configuração terá a seguinte forma de denominação: CONFIG_Modelo_Fecha_hora.cfg.

- 
Acesso restringido: Permite restringir a configuração da máquina de lavar, definindo uma palavra-passe para entrar no menu principal. Predefinição: desativada. É possível configurar a palavra-passe pretendida (1234 na predefinição) para entrar no menu principal.



- 
HUD: A configuração HUD ativa/desativa a visualização dos parâmetros nos diferentes ecrãs (ver secção 4.2.1).



-  **Beep:** Opção que permite desativar o sinal sonoro. Predefinição: ativada.
-  **RABC/Rastreabilidade:** Será registada a informação de cada lavagem, guardando a informação seguinte:
 No começo de cada ciclo: Programa, hora de início, peso (se houver)
 Durante a execução, a cada 15 segundos: Nível, temperatura e error (se houver)
 Quando os dados forem descarregados, será preciso selecionar o período pretendido (predefinição: data de início e data de fim, o dia atual).
 Os dados serão guardados durante, pelo menos, 15 dias.
 Cada vez que houver uma descarga, será criada uma “RABC” no diretório raiz da memória USB. Cada ficheiro rabc terá a seguinte forma de denominação: RABC_Modelo_Fecha_hora.rabc.

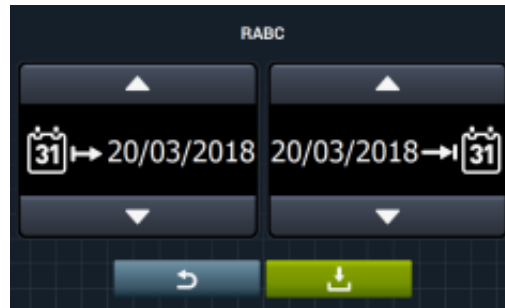

4.2.1 Configuração HUD

Configuração dos parâmetros que se pretende visualizar no *ecrã OFF*, *ecrã principal* e *ecrã de execução*, para além da execução da configuração do apagamento automático e da poupança de energia.

Acesso: [Ecrã principal]  ⇒ [Menu Principal]  ⇒ [Configurar sistema] 

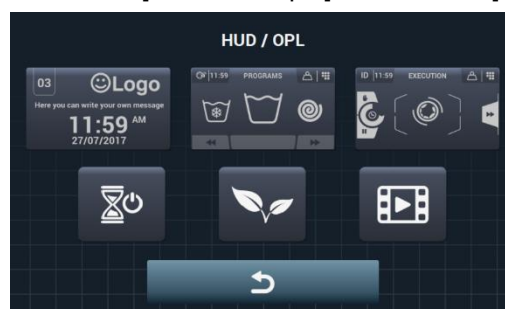

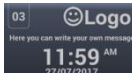

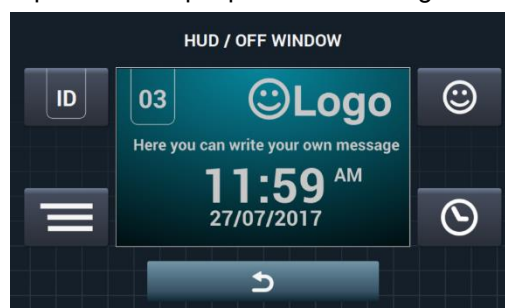
-  **Ecrã OFF:** Os parâmetros que podem ser configurados são os seguintes:



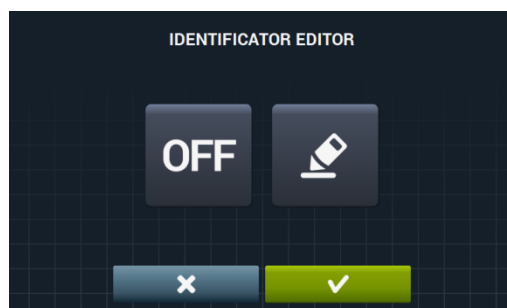

-  **Identificador da máquina:** É possível ativar/desativar a identificação da máquina, para além de se poder editar o número que se lhe quer atribuir (Entre 1 e 99). Predefinição: desativada. Este identificador será obrigatório em caso de usar comunicação remota.

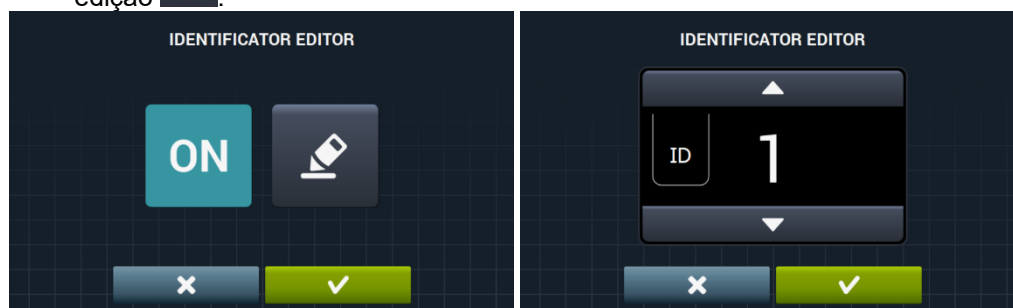

É possível ativar o identificador da máquina premindo o botão “OFF”  e depois o botão de edição .



-  **Data:** Opção que pode ser ativada/desativada. Predefinição: ativada.
-  **Logótipo:** Permite seleccionar se se pretende apresentar o logótipo. Predefinição: ativada.

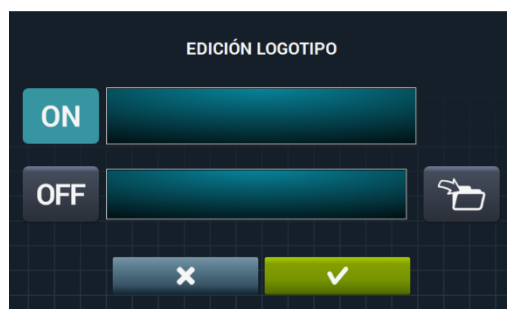

Premindo o botão importar , é possível importar um logótipo para a máquina a partir de uma memória USB externa; o ficheiro do logótipo tem que ser em formato .png e ter uma resolução de 290 x 80 píxeis.

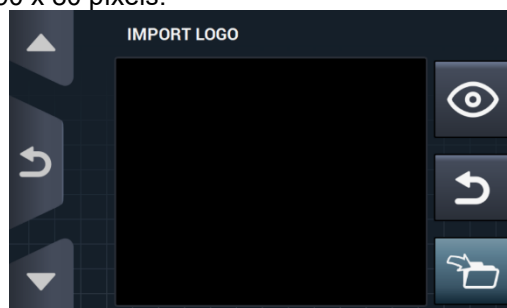





O botão de pré-visualização , permite verificar se o logótipo é visualizado corretamente.

-  **Mensagem lavandaria:** Mensagem inicial que poderá ser editada pelo utilizador (Máx. 40 caracteres). Predefinição: desativada.

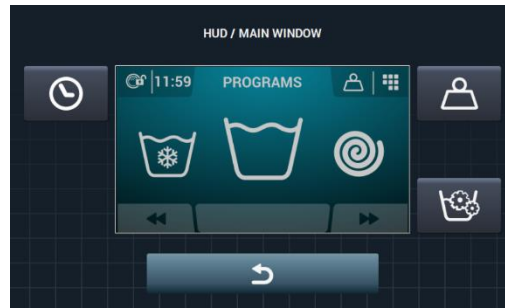

- **Ecrã principal:** Seguem-se os parâmetros que podem ser configurados:





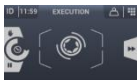



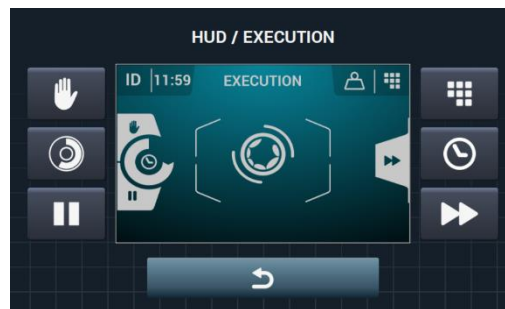

-  **Hora:** Opção que permite mostrar/ocultar a hora. Predefinição: ativada.
-  **Peso da roupa:** Caso esta opção seja desativada, não será mostrado o ícone do peso. Predefinição: desativada.
-  **Programação instantânea:** Se a programação instantânea estiver desativada, permitirá visualizar os parâmetros de cada fase, mas não podem ser editados. Predefinição: ativada.





- **Ecrã de execução:** Estas são as opções permitidas no ecrã de execução:



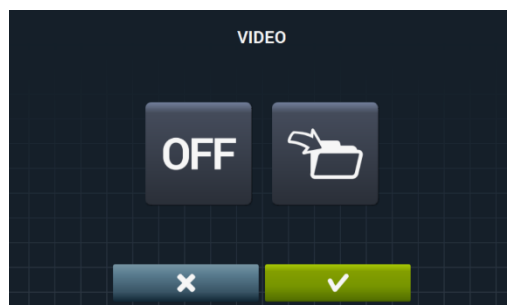

-  **Hora:** Opção que permite mostrar/ocultar a hora. Predefinição: ativada.
-  **Tempo restante:** Opção para mostrar/ocultar o tempo restante total e o indicador de progresso do programa no ecrã de execução. Predefinição: ativada.
-  **Botão de paragem, STOP:** Permite ocultar o botão de paragem. Predefinição: ativada.
-  **Botão PAUSE:** Permite ocultar o botão de pausa. Predefinição: ativada.
-  **Botão de menú:** Opção que permite mostrar/ocultar o ícone do menu de execução. Predefinição: ativada.
-  **Botão de Avanço:** Permite ocultar o botão de avanço e a informação que faz referência à fase seguinte. Predefinição: ativada.
-  **Apagamento automático:** Se esta opção estiver ativa e se estiver no ecrã principal, passa a *Ecrã Off* após 30 minutos sem qualquer atividade. Predefinição: ativada.
-  **Poupança de energia:** Opção que permite poupar energia desligando a retroiluminação do ecrã 10 minutos após ter desligado a máquina de lavar. Se tocar em qualquer parte do ecrã, a retroiluminação acende-se de novo e irá para o ecrã principal. Predefinição: ativada.

-  **Importar vídeo:** Permite reproduzir um vídeo no ecrã da máquina após 10 minutos de inatividade. Se “Poupança de energia” for ativada automaticamente, a reprodução do vídeo é desativada.

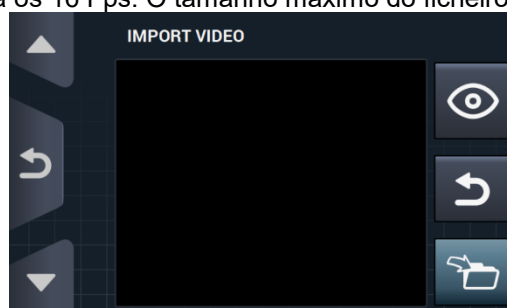

Preindo o botão importar , é possível importar um vídeo para a máquina a partir de uma memória USB externa; só poderão ser importados ficheiros de vídeo (avi, mov,...), e apenas poderá ser instalado um ficheiro de vídeo na máquina. A resolução recomendada dos vídeos será, para as máquinas com ecrã de 4,3" de 480x272 píxeis e para as máquinas com ecrã de 7" de 800x480 píxeis. Não é aconselhável que exceda os 16 Fps. O tamanho máximo do ficheiro não deve superar os 25 Mb.



O botão de pré-visualização , permite verificar se a reprodução do ficheiro de vídeo é correta.

5 MANUTENÇÃO

5.1 Irregularidades elétricas e mecânicas

Antes de contactar o Serviço de Assistência Técnica, verifique o seguinte:

- A máquina recebe eletricidade.
- O estado dos fusíveis.
- Que a tensão coincide com a da máquina.

Se a máquina de lavar não atingir o nível de água, verifique o seguinte:

- Que a válvula de passagem da água está aberta.
- Que o filtro de entrada de água não está obstruído.
- Que a pressão da água da rede está entre 2/4 Kg/cm² (28/56 psi).

Se a máquina de lavar vibrar de forma excessiva, verifique se nenhum dos parafusos dos painéis está desapertado.

Se houver um corte da tensão: Se a cuba se esvazia e se a porta fica bloqueada. Se quiser tirar a roupa da máquina de lavar, pode desbloquear a porta puxando para baixo a correia situada por trás do painel frontal.

5.2 Avisos

Todos os avisos e erros são apresentados no ecrã acompanhados por um aviso acústico. Em caso de erro, mantém-se a informação da fase e do estado, para saber exatamente onde ocorreu o erro.

Estes são os avisos que podem ser apresentados na máquina de lavar:

DESCRIÇÃO	CAUSA E AÇÃO
PORTA ABERTA	Se a porta estiver aberta no começo do programa, será apresentada no ecrã a mensagem "PORTA ABERTA" e o sinal sonoro apitará durante 30 segundos, não apitando mais posteriormente. Apenas terá a opção de "OK". O programa não começará e o utilizador pode voltar a tentá-lo.
ÁGUA NA CUBA	Quando um programa terminar, se tivermos um nível de água de 0 mm, será apresentada no ecrã a seguinte mensagem "ÁGUA NA CUBA". Serão apresentadas as 2 opções "continuar" ou "finalizar". Se premir "continuar", voltará a verificar se o nível é 0 mm. Se assim for, a porta é desbloqueada, caso não volte a dar erro. Se premir "finalizar", terminará o programa e desbloqueará a porta.
NÃO HÁ COMUNICAÇÃO ENTRE CARTÕES	Dentro do menu SAT, na secção de Kits extra, ao ir ativar um kit, se não for detetada comunicação entre o cartão de controlo principal e o cartão auxiliar, será dado este aviso. É possível desativar kits ativos sem comunicação entre cartões, mas não será possível ativá-los.
TANQUES CHEIOS (T1/T2/T3)	Dará este aviso quando o tanque Tx estiver ativo numa fase de esvaziamento e for detetado que a entrada "Nível máx. Tanque x" foi ativada. Não continuará a esvaziar e passará para o esvaziamento normal D1. Sinal sonoro ativo durante 10 segundos. O aviso desaparecerá ao premir OK ou ao passar o tempo.
TANQUES VAZIOS (T1/T2/T3)	Dará este aviso quando o tanque Tx estiver ativo numa fase de esvaziamento e for detetado que a entrada "Nível mín. Tanque x" foi ativada. Não continuará a encher a partir do Tx e passará a encher com água fria normal. Sinal sonoro ativo durante 10 segundos. O aviso desaparecerá ao premir OK ou ao passar o tempo.

NÃO HÁ COMUNICAÇÃO COM O KIT DE PESAGEM	Dará este aviso se, ao ir ativar o kit de pesagem ou realizar uma calibração, o cartão auxiliar estiver ligado e a funcionar corretamente, mas não puder comunicar com o aparelho de pesagem. Não será possível ativar o kit nem realizar a calibração.
CALIBRAÇÃO DE PESAGEM – ASSEGURAR MÁQUINA VAZIA	Dará este aviso ao iniciar uma calibração do kit de pesagem, com o objetivo de informar o utilizador de que a máquina de lavar tem que estar vazia, sem piso em cima, etc... antes de iniciar uma calibração. Nenhuma. Aviso meramente informativo. Botão de “OK” para ocultar o aviso e iniciar realmente a calibração.
CALIBRAÇÃO DE PESAGEM – PROCESSO EM MARCHA	Dará este aviso enquanto estiver a ser executada a calibração do sistema de pesagem. Nenhuma. Aviso meramente informativo. Não terá nenhum botão e será mostrado durante 5 segundos enquanto estiver a ser executada a calibração.
CALIBRAÇÃO DE PESAGEM – CALIBRAÇÃO INCORRETA	Dará este aviso quando terminar o processo de calibração e não tenha sido possível colocar corretamente a zero o sistema de pesagem. Nenhuma. Aviso meramente informativo. Botão de “OK” para ocultar o aviso.
CALIBRAÇÃO DE PESAGEM – NECESSIDADE DE CALIBRAÇÃO	Dará este aviso quando, ao premir “Start” para executar um programa de lavagem, seja medido um peso inferior em -3 Kg ou superior em 10 Kg ao nominal. Serão apresentadas as 2 opções “Cancel” ou “Ok”. Se premir “Ok”, continuará com o programa com o peso nominal. Se premir “Cancel”, abortará o programa.
EASY LOAD – INICIAR PROCESSO	Dará este aviso ao premir o botão de Easy Load no ecrã principal. O utilizador será informado de que deve introduzir a roupa e fechar a porta, e ser-lhe-á perguntado se quer iniciar o ciclo de Easy Load. Serão apresentadas as 2 opções “Cancel” ou “Ok”. Se premir “Cancel”, abortará o ciclo de Easy Load e regressará ao ecrã de seleção. Se premir “OK”, iniciará o ciclo de Easy Load.
EASY LOAD – CICLO EM EXECUÇÃO	Dará este aviso enquanto estiver a executar o ciclo de Easy Load, informando o utilizador de que este está a ser executado. Não dispõe de qualquer botão. Mensagem meramente informativa, o utilizador não poderá fazer nada mais do que esperar até que o ciclo seja finalizado.
LOAD DETECTION	Dará este aviso no princípio do programa de lavagem, quando a opção “pesagem inteligente” estiver ativada. Não dispõe de qualquer botão. Mensagem meramente informativa. Esta operação pode durar vários minutos.

Estes são os erros que podem ser apresentados na máquina de lavar:

ERRO	DESCRIÇÃO	CAUSA E AÇÃO
E1	CORTE DE ALIMENTAÇÃO ELÉTRICA DETETADO	Este erro será apresentado ao recuperar a tensão após ter-se registado um corte de alimentação durante a execução de um programa; a máquina retomará o programa onde parou automaticamente, mostrando uma mensagem de advertência durante 30 s. Serão apresentadas as opções "continuar" ou "finalizar". Se premir em "continuar", continuará a partir da fase em que a tensão foi cortada, mas começando a partir do início da fase. Se, pelo contrário, premir em "finalizar", o programa finalizará, desbloqueando a porta.
E2	FALHA NO BLOQUEIO	Este erro será apresentado ao iniciar um programa e não conseguir bloquear a porta ou ao desbloquear-se durante a execução do programa. O programa terminará e poderá voltar a tentar; certifique-se de que a porta está corretamente fechada. Se o erro persistir, contacte o seu serviço técnico.
E3	FALHA NO ESVAZIAMENTO / ÁGUA NA CUBA	Este erro será apresentado quando a máquina de lavar não for capaz de esvaziar a água do tambor; serão mostradas 2 opções "continuar" ou "finalizar". Certifique-se de que a saída de esvaziamento não está obstruída. Se a máquina estiver equipada com bomba de esvaziamento, limpe o filtro.
E4	NÍVEL MÁXIMO DE ÁGUA ALCANÇADO	Este erro será apresentado quando a máquina de lavar detetar um nível de água excessivo. Verifique se não entra água com a máquina de lavar em repouso. Em caso afirmativo, contacte o serviço técnico.
E5	FALHA DE ENTRADA DE ÁGUA	Este erro será apresentado quando a máquina de lavar detetar que não está a entrar água. Antes de contactar o serviço técnico: Certifique-se de que a válvula de passagem está aberta. Comprove que a configuração de esvaziamento é a correta (válvula/bomba).
E6	FALHA NO AQUECIMENTO	Este erro será apresentado quando a máquina de lavar não conseguir aquecer a água corretamente. Antes de contactar o serviço técnico, comprove que a configuração de aquecimento é a correta.
E7	TEMPERATURA MÁXIMA SUPERADA	Este erro será apresentado quando for detetada uma temperatura excessiva. Apenas será apresentada a opção de "finalizar". Ao premir, finalizará o programa, caso a temperatura seja inferior a 50°. Caso não seja assim, dará o error E11: ROUPA QUENTE
E8	ERRO DE MOVIMENTO	Este erro será apresentado quando a máquina de lavar não detetar movimento. Mostrará o aviso "O programa finalizará" e, passados 2 minutos, o botão OK aparecerá e, premindo-o, terminará o programa.

E9	DESEQUILÍBRIO	Este erro será apresentado quando a máquina de lavar não for capaz de equilibrar a roupa. Procure carregar a roupa de uma maneira mais homogénea.
E10	DESEQUILÍBRIO MÁX	Este erro será apresentado quando a máquina de lavar detetar um movimento excessivo durante a centrifugação. Se este erro for apresentado repetidamente, contacte o serviço técnico; poderá haver um problema com a instalação e/ou o amortecimento.
E11	ROUPA QUENTE	Este erro será apresentado quando, ao terminar um programa, a temperatura no interior da cuba exceder os 50°C (122°F). Espere até que a temperatura desça abaixo dos 50°C (122°F) e o programa finalizará automaticamente.
E12	ERRO DESBLOQUEIO	Este erro será apresentado quando a máquina de lavar não conseguir desbloquear a porta ao finalizar um programa. O erro é apresentado após terem sido efetuadas 3 tentativas de desbloqueio a cada 20 segundos. Apenas terá a opção de "finalizar". Ao premir esta opção, voltará a tentar e, caso não consiga, continuará a dar erro. Não force a porta e contacte o serviço técnico; este dar-lhe-á instruções para abrir a porta de forma segura.
E23	ERRO NA PESAGEM.	Este erro será apresentado quando a máquina de lavar detetar um erro de comunicação com o dispositivo de pesagem. Contacte o serviço técnico. Serão apresentadas as duas opções "OK" e "Cancelar". Premindo "Cancelar", abortará a execução do programa regressando à seleção. Premindo "OK", continuará com a execução do programa com o valor de peso nominal da máquina.
E25	ERRO DE COMUNICAÇÃO CONTROLO-CONTROLO AUX	Este erro será apresentado quando a máquina de lavar detetar um erro de comunicação com o cartão auxiliar utilizado em diversos acessórios. Contacte o serviço técnico. Serão apresentadas as duas opções "OK" e "Cancelar". Premindo "Cancelar", abortará a execução do programa regressando à seleção. Premindo "OK", continuará com a execução do programa, ignorando a função do acessório correspondente.
E26	ERRO DE TÉRMICO MOTOR	Este erro será apresentado quando a máquina de lavar detetar uma temperatura excessiva do motor. Contacte o serviço técnico.
E27	ERRO NTC FORA DO INTERVALO	Este erro será apresentado quando a máquina de lavar detetar uma temperatura fora do intervalo. O sensor de temperatura estará desligado ou danificado. Contacte o serviço técnico. Serão apresentadas 2 opções: "OK" ou "Cancelar". Premindo "OK", continuará com o programa, ignorando o aquecimento, e premindo "Cancelar", finalizará o programa.
E28	ERRO SENSOR DE PRESSÃO FORA DO INTERVALO	Este erro será apresentado quando a máquina de lavar detetar um nível de água fora do intervalo. O sensor de pressão estará desligado ou danificado. Contacte o serviço técnico. Este erro não terá nenhum botão disponível e só será possível abortar desligando a máquina.

SELF SERVICE V2.0

6	INTRODUÇÃO.....	35
7	INTERFACE.....	35
7.1	Ecrã de seleção 1 - Botões.....	35
7.2	Ecrã de seleção 2 - Pagamento	36
7.3	Impulsos de moedas e “Credit mode”	36
7.4	Ecrã de execução.....	37
8	PROGRAMAS	38
8.1	Biblioteca de programas	38
9	CONFIGURAÇÃO	39
9.1	Gestão de programas	39
9.2	Configurar Sistema	39
9.2.1	Configuração avançada	39
9.2.2	Programação HUD.....	45
9.2.3	Tabela de divisas	47
10	MANUTENÇÃO.....	49
10.1	Erros.....	49

6 INTRODUÇÃO

Nesta secção, são indicadas as características exclusivas para as máquinas de lavar self-service. É obrigatório ler os avisos de segurança e é necessário ler o resto do manual para compreender totalmente o funcionamento.

7 INTERFACE

7.1 Ecrã de seleção 1 - Botões

Quando a máquina for ligada, passa a *Ecrã de seleção 1*. Neste ecrã, temos 4 botões grandes fixos para poder seleccionar programas de lavagem.

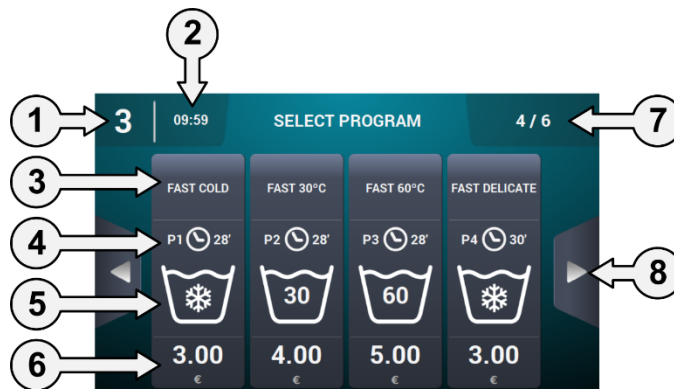

1. **Identificador da máquina:** É apresentada a etiqueta que identifica o aparelho com base na configuração existente (se estiver ativada).
2. **Hora:** Apresenta a hora atual no formato selecionado pelo utilizador.
3. **Nome do programa:** Nome configurado para o programa selecionado.
4. **Duração do programa:** Duração, em minutos, estimada para o programa selecionado.
5. **Temperatura programa:** Temperatura máxima entre as diferentes fases que compõem o programa.
6. **Preço:** Apenas em modo Coin, em CP e CR não será mostrado o preço, sendo mostrado um LED em seu lugar.
7. **Número de programas:** É apresentado o número de programas visualizados e o número de programas disponíveis. Por ecrã, é apresentado um máximo de 4 programas e o número máximo de programas a mostrar será de 16 (4 ecrãs de 4 botões).
8. **Setas laterais de navegação:** Caso tenha mais de 4 programas nos favoritos, são apresentadas as setas de navegação laterais, que permitem mostrar o ecrã de seleção seguinte.

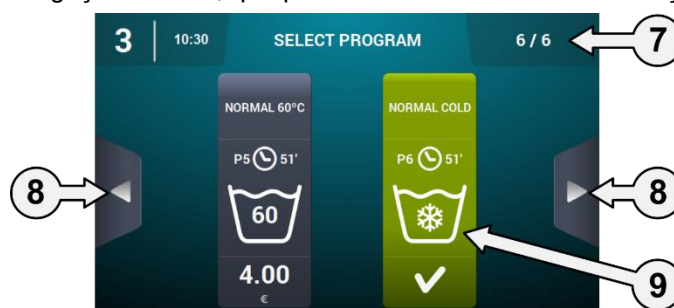

9. **Botão ativo:** Neste primeiro ecrã, poderá ser realizado o pagamento. Ao chegar o montante de um programa, o preço desaparecerá e a cor do botão muda a indicar que o programa está pronto a ser executado.

Ao premir um botão de programa, passa-se ao “Ecrã de seleção 2 – Pagamento”.

Quando terminar a execução de um programa, regressará a este ecrã.

De igual modo, mesmo que tenha tocado no ecrã ou tenha começado a introduzir dinheiro, se não houver atividade durante 15 minutos, regressa a este ecrã, com devolução do dinheiro que já tiver sido introduzido.

7.2 Ecrã de seleção 2 - Pagamento

Neste ecrã, é apresentada a mesma informação que no ecrã anterior, mas apenas do programa selecionado, acompanhado da animação e do texto de ajuda. Para além disso, há dois botões de navegação para poder alterar o programa.

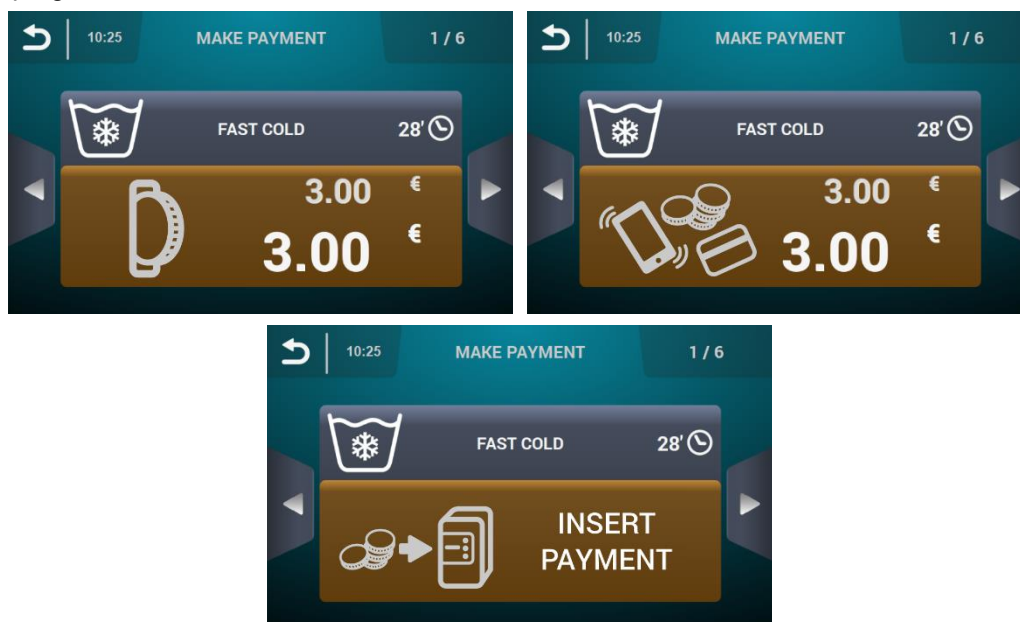

O botão será mostrado a castanho enquanto não for introduzido o montante indicado no programa.

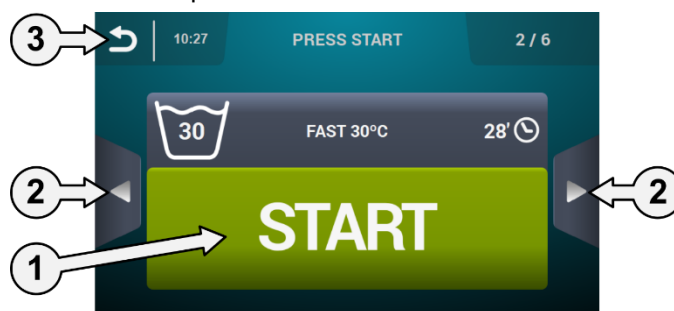

1. **Botão Start:** Ao chegar ao montante do programa, aparecerá o botão grande de “Start” a verde.
2. **Botões de navegação:** Permite mudar de programa.
3. **Botão de retrocesso:** Premindo este botão, regressamos ao ecrã principal “Seleção 1 – Botões”.

Se, após 15 minutos, não tiver havido atividade, o montante introduzido será reiniciado, perdendo o dinheiro e regressando ao ecrã “Seleção 1 – Botões”.

Ao premir o botão “Start”, o programa selecionado começa a ser selecionado.

7.3 Impulsos de moedas e “Credit mode”

Para poder executar qualquer programa, o pagamento correspondente terá de ser efetuado primeiro. Para isso, dependendo da configuração de self-service existente, controla a introdução de moedas (modo COIN) ou recebe o sinal correspondente no modo CP ou Multipagamento através da entrada “micro pagamento com moedas” para permitir a execução do programa selecionado.

Estando em modo de self-service (tanto no ecrã 1, como no 2 de seleção, como executando um programa de self-service), haverá a possibilidade de entrar em “Credit mode”. Se a entrada “painel aberto” for ativada nos modelos industriais ou se for acionada a chave do pagamento com moedas ou CP nos modelos profissionais, será pedida a palavra-passe para entrar em “Credit mode”.

Se entrar em “Credit mode”, sai automaticamente do modo self-service e age como se estivesse em modo normal, mostrando a informação definida no *Ecrã principal OPL* e dando a possibilidade de realizar todas as ações definidas nesse ecrã. São apresentados os programas selecionados para self-service e os programas definidos para Credit Mode.

Ao entrar no menu principal, são apresentadas as opções disponíveis para as máquinas de lavar em self-service.

Se a entrada "painel aberto" for desativada nos modelos industriais ou se for retirada a chave do pagamento com moedas ou CP nos modelos profissionais, sai automaticamente do "Credit mode". Se estivermos num ecrã secundário do menu principal (configuração, manutenção...) e saímos do "Credit mode", age como se estivesse em modo OPL, mostrando a informação definida no *Ecrã de execução OPL* e dando a possibilidade de realizar todas as ações definidas nesse ecrã.

7.4 Ecrã de execução

Ao premir o botão START, inicia o programa e apresenta o *Ecrã de execução*.

Estando em execução, também há a possibilidade de entrar em "Credit mode" da mesma forma explicada anteriormente. Se entrar neste modo, sai automaticamente do modo self-service e age como se estivesse em modo OPL, mostrando a informação definida no *Ecrã de execução OPL* e dando a possibilidade de realizar todas as ações definidas nesse ecrã.

No modo self-service, não há opção para avançar na fase ou colocar o programa em pausa, exceto se entrar no modo "Credit mode".

Também não estará, por predefinição, o botão START para permitir abortar um programa, ainda que possa ser ativado por intermédio de HUD.

Caso o botão STOP seja ativado, existe um período gracioso, no qual é possível abortar um programa sem perder o crédito introduzido. Se for abortado uma segunda vez dentro do período gracioso, perde-se o crédito.

Uma vez passado o período gracioso, será preciso realizar uma pressão prolongada de 3 segundos para abortar o programa e perde-se crédito.



1. **Identificador da máquina:** Etiqueta que identifica a máquina.
2. **Hora:** Horas e minutos no formato selecionado.
3. **Nome do programa:** Nome configurado para o programa selecionado.
4. **Número e duração do programa:** Posição do programa na lista de programas (Os meus programas) e a duração, em minutos, estimada do programa selecionado.
5. **Indicador de progresso do programa:** Estado do progresso do programa, relação entre o tempo total e o tempo restante do programa.
6. **Estado (desenho):** Desenho animado que mostra o que a máquina de lavar está a fazer (enchimento, esvaziamento, lavagem, enxaguamento, centrifugação ou descompactação).
7. **Fase em execução:** Identificador e nome da fase em execução
8. **Stop:** (desativado por predefinição): Botão para abortar o programa. Surge uma mensagem de confirmação.

8 PROGRAMAS

Apresenta uma biblioteca de programas composta por todos os programas predefinidos, assim como pelos programas criados pelo próprio utilizador.

8.1 Biblioteca de programas

Estes são os programas que existem predefinidos na biblioteca de programas:

- P1: Rápido frio
- P2: Rápido 30°C (86°F)
- P3: Rápido 60°C (140°F)
- P4: Rápido delicado

P1					
	8	2	2	2	6
	1	3	3	3	
	3	3	3	3	4
	0	0	0	0	
	15;05	15;05	15;05	15;05	
	✓	✓	✓	✓	
	✓	✓	✓	✓	
	✓	✓	✓	✓	
					✓
					✓
D	D2, D3			D4, D5	

P2					
	8	2	2	2	6
	30				
	1	3	3	3	
	3	3	3	3	4
	1	0	0	0	
	15;05	15;05	15;05	15;05	
	✓	✓	✓	✓	
	✓	✓	✓	✓	
	✓	✓	✓	✓	
					✓
					✓
D	D2, D3			D4, D5	

P3					
	8	2	2	2	6
	60				
	1	3	3	3	
	3	3	3	3	4
	1	0	0	0	
	15;05	15;05	15;05	15;05	
	✓	✓	✓	✓	
	✓	✓	✓	✓	
	✓	✓	✓	✓	
					✓
					✓
D	D2, D3			D4, D5	

P4					
	8	2	2	2	6
	2	4	4	4	
	2	2	2	2	3
	0	0	0	0	
	08;06	08;06	08;06	08;06	
	✓	✓	✓	✓	
	✓	✓	✓	✓	
	✓	✓	✓	✓	
					✓
					✓
D	D2, D3			D4, D5	

9 CONFIGURAÇÃO

9.1 Gestão de programas

Caso a máquina de lavar esteja configurada para o modo self-service, apenas estarão disponíveis os 16 primeiros programas, passando a estar disponíveis os restantes ao entrar em “Credit Mode”.







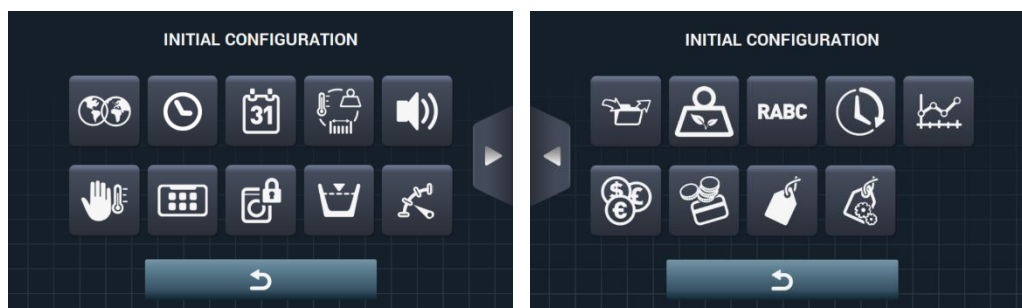

9.2 Configurar Sistema







9.2.1 Configuração avançada

Acesso: [Ecrã principal]  ⇒ [Menu Principal] 

Na configuração do sistema, será possível configurar as seguintes secções, tal como em “Credit mode” (Ver secção 4.2):



-  **Ecrã seguinte.**
-  **Ecrã anterior.**
-  **Idioma:** Os textos da máquina de lavar podem ser visualizados em 34 idiomas diferentes, mas a edição dos textos só pode ser efetuada com caracteres ocidentais.
-  **Hora:** Configuração da hora do momento. É possível selecionar o formato de visualização (12 horas/24 horas (predefinição)).
-  **Data:** Configuração da data do momento. É possível selecionar o formato de visualização (dd/mm/aaaa (predefinição) / aaaa/mm/dd / mm/dd/aaaa).
-  **Unidades de medida:** Permite selecionar a unidade de medida em que se pretende visualizar a temperatura (°C (predefinição) ou °F), o peso (Kg (predefinição) ou Lb) e o tamanho (mm (predefinição) ou in).
-  **Paragem térmica:** Configuração geral da paragem térmica. Se estiver desativada, a paragem térmica não será realizada, mesmo que a fase em execução tenha ativo o referido parâmetro. Se, pelo contrário, estiver ativada, será respeitada a configuração de cada fase, agindo-se em conformidade. Predefinição: ativada.
-  **Poupança de água na pesagem:** É possível configurar a poupança de água pretendida para a pesagem, podendo optar entre 3 opções diferentes de pesagem e 3 níveis de poupança. Dependendo da carga, haverá uma redução ou outra no nível de água e doseamento de detergente.
-  **Níveis:** Permite a configuração em mm dos 5 níveis configuráveis. Cada tipo de nível terá um valor predefinido e um intervalo de configuração, valores que dependerão do modelo selecionado. (Ver tabela de níveis por modelo).

- 
Velocidade: Permite a configuração das RPM dos diferentes tipos de velocidades existentes, tanto na lavagem como na centrifugação. Cada tipo de velocidade terá um valor mínimo e máximo de configuração. (Ver tabela de equivalências RPM/V por modelo).
- 
Importar/Exportar Configuração: Permite importar uma configuração de máquina a partir de uma memória USB ou exportar para uma memória USB a configuração atual da máquina. Ao premir este botão, será apresentado um ecrã intermédio para selecionar se queremos importar ou exportar (tal como nos programas).
- 
Credit Mode: Si la lavadora está en modo autoservicio, se podrá configurar la contraseña para Credit Mode (1234 por defecto). Anote la contraseña y gúardela, si lo pierde póngase en contacto con el servicio de asistencia técnica.
- 
HUD: No modo self-service, também poderão ser configurados o *Ecrã principal* (o primeiro e segundo ecrãs de seleção) e o *Ecrã de execução*. (Ver secção 9.2.2).
- 
Beep: Opção que permite desativar o sinal sonoro. Predefinição: ativada.
- 
RABC/Rastreabilidade: Será registada a informação de cada lavagem, guardando a informação seguinte (Ver secção 4.2.).
- 
Período gracioso: Ao premir este botão, é mostrado um ecrã intermédio para poder ativar ou desativar o período gracioso e poder editar o valor entre 1 e 99 minutos (por predefinição, está ativado para 1 minuto).

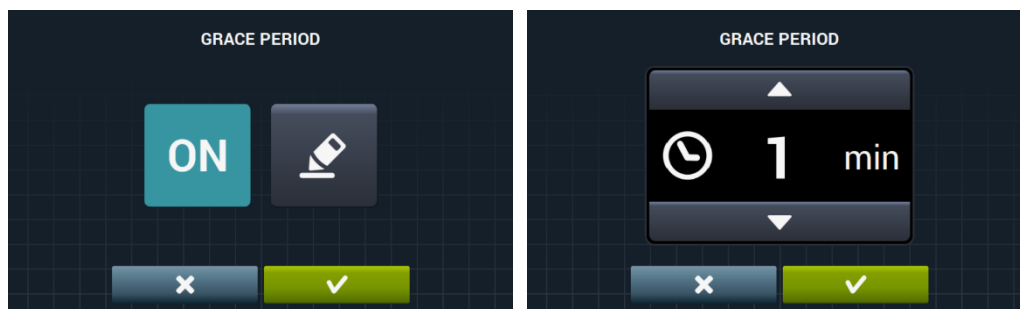

- 
Estatísticas de self-service: Permite obter dados de receitas e número de execuções de cada um dos programas favoritos. Ao premir o botão de estatísticas de self-service, é mostrado o seguinte ecrã.

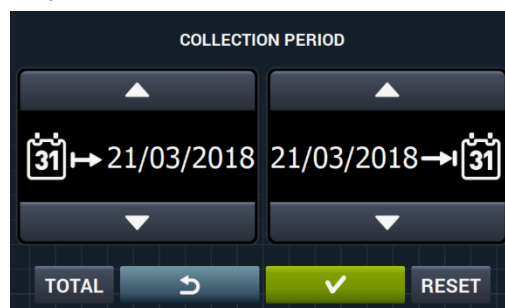

Premindo “TOTAL”, são mostrados os valores totais da máquina. Se for introduzida uma data, são mostradas as estatísticas apenas desse período. Premindo “Reset”, todos os valores são repostos a 0, reiniciando as estatísticas.

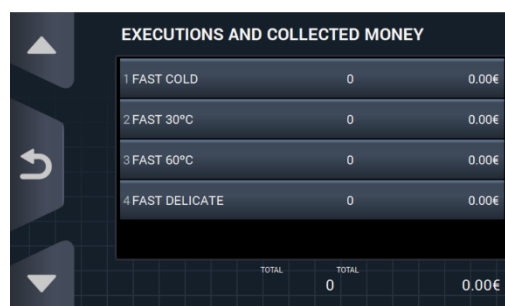



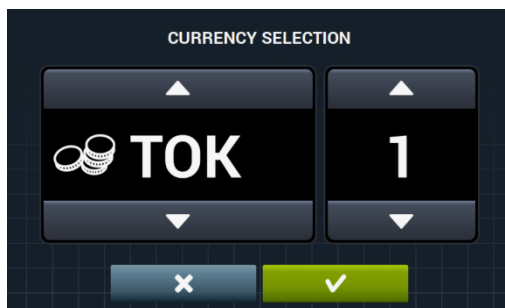

- 
Divisa: Permite seleccionar o tipo de divisa com que se pretende trabalhar e modificar o valor de impulso desta (ver secção 9.2.3). Se a divisa for alterada, todos os preços serão repostos, por predefinição, a token.

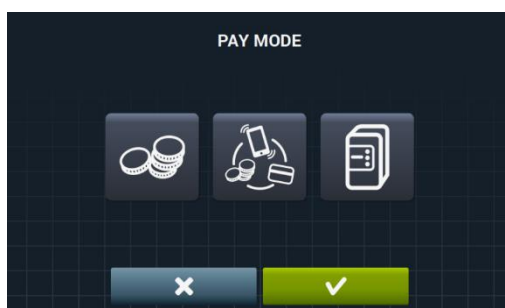



- 
Modo de Pagamento: Há 3 modos diferentes de trabalhar no modo self-service.



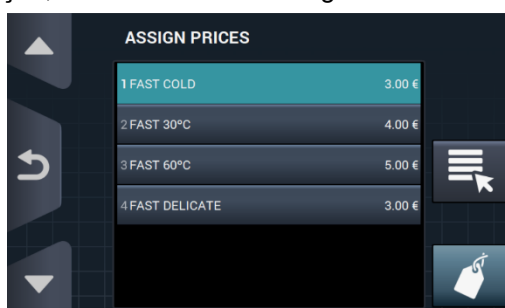

- 
COIN: É preciso configurar a divisa e o preço de cada programa, tratando os impulsos do pagamento com moedas a fim de permitir a execução de um determinado programa.
- 
Central Payment: A máquina de lavar receberá um impulso de uma central de pagamento para libertar a máquina e permitir a execução de um programa. Seleção predefinida. As opções de divisa, preço e programação de preços estão desativadas.
- 
Multipagamento: Mesmo comportamento que na opção "COIN".

- 
Preços: Podem ser configurados os preços de todos os programas seleccionados em "Os meus programas". O valor mínimo do programa será o múltiplo definido na divisa, enquanto o máximo será 100 vezes o valor do múltiplo. Por predefinição, o valor mínimo é configurável.

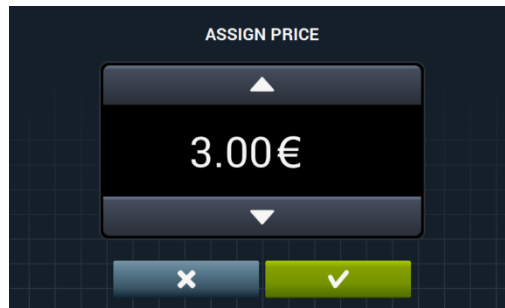

Seleccionamos o programa ou os programas que queremos modificar e, premindo o botão  passamos à janela para atribuir o preço novo.



-  **Programação de preços:** Para além da configuração básica de preços, haverá a possibilidade de realizar uma programação de preços, ou seja, períodos de tempo concretos durante os quais se pretende variar o preço definido dos programas. Máximo, 10 programações simultâneas.

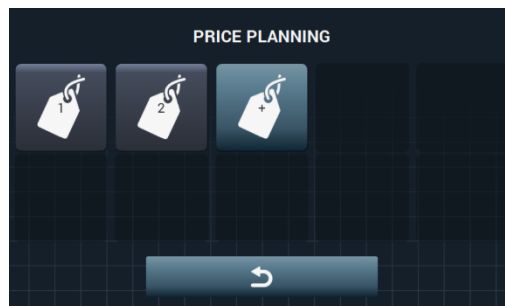

Os preços programados estarão em vigor durante o horário configurado, voltando aos preços gerais uma vez decorrido o horário configurado.

Se houver algum conflito entre diferentes programações, será aplicada a condição do primeiro plano. Além disso, só será permitido criar planos a partir da data atual.

Ao premir o botão  é criado um plano novo. Estes são os campos que é preciso preencher para efetuar uma programação:

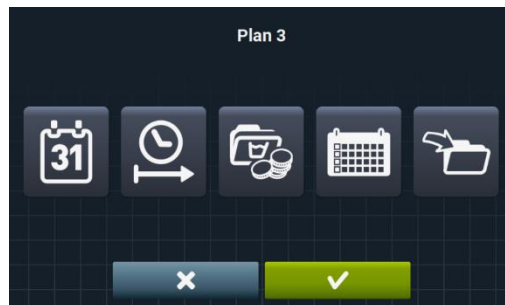

-  **Data:** Período de tempo durante o qual se pretende fazer a programação.

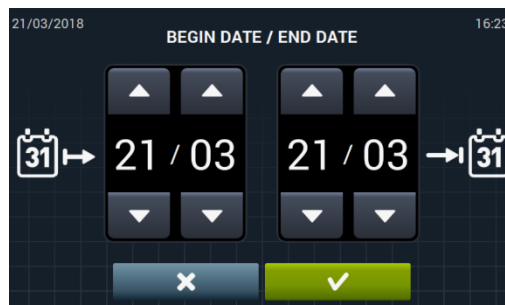

- 
Hora de início/fim: Hora de início e hora de fim da programação efetuada.

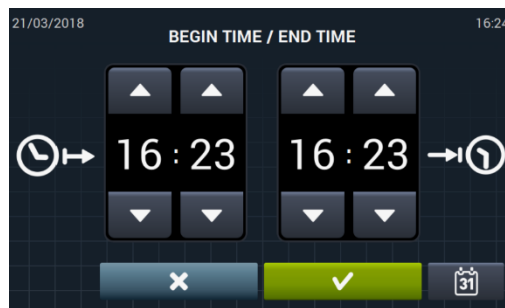

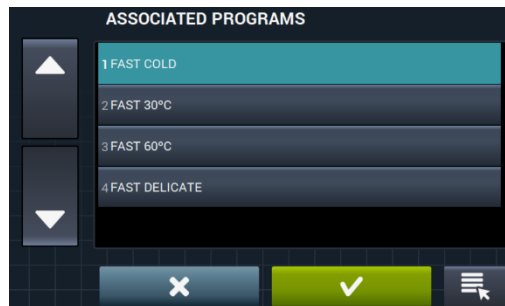

- 
Programa(s) & Preços: Preço ou desconto que se pretende atribuir a cada um dos programas existentes em "Os meus programas". Poderá ser atribuído um preço fixo ou aplicar um desconto aos programas selecionados.

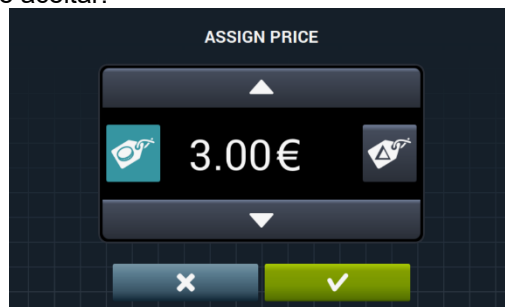

Para tal, seleccionamos o programa ou os programas aos quais se pretende aplicar a variação de preço e premimos de aceitar.



- 
Preço fixo: A todos os programas que seleccionámos será aplicado o preço definido.
- 
Desconto: A todos os programas que seleccionámos será aplicado o desconto definido.
- 
Calendário: Dentro da data indicada, os dias em que se pretende aplicar a programação efetuada.

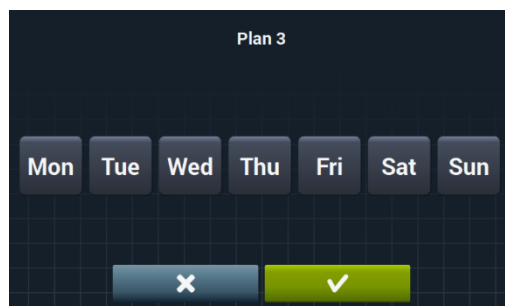

- 
Importar: Além da opção de preencher todos os campos um a um, é possível importar um plano já existente a partir de uma memória USB.

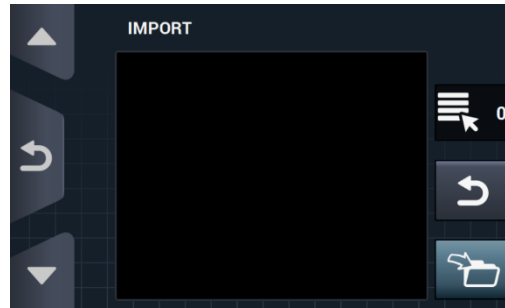

Se seleccionarmos IMPORTAR, será apresentado o mesmo ecrã que para os programas, para podermos navegar pela memória USB, mas apenas poderão ser seleccionados os ficheiros de planos de preços (extensão .plan). No momento de importar, só se poderá importar um plano. Depois de premir OK e importar o plano, regressa ao ecrã principal de planos de preços.

Premindo o botão de um dos planos ativos , apresenta um resumo dos parâmetros configurados.

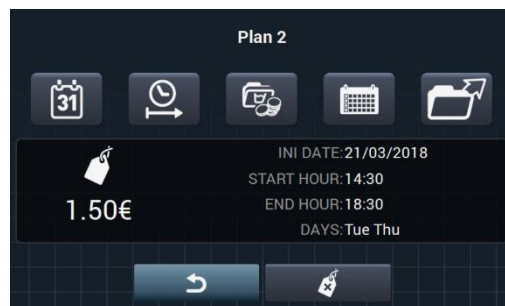

É possível alterar os parâmetros anteriormente descritos um a um premindo o botão correspondente.

Além disso, existe um botão "Exportar"  para poder exportar esse plano (num ficheiro com extensão .plan) para o diretório raiz da memória USB.

Os ficheiros dos planos de preços serão guardados numa pasta denominada "PRICE PLANS" no diretório raiz da memória USB.

Cada ficheiro de planos de preços terá a seguinte forma de denominação: PLAN_Nº_Fecha_hora.plan (PLAN_3_20151029_112346.plan por exemplo).

É possível eliminar o plano, premindo o botão de eliminar .

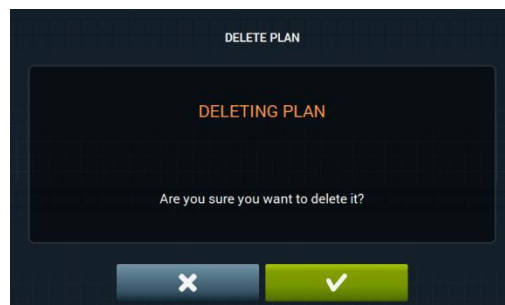

9.2.2 Programação HUD

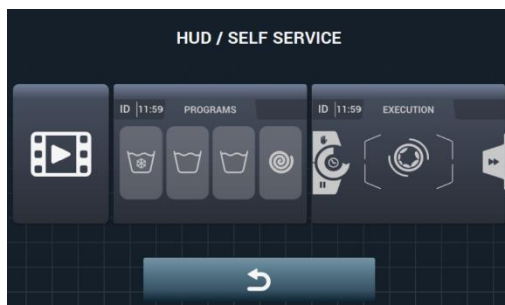

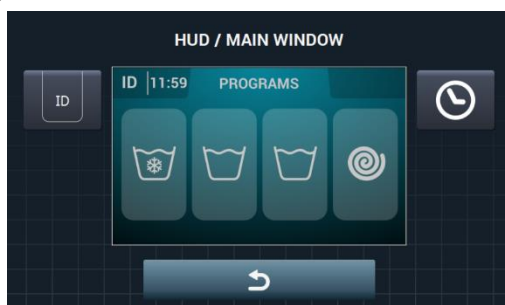

-  **Ecrã principal:** Será aplicável a ambos os ecrãs de seleção de self-service. Permite configurar os seguintes parâmetros:



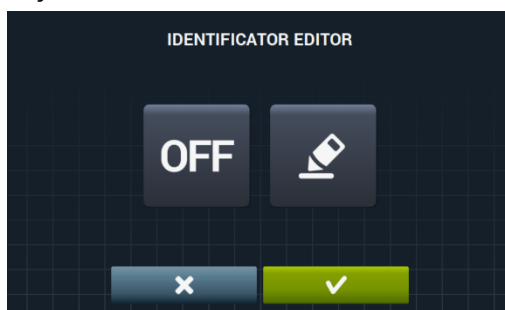

-  **Identificador da máquina:** É possível ativar/desativar e configurar a identificação da máquina. Predefinição: desativada.



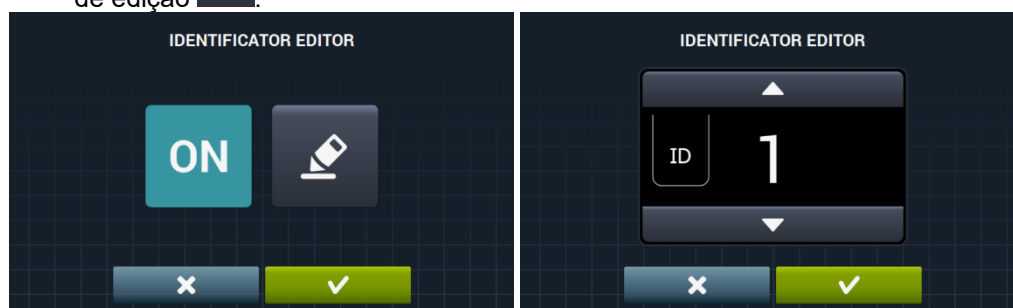



É possível ativar o identificador da máquina premindo o botão “OFF”  <> e depois o botão de edição .





-  **Hora:** Mostrar/ocultar hora atual. Predefinição: ativada.

-  **Ecrã de execução:** Seguem-se as opções que podem ser configuradas:

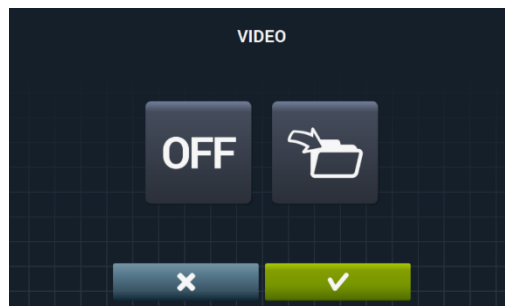

-  **Hora:** Opção que permite mostrar/ocultar a hora. Predefinição: ativada.
-  **Tempo restante:** Opção para mostrar/ocultar o tempo restante total e o indicador de progresso do programa. Predefinição: ativada.
-  **Identificador da máquina:** É possível ativar/desativar a identificação da máquina. Predefinição: desativada.
-  **STOP:** Permite mostrar o botão de paragem. Predefinição: desativada.
-  **Importar vídeo:** Permite reproduzir um vídeo no ecrã da máquina após 10 minutos de inatividade. Se “Poupança de energia” for ativada automaticamente, a reprodução do vídeo é desativada.



Premindo o botão importar , é possível importar um vídeo para a máquina a partir de uma memória USB externa; só poderão ser importados ficheiros de vídeo (avi, mov,...), e apenas poderá ser instalado um ficheiro de vídeo na máquina. A resolução recomendada dos vídeos será, para as máquinas com ecrã de 4,3” de 480x272 píxeis e para as máquinas com ecrã de 7” de 800x480 píxeis. Não é aconselhável que exceda os 16 Fps. O tamanho máximo do ficheiro não deve superar os 25 Mb.

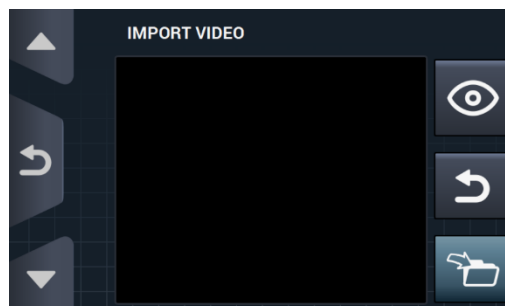

O botão de pré-visualização , permite verificar se a reprodução do ficheiro de vídeo é correta.

9.2.3 Tabela de divisas

Esta é a tabela de todas as moedas disponíveis com o correspondente símbolo e referência. Se for escolhido um valor de impulso diferente do valor predefinido, será preciso adaptar o pagamento com moedas a esse valor. É da responsabilidade do utilizador fazê-lo. Por predefinição, os pagamentos com moedas fornecidos têm de ser configurados para esses valores:

PAÍS	MOEDA	ISO	SÍMBOLO	Valor/IMPULSO
Token	Token	TOK	\$	1
Kuwait	Dinar do Kuwait	KWD	ك.د.	0,05
Omã	Rial de Omã	OMR	ر.ع.	
Azerbaijão	Manat	AZN	m	0,1
Bulgária	Lev	BGN	лв	
Bahrain	Dinar do Bahrain	BHD	ب.د.	
China	Yuan Chinês	CNY	¥	
Malásia	Ringgit Malaio	MYR1	RM	
Panamá	Balboa Panamiano	PAB	B	
Argentina	Peso Argentino	ARS	\$	
Bermudas	Dólar das Bermudas	BMD	BD\$	0,25
Brasil	Real	BRL	R\$	
Canadá	Dólar do Canadá	CAD	C\$	
Egito	Libra egípcia	EGP	ج.م.	
Etiópia	Birr etíope	ETB	Br	
Guatemala	Quetzal	GTQ	Q	
Ilhas Caimão	Dólar das Ilhas Caimão	KYD	\$	
Arábia Saudita	Riyal Saudita	SAR	ر.س.	
El Salvador	Colón de El Salvador	SVC	¢	
Turquia	Lira Turca	TRY	YTL	
Estados Unidos	Dólar USA	USD	\$	
Emiratos Árabes Unidos	Dirham dos UAE	AED	إ.د.	
Bolívia	Boliviano	BOB	Bs	
Estónia	Coroa da Estónia	EEK	EEK	
Países da Zona Euro	Euro	EUR	€	
Reino Unido	Libra esterlina	GBP	£	
Geórgia	Lari	GEL	ლარი	
Gana	Cedi ganês	GHS	GHS	
Croácia	Kuna Croata	HRK	kn	
Nova Zelândia	Dólar Neozelandês	NZD	\$	
Qatar	Riyal do Qatar	QAR	ق.ر.	
Ucrânia	Grivnia da Ucrânia	UAH	\$	
Singapura	Dólar de Singapura	SGD	S\$	
Malásia	Ringgit Malaio	MYR2	RM	

Bósnia e Herzegovina	Marco Convertível	BAM	KM	1
Bangladesh	Taka do Bangladesh	BDT	Tk	
Suíça	Franco Suíço	CHF	CHF	
República Dominicana	Peso Dominicano	DOP	RD\$	
Hong Kong	Dólar de Hong Kong	HKD	HK\$	
Israel	Shekel Israelita	ILS	₪	
Índia	Rupia indiana	INR	Rs.	
Sri Lanka	Rupia do Sri Lanka	LKR	₹	
Marrocos	Dirham marroquino	MAD	د.م.	
Macedónia	Dinar Macedónio	MKD	MKD	
Perú	Novo Sol Peruano	PEN	S/.	
Polónia	Zloty polaco	PLN	zł	
Federação Russa	Rublo Russo	RUB	руб	
Suécia	Coroa sueca	SEK	kr	
Tailândia	Baht tailandês	THB	฿	
Tunísia	Dinar tunisino	TND	ت.د.	
Uruguai	Peso Uruguaio	UYU	\$	
Sérvia	Dinar sérvio	RSD	дин.	
África do Sul	Rand sul-africano	ZAR	R	
Austrália	Dólar Australiano	AUD	\$	
República Checa	Coroa Checa	CZK	Kč	5
Dinamarca	Coroa Dinamarquesa	DKK	kr	
Quênia	Xelim queniano	KES	KSh	
México	Peso mexicano	MXN	\$	
Noruega	Coroa Norueguesa	NOK	kr	
Roménia	Leu romeno	RON	L	
Filipinas	Peso Filipino	PHP	\$	
Argélia	Dinar argelino	DZD	د.ج.	10
Guiana	Dólar da Guiana	GYD	GY\$	
Hungria	Florim Húngaro	HUF	Ft	
Islândia	Coroa islandesa	ISK	kr	
Cazaquistão	Tengue do Cazaquistão	KZT	T	
Taiwan	Dólar de Taiwan	TWD	NT\$	
Chile	Peso Chileno	CLP	\$	
Costa Rica	Colon da Costa Rica	CRC	₡	50
Irão	Rial Iraniano	IRR		
Paraguai	Guarani paraguaio	PYG	\$	
Polinésia Francesa	Franco CFP	XPF	F	
Colômbia	Peso Colombiano	COP	\$	100
Indonésia	Rupia Indonésia	IDR	Rp	
Japão	Iene japonês	JPY	¥	
Coreia do Sul	Won coreano	KRW	₩	
Uganda	Xelim ugandês	UGX	USh	
Venezuela	Bolivar	VEF	Bs.	

10 MANUTENÇÃO

10.1 Erros

A seguir, indicamos os erros que têm ações diferenciadas para self-service; os restantes são iguais.

ERRO	DESCRIÇÃO	CAUSA E AÇÃO
E6	FALHA NO AQUECIMENTO	É detetado que, apesar de ativar a saída de aquecimento, a temperatura da água não aumenta durante 30 minutos. É possível anular este erro. Neste caso, em vez de dar erro, avançará como se tivesse atingido a temperatura. Apresenta um aviso, mas não para; prossegue com o programa, mas o aviso permanece até que o programa termine e a porta seja aberta.
E9	DESEQUILÍBRIO	Na distribuição da centrifugação final, a entrada "Interruptor desequilíbrio" é ativada 5 vezes. Não dá erro e centrifuga a baixa velocidade; o programa termina normalmente, sem avisos.

ТЕХНИКА БЕЗОПАСНОСТИ	2
1 ЭКСПЛУАТАЦИЯ	5
1.1 Рекомендации по эксплуатации	5
1.2 Использование дозатора.....	5
1.3 Характеристики машины	5
2 ИНТЕРФЕЙС	6
2.1 Дисплей ВЫКЛ OPL	6
2.2 Главный дисплей OPL.....	6
2.3 Рабочее окно OPL	7
3 ПРОГРАММЫ	10
3.1 Параметры цикла	10
3.1.1 Параметры циклов замачивания, предварительной стирки, стирки или ополаскивания:.....	10
3.1.2 Параметры циклов отжима:.....	12
3.2 Библиотека циклов	13
3.3 Библиотека программ	15
4 НАСТРОЙКИ	16
4.1 Управление программами	17
4.1.1 Мои программы (любимые).....	17
4.1.2 Библиотека программ	18
4.1.3 Библиотека циклов.....	21
4.2 Системные настройки	22
4.2.1 Настройка HUD	26
5 ОБСЛУЖИВАНИЕ	30
5.1 Электронные и механические сбои	30
5.2 Предупреждения	30

ТЕХНИКА БЕЗОПАСНОСТИ

Чтобы избежать поражения током или травмирования в ходе работы с прибором, соблюдайте следующие меры предосторожности:

- Перед началом работы **ПРОЧТИТЕ** все руководство и **СОХРАНИТЕ ЕГО** в легкодоступном месте для обращения в случае сомнения.
- **НЕ** стирайте в машине одежду, которая была обработана, постирана, замочена или загрязнена горючим, раствором для химчистки или иным воспламеняемым или взрывоопасным веществом, пары которого могут воспламениться или взорваться.
- **НЕ** добавляйте горючее, раствор для химчистки или иные воспламеняемые вещества в воду для стирки. Пары этих веществ могут взорваться или воспламениться.
- При определенных условиях газообразный водород может образоваться в системе горячей воды, которая не использовалась более двух недель. Газообразный водород опасен. Если система подачи горячей воды долго не использовалась, а также перед использованием машины откройте все вентили горячей воды и подождите несколько минут, пока застоявшаяся вода стечет. Это поможет вывести скопившийся газообразный водород. Так как газ легко воспламеняется, то запрещается в это время курить или разжигать открытый огонь.
- Этой машиной могут пользоваться дети от 8 лет, а также люди с ограниченными физическими, сенсорными или умственными способностями, или без наличия знаний и навыков, при условии их соответствующего обучения или контроля, как использовать машину безопасным способом, а также при условии, что они понимают возможные риски. Уборку или обслуживание машины, выполняемые оператором, не должны выполнять дети без контроля.
- **НЕ** позволяйте детям играть на или внутри машины. За детьми, находящимися рядом с работающей машиной,

необходим постоянный надзор. Дети младше 3-х лет не должны находиться вблизи машины без наблюдения.

- Перед утилизацией или выводом машины из эксплуатации снимите ее люк.
- **НИ В КОЕМ СЛУЧАЕ НЕ ПЫТАЙТЕСЬ ОТКРЫТЬ ЛЮК** во время движения барабана.
- **НЕ** устанавливайте и не храните прибор на открытом воздухе.
- **НЕ** прикладывайте чрезмерное усилие к средствам управления.
- Необходимо использовать новые шланги, поставляемые в комплекте с машиной. Не используйте старые шланги.
- **НЕ** пытайтесь починить или заменить запчасти или выполнить обслуживание, если только это не прописано в Руководстве Пользователя. Убедитесь, что у вас достаточно опыта для осуществления описанных действий и что вы полностью усвоили руководство.
- **НЕ** снимайте защитные устройства и не вносите изменения в компоненты стиральной машины. **НЕ УСТАНАВЛИВАЙТЕ** на машину посторонние запчасти и устройства.
- Несоблюдение инструкций Руководства Пользователя может привести к травмированию пользователя. Все потенциальные аварийные и внештатные ситуации невозможно предвидеть и описать в предупреждениях о рисках и опасностях. Следовательно, лицо, осуществляющее перевозку, установку, эксплуатации или обслуживание прибора, должно всегда прибегать к здравому смыслу, осторожности и аккуратности.
- **НЕ** включайте машину, если ее защитные ограждения и устройства не установлены на места и не закреплены.
- Дистрибьютор (продавец) **ОБЯЗАН** надлежащим образом проинструктировать пользователя в ходе пусконаладочных работ.

- Добавляйте в дозатор моющего средства нужное количество порошка, кондиционера, указанное производителем. Обращайте внимание на рекомендации по стирке тканей, данные производителями.
- Ежедневно удаляйте остатки порошка и жидкости из дозаторов. Ни в коем случае не используйте для очистки порошковые или абразивные средства; пользуйтесь только мылом с водой.
- Раз в месяц прочищайте водозаборные фильтры и внешние трубки дозатора.
- Ни в коем случае не оmyвайте машину снаружи струей воды, так как она может попасть на функциональные компоненты и вывести машину из строя.
- Если планируется длительная пауза в эксплуатации машины, нанесите на ее поверхности из нержавеющей стали слой вазелинового масла.
- Раз в год рекомендуется проводить общий осмотр машины.

1 ЭКСПЛУАТАЦИЯ

1.1 Рекомендации по эксплуатации

В машине можно стирать и обрабатывать большинство материалов. Использование машины в целях, отличающихся от прописанных, является неприемлемым и нецелевым.

Загружайте в машину положенный номинальный вес белья, не закладывайте больше или меньше установленного веса. Не стирайте одежду в мешках или матерчатых сумках. При необходимости еще раз убедитесь, что в машину загружен номинальный вес белья - это предотвратит возможный дисбаланс.





Не отжимайте грубые полотна, водонепроницаемые изделия, ветошь, ковры и шерстяные изделия.

По завершении программы, перед тем, как люк будет открыт, изделия распутываются в течение 30 секунд. Как только данный процесс завершается, раздается звуковой сигнал, сообщающий о том, что люк можно открыть.

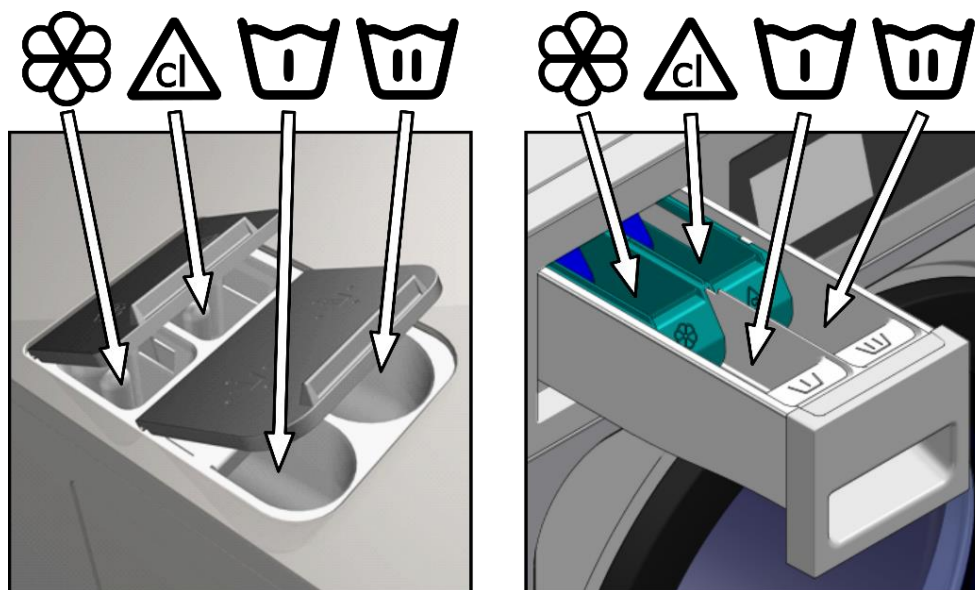
1.2 Использование дозатора

Залейте порошок в каждый отсек и закройте крышку дозатора.



-  Порошок для предварительной стирки
-  Порошок для стирки
-  Жидкий кондиционер
-  Жидкий отбеливатель (хлорка)

1.3 Характеристики машины

Машина управляется микропроцессором, регулирующим ее параметры согласно нуждам клиента.

Температура воды также регулируется системой управления; если горячая вода есть, она должна быть подключена. Машина регулирует забор воды через различные отверстия таким образом, чтобы поддерживать заданную температуру.

Система управления регулирует и циклы отжима. Система также отслеживает разбалансированное белье и циклы отжима, благодаря чему достигается высокое качество отжима, снижается уровень шума и увеличивается эксплуатационный срок подверженных износу запчастей и снижается усталостное напряжение.

2 ИНТЕРФЕЙС

Все стиральные машины оснащены сенсорным дисплеем, на который выводится все информация, и с которого можно управлять машиной.

Когда машина включена, на дисплее отображается сообщение "Экран ВЫКЛ". При нажатии кнопки ВКЛ/ВЫКЛ осуществляется переход на Главное окно, с которого можно запустить программу, или перейти в Главное меню. Нажмите СТАРТ, чтобы перейти к рабочему окну, в котором отображается необходимая информация.

Нажмите кнопку ВКЛ/ВЫКЛ, чтобы перейти из текущего окна в режим "Дисплей ВЫКЛ".

Информация, отображаемая в каждом окне, может быть пропущена или активирована в меню HUD (см. раздел 4.2.1)

2.1 Дисплей ВЫКЛ OPL

Когда машина отключена, показывается данное окно с заданными пользователем значениями параметров

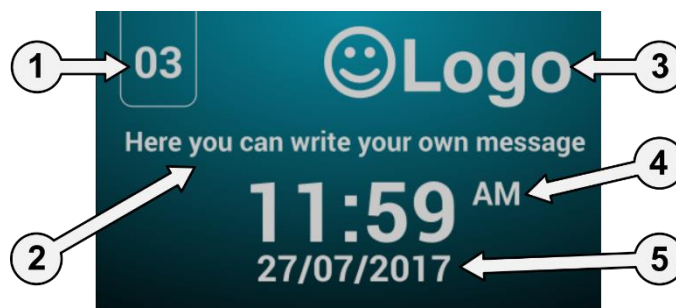

1. **Идентификация прибора:** Ярлык-идентификатор прибора (если присутствует).
2. **Сообщения для прачечной самообслуживания:** Сообщения, созданные пользователем (если активированы).
3. **Логотип:** Отображается (если активирован).
4. **Время:** Часы и минуты в выбранном формате.
5. **Дата:** Отображается в выбранном формате (если активирован HUD).

Если активирована опция "энергосбережение", подсветка дисплея отключится через 10 минут после выключения стиральной машины. При касании какой бы то ни было части дисплея, его подсветка снова включается.

2.2 Главный дисплей OPL

На иллюстрации представлен главный дисплей стиральной машины, отображающий все наличествующие опции. Некоторые опции можно пропустить в меню HUD.



1. **Идентификация прибора:** Ярлык-идентификатор прибора.
2. **Время:** Часы и минуты в выбранном формате.
3. **Вес изделий:** Отображение веса загруженных изделий (если весы активированы), или номинального веса загружаемого белья для данной модели (если весы не активированы) и возможность изменить введенное значение веса изделий. Опция активируется/деактивируется в меню HUD. По завершении или прекращении программы возвращается значение номинальной загрузки машины.
4.  **Главное меню:** Доступ к главному меню стиральной машины, в котором настраиваются различные параметры.
5. **Имя программы:** Имя, выбранное для данной программы.
6. **Температура:** Максимальная температура из всех значений температур всех циклов программы.
7. **Номер и продолжительность программы:** Место программы в списке программ (Моипрограммы) и предположительная продолжительность выбранной программы в минутах.
8. **Уменьшение/увеличение номера программы:** Пролистывание списка программ. Положение программы изменяется не только с помощью кнопок, но и при нажатии на строки с информацией о программе (непосредственно над кнопкой).
9. **Старт:** Запуск выбранной программы с указанного цикла.
10. **Фазы программы:** Нажав на иконку выбранной программы, отобразятся составляющие программу фазы, вы сможете выбрать ту, с которой хотите начать. Помимо этого, можно сразу же настроить текущую программу - изменить параметры цикла (время, температура, уровень и порция порошка). Данные изменения не будут сохранены для последующих запусков программы.

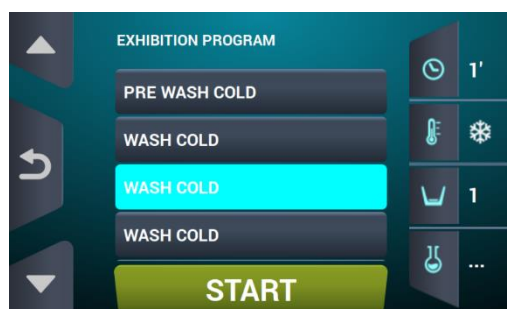

2.3 Рабочее окно OPL

При нажатии кнопки СТАРТ запускается программа и на дисплее отображается информация о запущенной программе. Некоторые опции можно пропустить в меню HUD.

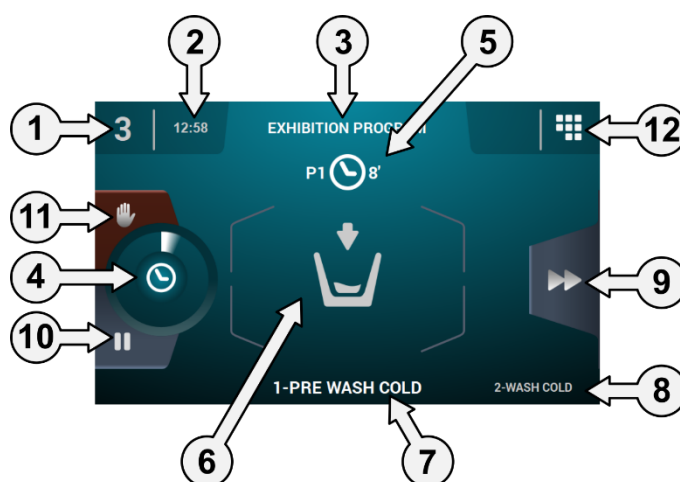



1. **Идентификация прибора:** Ярлык-идентификатор прибора.
2. **Время:** Часы и минуты в выбранном формате.
3. **Выполнение программы:** Имя программы, Номер программы, Продолжительность программы.
4. **Указатель выполнения программы:** Он указывает на состояние выполнения программы, отношение общего времени к оставшемуся.

5. **Номер и длительность программы:** Положение программы в списке программ (Мои программы), а также расчетная длительность в минутах выбранной программы.
6. **Состояние (рисунок):** Это анимированный рисунок, отображающий действие стиральной машины (заполнение, слив, стирка, полоскание, отжим или разглаживание).

	Открытие дверцы.		Наклон вперед.
	Нагревание		Наклон назад.
	Разглаживание.		Отжим.
	Охлаждение.		Окончание.
	Заполнение водой.		Стирка.
	Остановка.		Программа остановлена.
	Высушивание белья.		Слив.

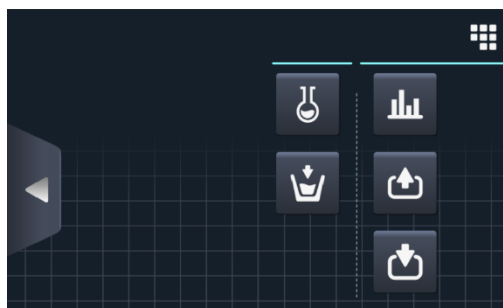
7. **Текущий цикл:** Иконка и имя текущего цикла.
8. **Следующий цикл:** Иконка, имя и схема следующего цикла (если текущий является последним, ничего не отображается).
9. **Ускорение цикла:** Кнопка для перехода на следующий цикл (если текущий является последним, ничего не отображается). Положение программы изменяется не только с помощью кнопок, но и при нажатии на строки с информацией о следующем цикле (непосредственно над кнопкой).
10. **Пауза:** Установка текущей программы на паузу. При установке паузы иконка паузы сменяет иконку выполнения программы. Программу можно возобновить с места прерывания.
11. **Стоп:** Кнопка для остановки и отмены программы. На дисплей выведется сообщение о подтверждении.
12.  **Меню выполнения:** Доступ к текущим параметрам.



-  **Входы:** Отображается состояние каждого входа. Всегда отображаются входы, доступные для всех машин. Входы, используемые для конкретных целей (самообслуживание, дезинфекция, дополнительные порции, баки (T1, T2, T3), наклон и др.) отображаются только при активации данных функций.

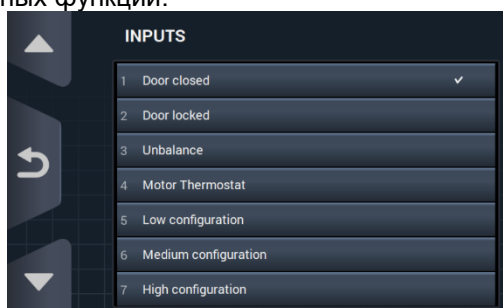

- 
Выходы: Отображается состояние каждого выхода. Всегда отображаются выходы, доступные для всех машин. Выходы, используемые для конкретных целей (самообслуживание, дезинфекция, дополнительные порции, баки (T1, T2, T3), наклон и др.) отображаются только при активации данных функций.

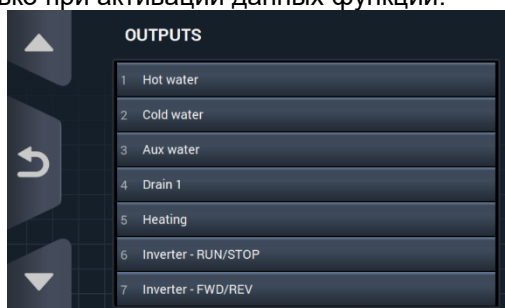

- 
Настройки/значения: Отображение заданных и текущих значений параметров данного цикла (температура, уровень, оставшееся время). Нажатием на кнопки в колонке справа можно редактировать заданные значения, которые будут действовать только в ходе выполнения программы.

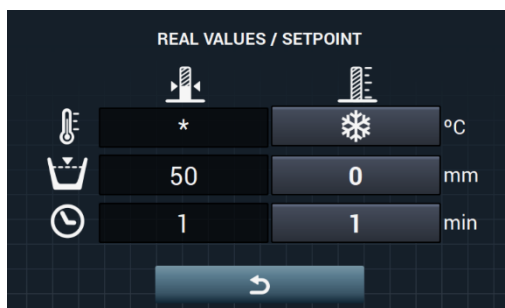

- 
Ручная дозация: При доступе в данный раздел отображается состояние каждого дозатора (ВКЛ/ВЫКЛ) и можно включить/отключить подачу нужной порции. Список доступных опций зависит от настроек установленных устройств. При выходе из меню дозирования все дозаторы отключаются.

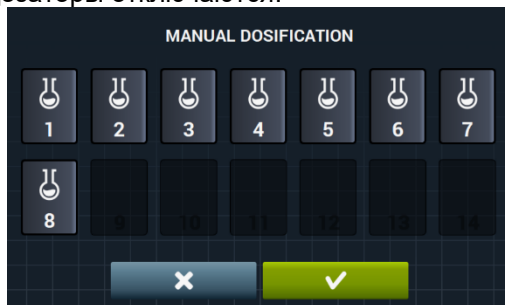

- 
Ручной выпуск воды: При входе в данный раздел отображается состояние каждого входа (ВКЛ/ВЫКЛ), при этом, каждый вход можно активировать/деактивировать. Впускное отверстие для воды, активированное для заполнения, не отключается. При выходе из меню забора воды, все водозаборные отверстия, активированные вручную, деактивируются.

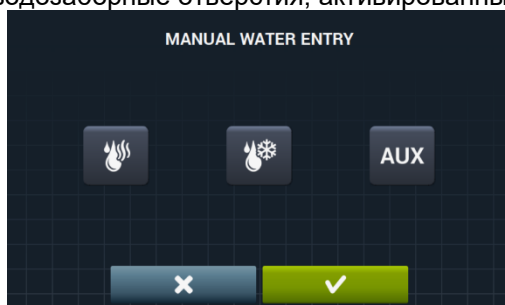

3 ПРОГРАММЫ





Библиотека программ содержит программы, установленные по умолчанию и созданные пользователем. Перед пояснениями к управлению программой (см. раздел 4.1) подробно рассматриваются параметры программ и стандартные программы, находящиеся в библиотеке.





3.1 Параметры цикла

Каждая программа состоит из серии циклов, параметры каждого из которых можно настроить в зависимости от типа цикла.

3.1.1 Параметры циклов замачивания, предварительной стирки, стирки или ополаскивания:



- Имя цикла:** Имя для обозначения цикла. Это не текст, отображаемый в окне выполнения программы, а наименование созданного цикла.
- 
Время: Продолжительность цикла в минутах. Диапазон: от 1 до 99.
- 
Температура: Температура выполнения данного цикла в °C или °F. Диапазон: от 20°C (68°F) до 90°C (194°F).
- 
Уровень: Уровень воды при данном цикле. Изменяемые пределы (см. раздел 4.2.). 5 уровней: Минимальный (1), низкий (2), средний (3), высокий (4), максимальный (5).
- 
Скорость: Скорость текущего цикла 4 скорости: Минимальная (1), низкая (2), стандартная (3), высокая (4).. Изменяемые пределы (см. раздел 4.2.).
- 
Скорость стирки: последовательность движения, которой должна следовать стиральная машина (время работы (сек.) / Остановленное время (сек.)). Настраиваемый диапазон от 1 до 99. Барабан будет вращаться попеременно влево и вправо.

- 
Впуск воды: Показывает выбор нужного водозаборного отверстия.
 - Горячая вода. Забор из впускного отверстия для горячей воды (Да/нет)
 - Холодная вода. Забор из впускного отверстия для холодной воды (Да/нет)
 - Дополнительно. Забор из вспомогательного впускного отверстия (Да/нет)
 - Регулировка забора воды. Забор воды из определенного отверстия в зависимости от температуры (да/нет)
 - T1, T2, T3: Забор воды из любого установленного бака регенерации.
- 
Слив: Слив воды в конце цикла и указание на сливное отверстие, которое используется при наличии комплекта регенерации.
- 
Охлаждение: Понижение рабочей температуры цикла перед сливом или переходом к следующему циклу. Настраивается, только если температура цикла равна или выше 40°C (104°F). Диапазон: от 30°C (86°F) до установленной температуры цикла. Помимо функции установки температуры охлаждения, есть кнопка активации/ деактивации данной опции.
- 
Дозатор 1.8: Каждый дозатор активируется отдельно, и после активации необходимо настроить следующие параметры:
 - Старт: Если дозатор X активирован, необходимо указать момент начала дозирования





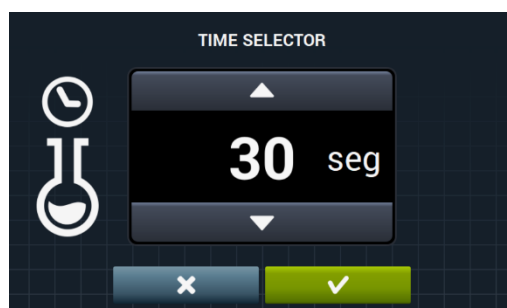

- Уровень безопасности (ML): Дозирование начинается по достижении уровня безопасности.
 - Уровень (L): Дозирование начинается по достижении заданного уровня.
 - Температура (T): Дозирование начинается по достижении заданной температуры.
- Продолжительность: Продолжительность работы дозатора X. Регулируется от 0 до 99.

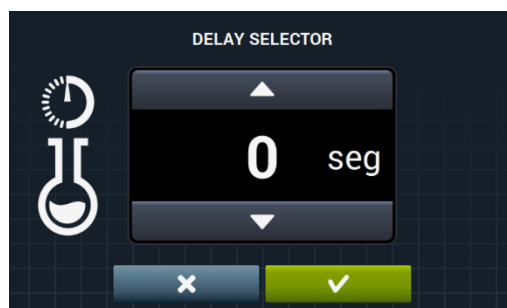





- Задержка: Задержка запуска дозатора X (в секундах). Задержка запуска на указанное время отсчитывается с момента достижения заданных параметров запуска. Диапазон: от 0 до (разница между продолжительностью цикла и продолжительностью дозирования).

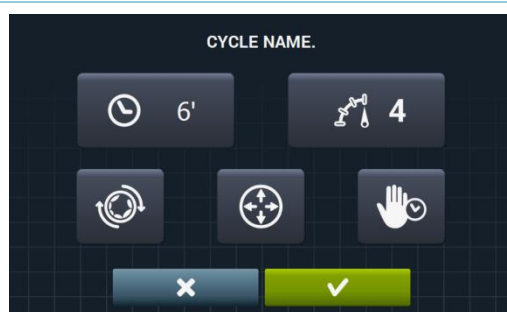

-  **Вращение при заполнении:** Вращение барабана в ходе заполнения машины (да/нет).
-  **Вращение при сливе:** Вращение барабана в ходе слива (да/нет).
-  **Термостоп:** Момент начала отсчета заданного времени цикла (да/нет).
-  **Пауза программы:** Установка программы на паузу перед началом выполнения данного цикла. На дисплей выводится иконка паузы и раздается звуковой сигнал (да/нет). Если данный параметр активирован, то перед запуском цикла устанавливается пауза и выводится сообщение "Пауза программы". Чтобы продолжить выполнение программы, нажмите кнопку PLAY.

3.1.2 Параметры циклов отжима:

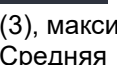
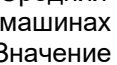







-  **Время:** Продолжительность цикла в минутах. Диапазон: от 1 до 99.
-  **Скорость:** Скорость отжима 4 скорости: Минимальная (1), стандартная(2), средняя (3), максимальная (4). Средняя (3) и максимальная (4) скорости есть только на высоко- и среднескоростных машинах соответственно. Значение регулируется.
-  **Распутывание:** Распутывание в конце цикла отжима (да/нет).
-  **Оптимальное распределение:** При активации данной опции, вода после предыдущего цикла не сливается.
-  **Пауза программы:** Установка программы на паузу перед началом выполнения данного цикла. На дисплей выводится иконка паузы и раздается звуковой сигнал. (да/нет).

3.2 Библиотека циклов

В библиотеку внесено несколько циклов по умолчанию. Их можно использовать для создания новых программ.

- Циклы замачивания
 - **F1:** Замачивание
- Циклы предварительной стирки
 - **F2:** Нормальная предварительная стирка в холодной воде
 - **F3:** Нормальная предварительная стирка при 40°C (104°F)
 - **F4:** Деликатная предварительная стирка в холодной воде
 - **F5:** Деликатная предварительная стирка при 40°C (104°F)
 - **F6:** Очень деликатная предварительная стирка в холодной воде
 - **F7:** Очень деликатная предварительная стирка при 40°C (104°F)
 - **F8:** Влажная предварительная стирка
- Циклы стирки
 - **F9:** Нормальная стирка в холодной воде
 - **F10:** Нормальная стирка при 60°C (140°F)
 - **F11:** Нормальная стирка при 90°C (194°F)
 - **F12:** Деликатная стирка в холодной воде
 - **F13:** Деликатная стирка при 40°C (104°F)
 - **F14:** Очень деликатная стирка в холодной воде
 - **F15:** Очень деликатная стирка при 40°C (104°F)
 - **F16:** Влажная стирка в холодной воде
 - **F17:** Влажная стирка при 40°C (104°F)
- Циклы ополаскивания
 - **F18:** Нормальное ополаскивание
 - **F19:** Нормальное финальное ополаскивание
 - **F20:** Деликатное ополаскивание
 - **F21:** Деликатное финальное ополаскивание
 - **F22:** Очень деликатное ополаскивание
 - **F23:** Очень деликатное финальное ополаскивание
 - **F24:** Влажное ополаскивание
 - **F25:** Влажное финальное ополаскивание
- Циклы отжима
 - **F26:** Быстрый отжим
 - **F27:** Долгий отжим

Иконки циклов:

	Циклы замачивания	
	Циклы предварительной стирки	 : Предварительная стирка в холодной воде,  40: Предварительная стирка при 40°C (104°F), ...
	Циклы стирки	
	Циклы ополаскивания	 : Ополаскивание,  : Финальное ополаскивание с кондиционером
	Циклы отжима	

Обозначения и величины параметров:























































































	Продолжительность	Значение в минутах
	Температура	Значение в °C (°F)
	Уровень	1: минимум, 2:низкий, 3: средний, 4:высокий. 5:максимум
	Скорость стирки	(1), низкая (2), стандартная (3), высокая (4).
	Скорость отжима	2:нормальная, 3:высокая, 4:максимальная
	Впуск воды	0:холодная, 1:холодная/горячая, согласно настройкам
	Ход стирки	Продолжительность стирки (в секундах), Продолжительность паузы (в секундах).
	Вращение при заполнении	✓ : Да
	Термостоп	✓ : Да
	Вращение при сливе	✓ : Да
	Слив:	✓ : Да
	Охлаждение	✓ : Да
	Оптимальное распределение	✓ : Да
	Останов программы	✓ : Да
	Распутывание	✓ : Да
D	Дозатор	Впуск порции порошка (D1:Дозатор 1, ...)при заданных значениях СТАРТА/ПРОДОЛЖИТЕЛЬНОСТИ/ЗАДЕРЖКИ, МЛ/0/30.

Таблица циклов с параметрами:

	F1		F2		F3		F4		F5		F6		F7		F8
			 ❄️	 40		 ❄️		 40		 ❄️		 40		 ❄️	
	3		5	5	5		6	6	6		6	6	6		5
	3			40			40		40			40			
	3		1	1	1		3	3	3		3	3	3		3
	0		3	3	3		2	2	2		2	2	2		1
	15;05		0	1	0		1	1	0		0	1	1		0
	✓		15;05	15;05	10;08		08;06	5;15	5;15		5;15	5;15	02;02		
	✓		✓	✓											✓
	✓		✓	✓											✓
				✓				✓				✓			
			✓	✓											✓
			✓	✓	✓		✓	✓	✓		✓	✓	✓		✓
D		D	D1	D1	D1	D	D1	D1	D1	D	D1	D1	D1	D	D1

	F9	F10	F11	F12	F13	F14	F15	F16	F17
	10	10	10	12	12	12	12	10	10
		60	90		40		40		40
	1	1	1	1	1	1	1	2	2
	3	3	3	2	2	2	2	1	1
	0	1	1	0	1	0	1	0	1
	15;05	15;05	15;05	10;08	10;08	05;15	05;15	02;02	02;02
	✓	✓	✓					✓	✓
		✓	✓		✓		✓		✓
	✓	✓	✓					✓	✓
	✓	✓	✓	✓	✓	✓	✓	✓	✓
D	D2, D3	D2, D3	D2, D3	D2	D2	D2	D2	D2	D2

	F18	F19	F20	F21	F22	F23	F24	F25
	2	2	3	3	3	3	2	2
	4	4	4	4	4	4	4	4
	3	3	2	2	2	2	1	1
	15;05	15;05	10;08	10;08	05;15	05;15	02;02	02;02
	✓	✓					✓	✓
	✓	✓					✓	✓
	✓	✓	✓	✓	✓	✓	✓	✓
D		D4		D4		D4		D4

	F26	F27
	2	6
	2	4
	✓	✓
	✓	✓

3.3 Библиотека программ

В библиотеку внесено несколько программ по умолчанию:

P1: Энергичная, 90°C (194°F)	P10: Очень деликатная, холодная вода
P2: Энергичная, 60°C (140°F)	P11: Экономная, 90°C (194°F)
P3: Энергичная, 30°C (86°F)	P12: Экономная, 60°C (140°F)
P4: Энергичная, холодная вода	P13: Экономная, 30°C (86°F)
P5: Нормальная, 60°C (140°F)	P14: Экономная, холодная вода
P6: Нормальная, 30°C (86°F)	P15: Слив
P7: Нормальная, холодная вода	P16: Долгий отжим
P8: Деликатная, 40°C (104°F)	P17: Быстрый отжим
P9: Деликатная, холодная вода	



Таблица всех программ с параметрами находится на последних страницах этого руководства.

4 НАСТРОЙКИ

Ниже показано главное меню настроек стиральной машины. В нем можно настроить различные параметры стирки, вывести на дисплей или скачать сохраненные данные.

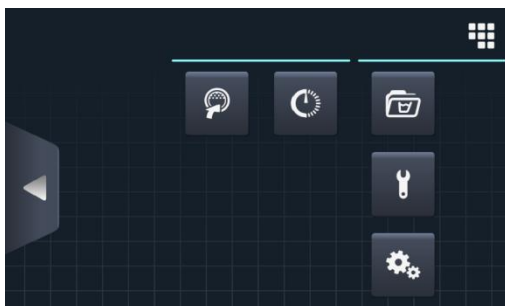
Вход в данное меню осуществляется при нажатии на иконку  в **Главном окне** (см. раздел 2.2).





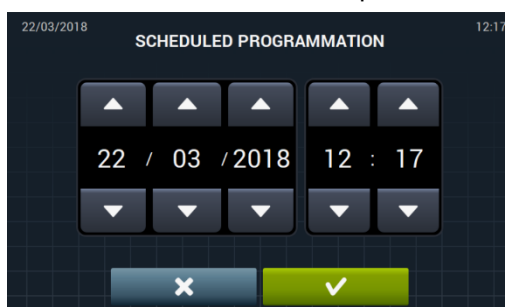

-  **Easy load:** опция, помогающая загрузить в машину белье.
-  **Программирование с задержкой:** Позволяет запрограммировать выполнение стирки на желаемую дату/время. После нажатия на кнопку «программирование с задержкой», появится экран для введения желаемой даты/времени.

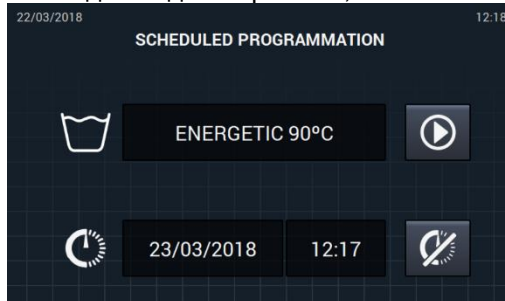

С переходом с экрана введения даты/времени, а также с номером и названием программы.



-  Выполнить программу до заданного времени.
-  Отменить выполненное программирование.
-  **Управление программой:** Управление сохраненными и активированными программами. (См. раздел 4.1)
-  **Настройка системы:** Настройка различных устройств стиральной машины. (См. раздел 4.2)
-  **Обслуживание:** Опции защищены паролем, доступны только технику.



4.1 Управление программами

Здесь можно регулировать положение программ, как созданных пользователем, так и установленных по умолчанию. Для этого выберите "Библиотека циклов", "Мои программы" и "Библиотека программ".

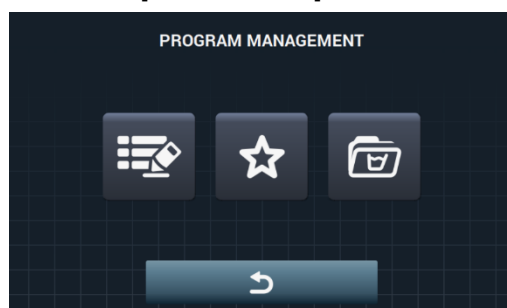
Доступ [Главное окно]  ⇒ [Главное окно] 





Библиотека содержит циклы и программы, созданные пользователем и установленные по умолчанию.

-  **Мои программы:** Они располагаются на главном экране OPL. (см. раздел 4.1.1).
-  **Библиотека программ:** (см. раздел 4.1.2).
-  **Библиотека фаз:** (см. раздел 4.1.3).

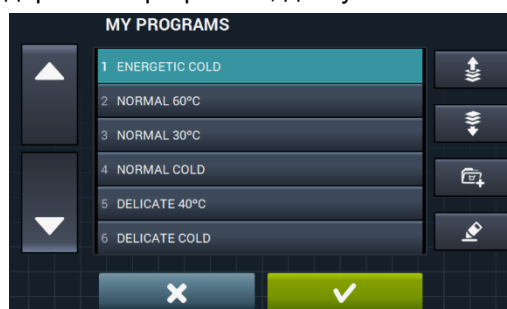

4.1.1 Мои программы (любимые).

В папке "Мои программы" содержатся программы, доступные на Главном окне OPL.

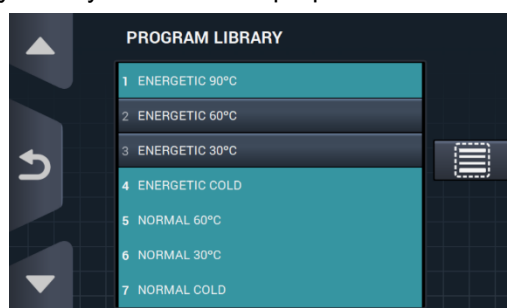

-  **Добавить/удалить программы:** Нажатием на кнопку вы перейдете в библиотеку программ. На этом экране отображаются программы, добавленные в «Мои программы», вы можете выбрать/отключить по одной программе, которые необходимо добавить/исключить из списка любимых.
 -  **Выбрать/отключить все:** Галочка будет проставлена или убрана по всему списку библиотеки программ.



-  **«стрелка вверх»** и  **«стрелка вниз»:** При помощи них вы можете менять положение любой любимой программы, устанавливая их в желаемый порядок.

- 
Кнопка редактировать: При помощи этой кнопки вы можете редактировать выбранную программу, как будто находясь в библиотеке программ.



Нажмите ОК или вернитесь в "Мои программы".

4.1.2 Библиотека программ

Программы можно добавлять, копировать, изменять или удалять, импортировать новые программы или экспортировать программы через USB-устройство.

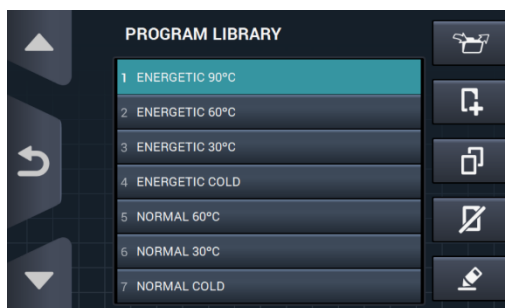

- 
Создание программы: Создание новой программы стирки с использованием циклов из библиотеки. При нажатии данной кнопки пользователь должен задать имя новой программы.

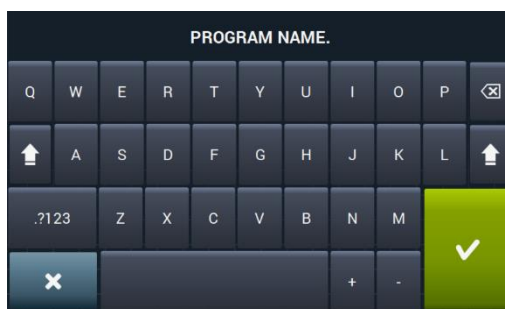

Отображается следующее окно (без циклов), куда можно добавить циклы из библиотеки циклов.

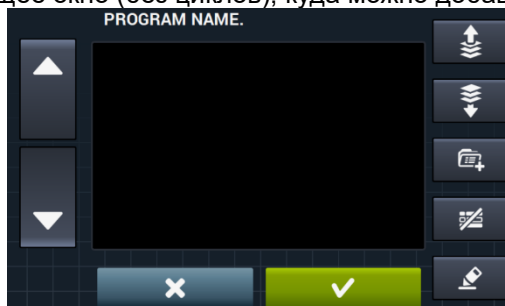





- 
Циклы добавляются из библиотеки. Циклы, которые вы желаете просмотреть, можно отфильтровать по типу.





Выбрав цикл из библиотеки, просмотрите его параметры перед включением их в создаваемую программу.





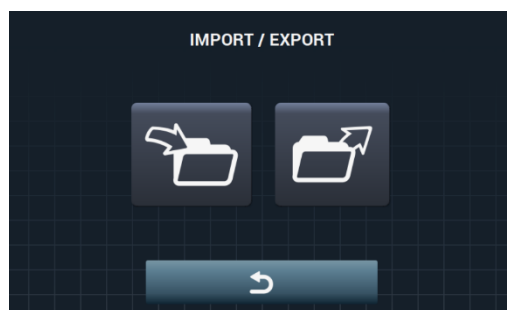

Каждая программа состоит из параметров, сгруппированных в циклы, не связанные с другими циклами в библиотеке.

- 
Копировать программу: Копирование программы из библиотеки с присвоением ей нового имени.
- 
Редактировать программу: Редактирование имени и циклов программы. Добавление, редактирование, удаление или изменение порядка существующих циклов. В ходе редактирования, как и при создании новой программы, можно добавлять/удалять циклы, содержащиеся в библиотеке. При создании программ допускается только просмотр параметров циклов. Циклы, уже находящиеся в программе, можно редактировать только при редактировании программ.
- 
Удаление программы: Удаление программы из библиотеки.
- 
Импорт/экспорт программы: Позволяет импортировать/экспортировать программы из внешнего USB-накопителя.



- 
Импорт программы: Импортирование новых программ с USB-носителя. В USB-накопителе, помимо папок, отобразятся только файлы с расширением “. prg”.

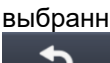

-  **Индикатор:** Отображает номер выбранных программ.
-  **Выбрать/отключить все:** Выбрать или отключить все программы в выбранной папке.
-  **Назад:** Позволяет выйти из папки.
Если имя импортируемой программы совпадает с именем уже существующей, появится предложение переименовать программу, или отменить действие. Так как подобная ситуация может случиться с несколькими программами одновременно, то есть кнопка "то же самое для всех".
-  **Экспорт программы:** Экспорт программ из библиотеки на USB-устройство.



Программы, подлежащие экспорту, можно выбрать.

-  **Выбрать/отключить все любимые:** Позволяет выбрать все программы, или все любимые программы с постоянным указанием количества выбранных программ.

Выбранный набор программ будет сохранен в папке "PROGRAMS" в корневой папке USB носителя, каждая программа будет представлена отдельным файлом.

4.1.3 Библиотека циклов

Имя каждого цикла можно отредактировать в библиотеке циклов. Имя изменяется после того, как оно вводится в программу в режиме показа информации о цикле. Имя состоит из типа фазы и параметра (темп., об/мин).

Библиотека циклов редактируется, циклы можно создавать, изменять, копировать и удалять (см. раздел 3.1).



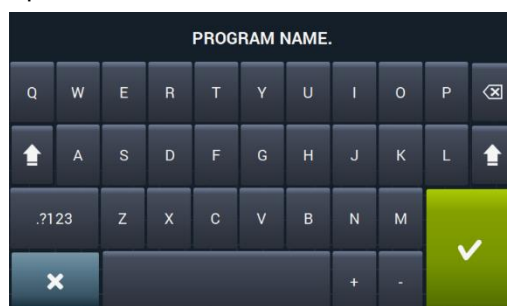

-  **Создать фазу:** Создание новых фаз стирки. Нажатие этой кнопки сначала позволит ввести номер новой программы.

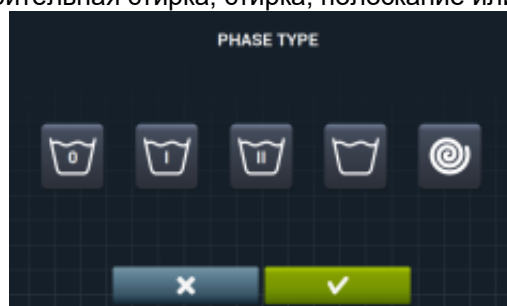

Далее отобразится следующий экран, с которого можно выбрать тип создаваемой фазы: замачивание, предварительная стирка, стирка, полоскание или отжим.







-  **Скопировать фазу:** Позволяет скопировать существующую в библиотеке фазу с присвоением нового названия.
-  **Удалить фазу:** Удаление фаз, хранимых в библиотеке.
-  **Изменить фазу:** Изменение параметров выбранной фазы.

4.2 Системные настройки

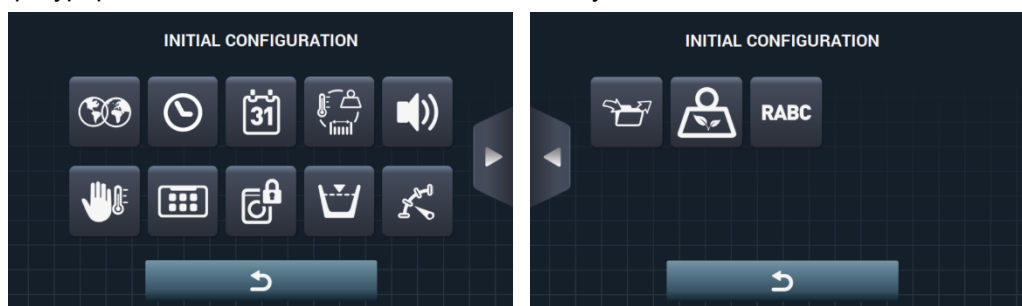
Доступ [Главное окно]  ⇒ [Главное меню] 

При конфигурировании системы можно изменить следующее:



-  Следующий экран.
-  Предыдущий экран.
-  **Язык:** Тексты стиральной машины могут отображаться на 34 разных языках. Изменение текстов возможно только с использованием символов западноевропейских языков.

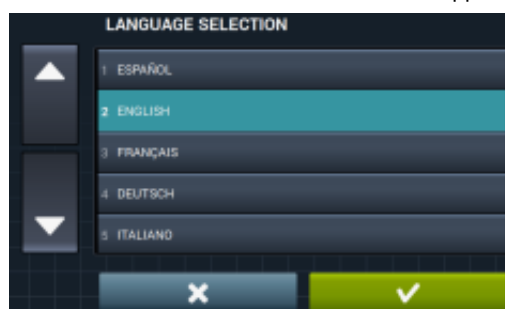

-  **Время:** Настройка текущего времени: Выберите формат времени (12 часов/24 часа (по умолчанию)).

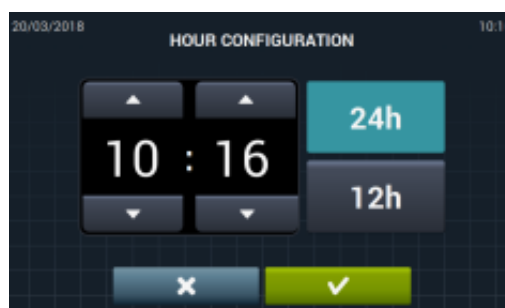

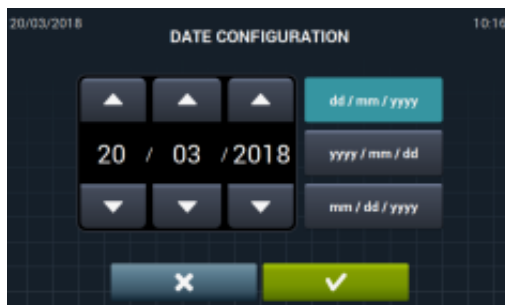

- 
Дата: Настройка текущей даты: Формат даты (дд/мм/гггг (по умолчанию) / гггг/мм/дд/мм/дд/гггг).







- 
Единицы измерения: Выбор единиц измерения температуры (°C (по умолчанию) или °F), веса (кг (по умолчанию) или фунты) и размеров (мм (по умолчанию) или дюймы).

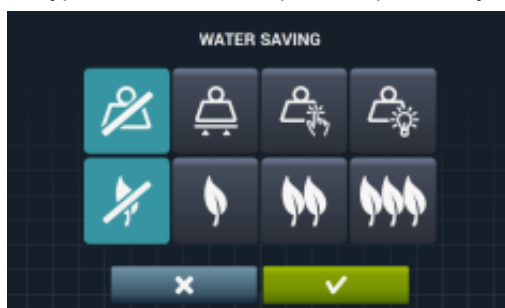





- 
Термостоп: Общая настройка функции термостоп. Если функция отключена, термостоп не осуществится, даже при наличии параметр активирован в текущем цикле. Если функция включена, она выполняется при сохранении всех настроек каждого цикла. По умолчанию функция активна. В машинах без нагревания (HW) эта функция будет неактивна.
- 
Удержание воды по весу: Существует возможность настроить желаемую экономию воды для взвешивания при помощи 3-х разнообразных опций взвешивания и 3-х уровней экономии. В зависимости от объема, уровень воды и порция порошка будут сокращены.

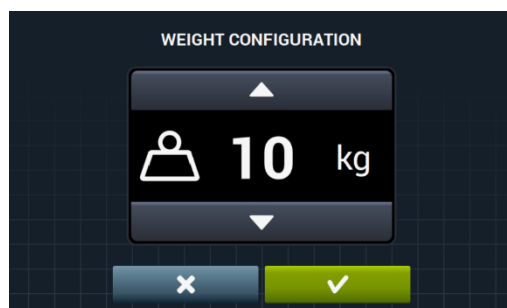

- 
 Опция взвешивания отключена.
- 
 Опция автоматического взвешивания доступна на основе конфигурации существующих.
- 
 Опция ручного взвешивания: вес белья будет введен вручную при помощи нажатия на иконку с весом на главном экране (см. раздел 2.2 пункт 3).
- 
 Опция умного взвешивания осуществляет расчет загрузки белья в начале выполнения любой программы. Сообщение LOAD DETECTION будет отображаться во время взвешивания. Процесс осуществления такого взвешивания может длиться несколько минут. Это время не входит в общее время выполнения программы.



-  Опция экономии воды отключена.
 -  Опция низкой экономии воды.
 -  Опция средней экономии воды.
 -  Опция высокой экономии воды.
-  **Уровни:** Настройка значения 5 уровней (в мм). Каждый уровень имеет собственное значение по умолчанию и диапазон регулирования значений. Значения зависят от выбранной модели (см. таблицу уровней в моделях).



-  **Скорость:** Настройка скорости (обороты в минуту) циклов стирки и отжима. Для каждой скорости установлены минимально и максимально возможные значения (см. таблицу скоростей (об/мин) в моделях).

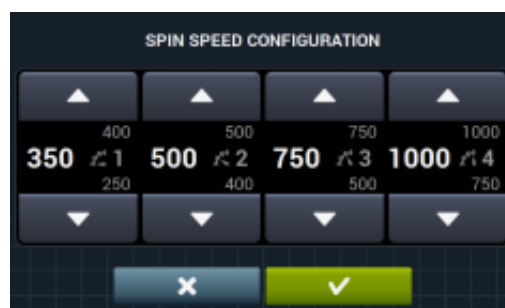
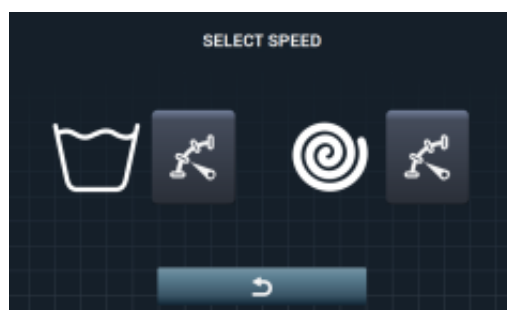

- 
Импорт/экспорт настроек: Настройки машины можно импортировать с USB-носителя, или экспортировать текущие настройки на запоминающее устройство. При нажатии данной кнопки появляется промежуточное окно, в котором нужно выбрать импорт или экспорт (как в меню программ)..

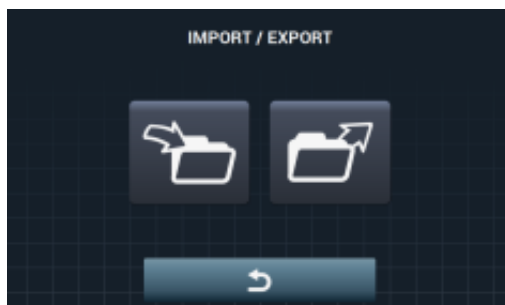

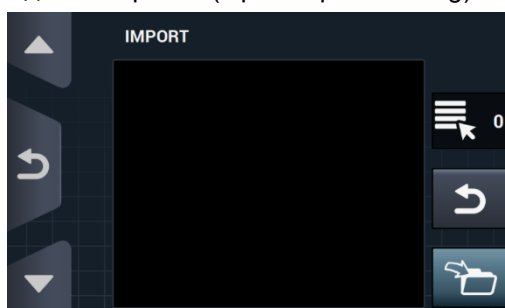

При выборе ИМПОРТ, появится экран отображения содержимого USB-накопителя. Вы сможете выбирать только файлы для настройки (с расширением .cfg).



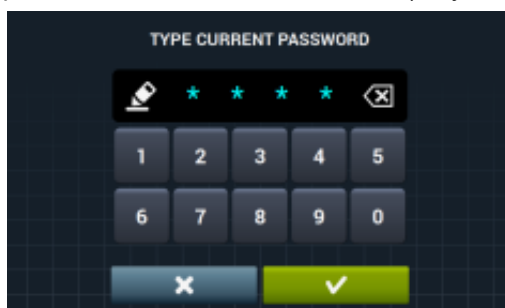

В случае выбора ЭКСПОРТ текущие настройки машины будут сохранены в корневой папке USB носителя в папке "CONFIGS". Каждому файлу настройки будет присвоено название в следующем виде: CONFIG_Модель_Дата_время.cfg.

- 
Ограниченный доступ: Установка в главном меню пароля, предотвращающего изменение настроек машины. По умолчанию пароль отключен. Здесь можно указать пароль для входа в главное меню (по умолчанию 1234).



- 
HUD: Настройка HUD позволяет активировать/деактивировать вывод параметров в окнах (см. раздел 4.2.1).



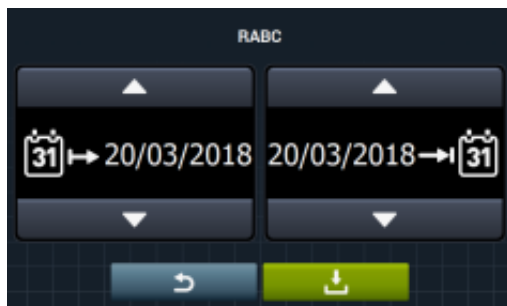

- 
Звуковой сигнал: Возможность отключения звукового сигнала. По умолчанию сигнал активен.
- 
RABC/отслеживание: Информация о каждой стирке регистрируется, и сохраняются следующие данные:
 в начале цикла: программа, время запуска, вес (где применимо). В ходе выполнения программы, каждые 15 секунд: Уровень, температура, ошибки (где применимо) При загрузке данных необходимо выбрать требуемый период (по умолчанию дата запуска и дата окончания, текущая дата).
 Минимальный период сохранения данных составляет 15 дней.
 После каждой выгрузки будет создаваться “RABC” в корневой папке USB носителя. Каждому файлу gabc будет присвоено название в следующем виде: RABC_Модель_Дата_время.gabc.



4.2.1 Настройка HUD

Настройка параметров, отображаемых на включенном дисплее, в главном и рабочем окнах, а также настройка автоматического отключения и энергосбережения.

Доступ: [Главный экран]  ⇒ [Главное меню]  ⇒ [Настроить систему] 



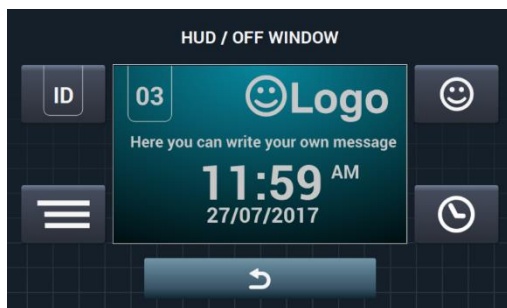

- 
Отключенный дисплей: Ниже перечислены регулируемые параметры:



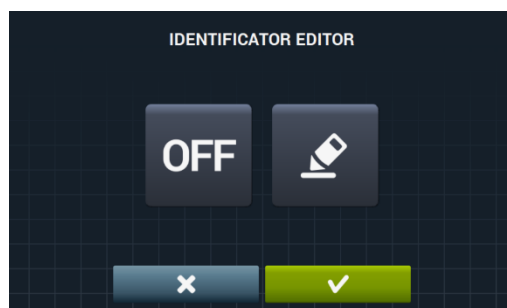

- 
Идентификатор машины: Идентификатор машины можно включить/отключить, номер на идентификаторе можно изменить (от 1 до 99). По умолчанию сигнал активен. Эта идентификация обязательна в случаях применения удаленного доступа.

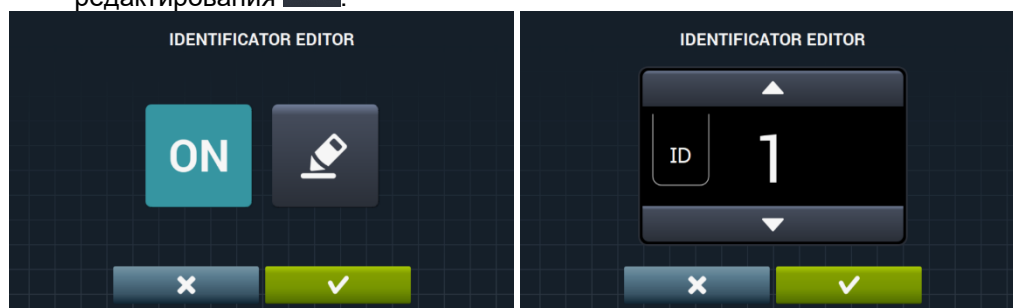

Получить такую идентификацию можно нажав на кнопку "OFF"  далее на кнопку редактирования .



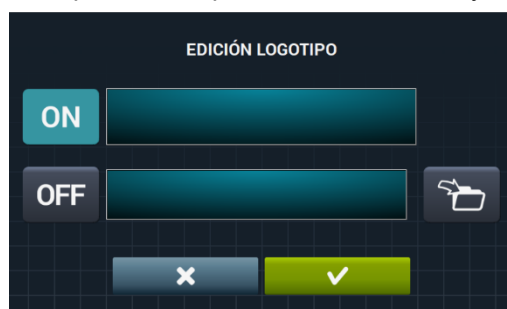

-  **Дата:** опция включается/отключается. По умолчанию сигнал активен.
-  **Логотип:** отображение/скрытие логотипа. По умолчанию отображается.

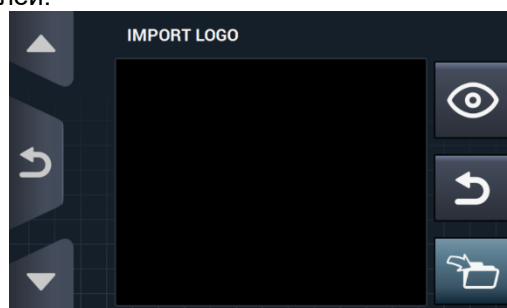

Нажатием на кнопку импорт , можно импортировать логотип машины с памяти внешнего USB-накопителя. Файл логотипа должен быть в формате .png с разрешением 290 x 80 пикселей.







При помощи кнопки предварительного просмотра , можно проверить правильность отображения логотипа.

-  **Сообщение для прачечной самообслуживания:** Начало сообщения, которое пользователь может изменить (до 40 символов). По умолчанию отключено.

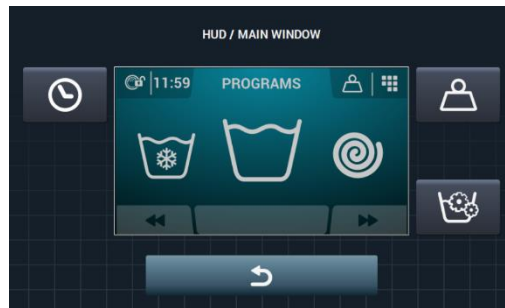

- **Главное окно:** Ниже перечислены регулируемые параметры:









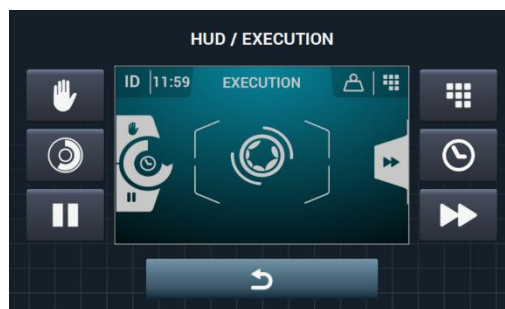

-  **Время:** отображение/скрытие времени. По умолчанию отображается.
-  **Вес изделий:** если опция отключена, иконка веса не отображается. По умолчанию отключена.
-  **Мгновенное программирование:** если функция отключена, параметры каждого цикла можно просматривать, но не редактировать. По умолчанию активна.





- **Рабочее окно:** Опции, отображаемые в рабочем окне:

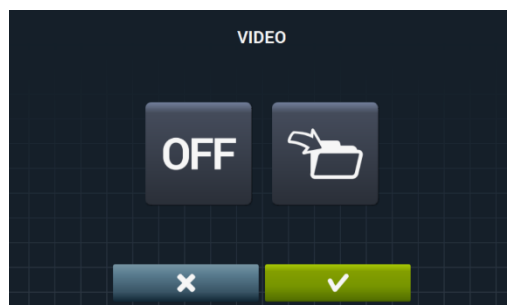

-  **Время:** Отображение/скрытие времени По умолчанию активна.
-  **Оставшееся время:** Отображение/скрытие общего оставшегося времени и индикатора выполнения программы. По умолчанию активно.
-  **Кнопка останова СТОП:** Скрытие кнопки останова По умолчанию активна.
-  **Кнопка ПАУЗЫ:** Скрытие кнопки паузы По умолчанию активна.
-  **Кнопка меню:** Отображение/скрытие иконки меню, по умолчанию функция активна.
-  **Кнопка ускорения:** Скрытие кнопки ускорения и информации о следующем цикле. По умолчанию активна.
-  **Автоматическое отключение:** Если данная опция активна, а главное окно открыто, дисплей отключается после 30 минут бездействия. По умолчанию функция активна.
-  **Энергосбережение:** Эта опция позволяет экономить энергию, выключая подсветку экрана спустя 10 минут после выключения стиральной машины. Если прикоснуться к какой-либо части машины, подсветка экрана вновь загорится и перейдет на главный экран. По умолчанию эта опция активирована.

-  **Импорт видео:** Эта опция позволяет воспроизводить видео на экране стиральной машины после 10 минут ее неактивного состояния. В случае активации «энергосбережения» опция воспроизведения видео отключится автоматически.



Нажатие на кнопку импорт , позволяет импортировать видео в стиральную машину с памяти внешнего USB-накопителя. В этом случае можно импортировать только видео (в формате (avi, mov,...)), при этом можно иметь только одно видео в стиральной машине. Рекомендуемое разрешение для видео для машин с экраном 4,3" составляет 480x272 пикселей, а для машин с экраном 7" — 800x480. Не рекомендуется превышать кадровую частоту размером 16. Максимальный размер файла не должен превышать 25 Мб.

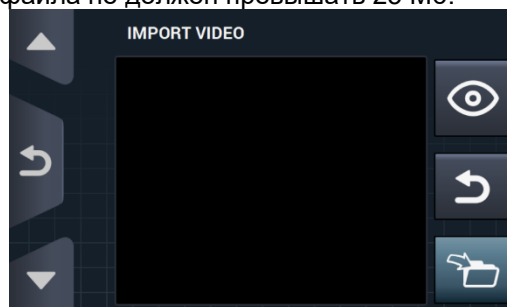

Кнопка предварительного просмотра , позволяет удостовериться в правильности воспроизведения видео.

5 ОБСЛУЖИВАНИЕ

5.1 Электронные и механические сбои

Перед обращением в центр обслуживания сделайте следующее:

- Убедитесь, что на машину подается питание
- Проверьте состояние предохранителей
- Убедитесь, что напряжение сети соответствует напряжению машины.

При недостаточном уровне воды проверьте

- Открыт ли водопроводный кран
- Не заблокирован ли водозаборный фильтр
- Находится ли давление воды в пределах 2-4 кг/см² (28 и 58 фунтов на кв.дюйм)

При чрезмерной вибрации стиральной машины убедитесь, что ни один винт панелей не откручен.

При сбое питания убедитесь, что вода из барабана слита и что люк заблокирован. Если необходимо извлечь белье из машины, разблокируйте люк, потянув вниз ремень, расположенный за передней панелью.

5.2 Предупреждения

Все предупреждения и ошибки выводятся на дисплей и сопровождаются звуковым сигналом. В случае ошибки информация о цикле и его состоянии сохраняется для возможности локализации ошибки.

Сообщения, выводимые на дисплей, приводятся ниже:

ОПИСАНИЕ	ПРИЧИНА И УСТРАНЕНИЕ
ДВЕРЦА ОТКРЫТА	Если в начале цикла дверца открыта, то данное сообщение появляется на дисплее и сопровождается 30-секундным звуковым сигналом. В этом случае будет активна только опция "ОК". Программа не будет запущена, а пользователь сможет повторить попытку.
ВОДА В БАРАБАНЕ	Данное сообщение появляется в конце программы, если уровень воды не находится на отметке 0 мм. На дисплей выводятся две опции: "Завершить" и "Продолжить". При выборе "Продолжить" система повторно проверяет уровень воды, и если он равен 0мм, люк разблокируется, если нет - сообщение об ошибке появляется снова. При выборе "Завершить" программа завершается и люк разблокируется.
ОТСУТСТВУЕТ СВЯЗЬ МЕЖДУ КАРТОЧКАМИ	Если после запуска одного из комплектов в меню SAT, в разделе «Дополнительные комплекты», отсутствует передача между карточкой главного модуля и дополнительного модуля появится настоящее предупреждение. В этом случае можно отключить, но не активировать дополнительные комплекты даже при отсутствии передачи между карточками.
ПОЛНЫЕ ЕМКОСТИ (T1/T2/T3)	Это предупреждение появляется, если какая-нибудь емкость Tx находится на этапе слива воды и обнаруживается ошибка «Макс. ур. емкости x». В этом случае слив емкости Tx прекратится и заменится на обычный слив D1. В течение 10 секунд будет активен звуковой сигнал. Это предупреждение появится после нажатия кнопки ОК, или спустя какой-то промежуток времени.
ПУСТЫЕ ЕМКОСТИ (T1/T2/T3)	Это предупреждение появляется, если какая-нибудь емкость Tx находится на этапе наполнения и обнаруживается ошибка «Миним. ур. емкости x». В этом случае наполнение емкости Tx прекратится и заменится на обычное наполнение. В течение 10 секунд будет активен звуковой сигнал. Это предупреждение появится после нажатия кнопки ОК, или спустя какой-то промежуток времени.

<p>ОТСУТСТВУЕТ СВЯЗЬ МЕЖДУ УСТРОЙСТВАМИ ВЗВЕШИВАНИЯ</p>	<p>Это предупреждение появится, если в случае активации комплекта взвешивания, или калибровки дополнительная карточка подключена и работает должным образом, однако отсутствует передача с устройством взвешивания. В этом случае не получится активировать ни комплект, ни процесс калибровки.</p>
<p>КАЛИБРОВКА ВЕСОВ — МАШИНА ПУСТАЯ</p>	<p>Это предупреждение появится в случае активации процесса калибровки комплекта взвешивания перед процессом калибровки с целью информирования пользователя о том, что машина пустая, на ней отсутствуют посторонние предметы и т.п. Отсутствует. Предупреждение информативного характера. При помощи кнопки «ОК» можно скрыть это предупреждение и приступить к процессу калибровки.</p>
<p>КАЛИБРОВКА ВЕСОВ — ОСУЩЕСТВЛЯЕТСЯ ПРОЦЕСС ВЗВЕШИВАНИЯ</p>	<p>Это предупреждение служит для информирования о выполнении процесса калибровки взвешивающего устройства. Отсутствует. Предупреждение информативного характера. Предупреждение не отключается, оно будет высвечиваться в течение 5 секунд в процессе реализации калибровки.</p>
<p>КАЛИБРОВКА ВЕСОВ — НЕКОРРЕКТНАЯ КАЛИБРОВКА</p>	<p>Это предупреждение появляется после окончания процесса калибровки, в случае если взвешивающее устройство не обнулилось. Отсутствует. Предупреждение информативного характера. При помощи кнопки «ОК» можно скрыть это предупреждение.</p>
<p>КАЛИБРОВКА ВЕСОВ — ТРЕБУЕТСЯ КАЛИБРОВКА</p>	<p>Это предупреждение появляется в случае нажатия кнопки «Пуск» для запуска той или иной программы стирки при обнаружении веса менее 3 кг и более 10 от номинального. Появятся 2 опции: «Отмена» или «ОК». При нажатии кнопки «ОК» программа будет продолжена с номинальным весом. При нажатии кнопки «Отмена» программа будет отклонена.</p>
<p>EASY LOAD — ПРИСТУПИТЬ К ПРОЦЕССУ</p>	<p>Это предупреждение появится после нажатия кнопки Easy Load в главной программе. Пользователь получит сообщение о том, что можно закладывать белье и закрывать люк, также появится возможность активировать цикл Easy Load. Появятся 2 опции: «Отмена» или «ОК». В случае нажатия кнопки «Отмена» цикл Easy Load будет отменен, а на панели появится экран с выбором программ. При нажатии кнопки «ОК» активируется цикл Easy Load.</p>
<p>EASY LOAD — ЦИКЛ В ДЕЙСТВИИ</p>	<p>Это предупреждение появится во время выполнения цикла Easy Load, информируя об этом пользователя. Предупреждение не отключается. Это предупреждение носит информативный характер, пользователь не сможет отключить его, нужно просто дождаться окончания цикла.</p>
<p>LOAD DETECTION</p>	<p>Это предупреждение появится в начале программы стирки при активированной опции умного взвешивания. Предупреждение не отключается. Это предупреждение информативного характера. Эта операция может длиться несколько минут.</p>

В ходе работы машины могут возникнуть следующие ошибки:

ОШИБКА	ОПИСАНИЕ	ПРИЧИНА И УСТРАНЕНИЕ
E1	ОБНАРУЖЕНИЕ ПРЕРЫВАНИЯ ПОДАЧИ ЭЛЕКТРОЭНЕРГИИ	Эта ошибка появится после восстановления напряжения в случае обнаружения прерывания подачи во время выполнения какой-либо программы. Программа автоматически продолжится с момента остановки, отображая предупреждающее сообщение в течение 30 секунд. Появятся две опции: «продолжить» или «завершить». Нажатие кнопки продолжить позволит продолжить выполнение программы с момента потери напряжения, но с начала той или иной фазы. Нажатие кнопки «завершить» закончит программу и разблокирует дверцы.
E2	ОШИБКА БЛОКИРОВКИ	Эта ошибка появится в начале программы, в этом случае не будет возможности заблокировать или разблокировать во время выполнения той или иной программы. Программа будет завершена, появится возможность вновь запустить ее. В этом случае необходимо удостовериться в корректности блокировки дверцы. Если ошибка не исчезает, свяжитесь с техническим сервисом.
E3	ОШИБКА СЛИВА / ВОДА В ЕМКОСТИ	Эта ошибка появится, когда стиральная машина не может выполнить слив воды из барабана. Появятся две опции: «продолжить» или «завершить». Убедитесь в отсутствии преград на выходе воды. Если машина оборудована насосом для слива, необходимо почистить его фильтр.
E4	МАКСИМАЛЬНЫЙ УРОВЕНЬ ВОДЫ	Эта ошибка появится в случае обнаружения датчиком превышающего пределы уровня воды. В режиме покоя стиральной машины удостоверьтесь, что в нее не попадает вода. В противном случае, свяжитесь с техническим сервисом.
E5	ОШИБКА ПОДАЧИ ВОДЫ	Эта ошибка появится в случае обнаружения датчиком отсутствия воды. Перед тем как обратиться в технический сервис, выполните следующее: Убедитесь, что кран подачи воды открыт. Убедитесь в правильности конфигурации слива (клапан / насос).
E6	ОШИБКА НАГРЕВАНИЯ	Эта ошибка появится в случае обнаружения датчиком некорректного нагревания воды. Перед тем как обратиться в технический сервис, убедитесь в правильности настройки нагревания воды.
E7	ПРЕВЫШЕНА МАКСИМАЛЬНАЯ ТЕМПЕРАТУРА	Эта ошибка появится в случае обнаружения повышенной температуры. В этом случае появится одна опция «завершить». Нажатие на эту кнопку завершит выполнение программы, в случае если температура превысит 50°. В противном случае появится ошибка E11: ГОРЯЧЕЕ БЕЛЬЕ
E8	ОШИБКА ПЕРЕМЕЩЕНИЯ	Эта ошибка появится в случае обнаружения датчиком отсутствия перемещения. Появится предупреждение «Программа будет завершена», и через 2 минуты появится кнопка ОК, нажав на которую программа завершится.

E9	НЕРАВНОМЕРНАЯ ЗАГРУЗКА	Эта ошибка появится в случае неспособности машины равномерно распределить белье. Попробуйте загрузить белье еще раз более равномерно.
E10	МАКСИМАЛЬНАЯ НЕРАВНОМЕРНАЯ ЗАГРУЗКА	Эта ошибка появится в случае обнаружения датчиком повышенного перемещения во время отжима. Если эта ошибка появляется периодически, обратитесь в технический сервис, так как причина может крыться в проблеме с установкой и/или амортизацией.
E11	ГОРЯЧЕЕ БЕЛЬЕ	Эта ошибка появится по завершении программы, в случае если температура внутри емкости будет превышать 50°C (122°F). Дождитесь снижения температуры ниже 50°C (122°F), после этого программа завершится автоматически.
E12	ОШИБКА РАЗБЛОКИРОВКИ	Эта ошибка появится в случае неспособности стиральной машины разблокировать дверцы после завершения программы. Она будет отображаться после 3-х попыток разблокировки каждые 20 секунд. В этом случае появится одна опция «завершить». Нажмите на нее, и вновь попробуйте открыть, в отрицательном случае ошибка не исчезнет. Не применяйте силу, чтобы открыть дверь, обратитесь в технический сервис и получите указания для безопасного открытия.
E23	ОШИБКА ВЗВЕШИВАНИЯ	Эта ошибка появится в случае обнаружения датчиком машины ошибки соединения с весами. Обратитесь в технический сервис. Появятся две опции: «ОК» и «Отмена». Нажатие на кнопку «Отмена» отменит выполнение программы, а на панели появится экран с выбором программ. Нажатие на кнопку «ОК» позволит продолжить выполнение программы со значением соответствующим номинальному весу стиральной машины.
E25	ОШИБКА ПЕРЕДАЧИ: МОДУЛЬ УПРАВЛЕНИЯ — ДОПОЛНИТЕЛЬНЫЙ	Эта ошибка появится в случае обнаружения датчиком машины ошибки соединения с дополнительной картой, используемой в различных дополнительных устройствах. Обратитесь в технический сервис. Появятся две опции: «ОК» и «Отмена». Нажатие на кнопку «Отмена» отменит выполнение программы, а на панели появится экран с выбором программ. Нажатие на кнопку «ОК» позволит продолжить выполнение программы, игнорируя функцию дополнительного устройства.
E26	ОШИБКА ДАТЧИКА ТЕМПЕРАТУРЫ ДВИГАТЕЛЯ	Эта ошибка появится в случае обнаружения датчиком повышенной температуры в двигателе. Обратитесь в технический сервис.
E27	ОШИБКА: ТЕМПЕРАТУРА ЗА ПРЕДЕЛАМИ ДОПУСКОВ	Эта ошибка появится в случае обнаружения датчиком температуры за пределами допусков. Температурный датчик, возможно, отсоединен или в неисправном состоянии. Обратитесь в технический сервис. Появятся 2 опции: «Отмена» или «ОК». Нажатие на кнопку «ОК» позволит продолжить выполнение программы, игнорируя функцию нагрева, а «Отмена» — завершит выполнения программы.
E28	ОШИБКА ДАТЧИКА ДАВЛЕНИЯ: ЗА ПРЕДЕЛАМИ ДОПУСКОВ	Эта ошибка появится в случае обнаружения датчиком уровня воды за пределами допусков. Датчик давления, возможно, отсоединен или в неисправном состоянии. Обратитесь в технический сервис. Эта ошибка не предусматривает какой-либо кнопки, ее можно устранить, выключив стиральную машину.

САМООБСЛУЖИВАНИЕ V2.0

6	ВВЕДЕНИЕ	35
7	ИНТЕРФЕЙС	35
7.1	Экран Выбора 1 — Кнопки.....	35
7.2	Экран Выбора 2 — Оплата.....	36
7.3	Кнопка возврата монет и Режим кредита	36
7.4	Рабочее окно.....	37
8	ПРОГРАММЫ	38
8.1	Библиотека программ	38
9	НАСТРОЙКИ	39
9.1	Управление программами	39
9.2	Системные настройки	39
9.2.1	Расширенные настройки	39
9.2.2	Настройка HUD	45
9.2.3	Таблица валют	47
10	ОБСЛУЖИВАНИЕ	49
10.1	Ошибки.....	49

6 ВВЕДЕНИЕ

В данном разделе приводятся исключительно характеристики стиральных машин для самообслуживания. Необходимо ознакомиться с техникой безопасности, а также прочесть остальные разделы руководства, чтобы понять принцип работы прибора.

7 ИНТЕРФЕЙС

7.1 Экран Выбора 1 — Кнопки

После подключения машины к питанию появится *Экран выбора 1*. Этот экран располагает 4 большими стационарными кнопками для выбора программ стирки.



1. **Идентификатор стиральной машины:** значок с данными о текущей конфигурации (при ее наличии).
2. **Время:** время показывается в соответствии с выбранным пользователем форматом.
3. **Название программы:** присвоенное название выбранной программе.
4. **Продолжительность программы:** продолжительность в минутах, рассчитанная для выбранной программы.
5. **Температуры программы:** максимальная температура между разными этапами, составляющими программу.
6. **Стоимость:** только в режиме Coin, в CP и CR не будет демонстрироваться стоимость, вместо нее будет гореть светодиодная лампочка.
7. **Номер программ:** Появится номер отображаемых программ, а также номер доступных программ. На экране отображается максимально 4 программы, а максимальное количество программ может составлять 16 (4 экрана с 4 кнопками на каждом).
8. **Боковые стрелки перемещения:** В случае наличия более 4-х программ в списке любимых, появятся стрелки сбоку для перемещения на следующий/предыдущий экран.

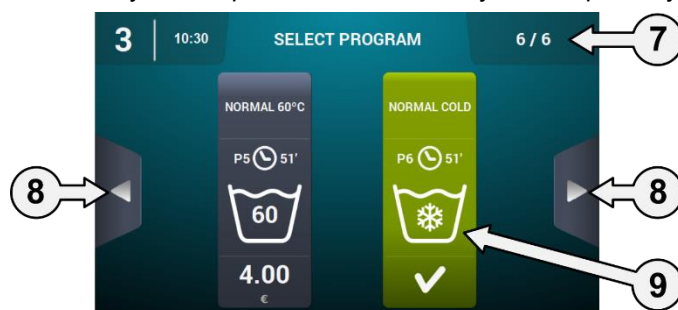

9. **Активная кнопка:** На этом первом экране можно внести оплату. Во время импорта какой-либо программы появится цена и сменится цвет кнопки, сообщая о готовности выбранной программы.

После нажатия какой-либо кнопки программы осуществится переход на «Экран выбора 2 — Оплата».

После завершения какой-либо программы снова появится этот экран.

Таким образом, даже если произошло прикосновение к экрану или был начат процесс оплаты, в случае отсутствия каких-либо действий в течение 15 минут, появится этот экран, а импорт выполненной программы будет сброшен.

7.2 Экран Выбора 2 — Оплата

На этом экране показана та же информация, что и на предыдущем, но только с данными выбранной программы с анимацией и информативным текстом. Помимо этого имеются две кнопки перемещения для смены программ.

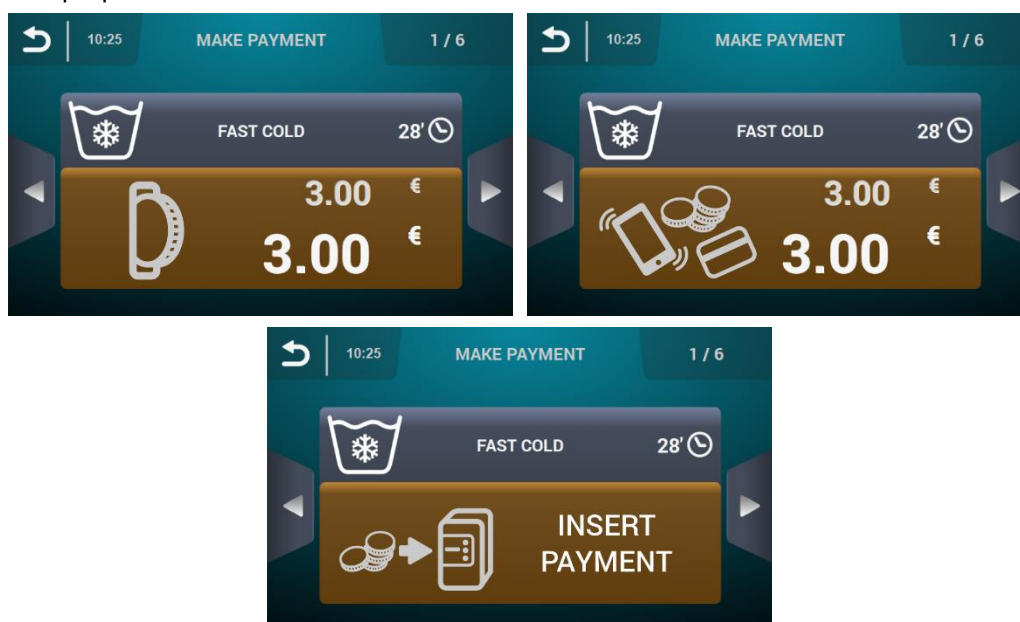

Кнопка будет отображаться коричневым цветом до упомянутого импорта программы.

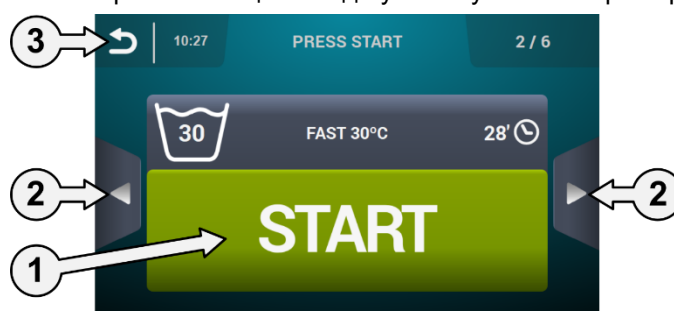

1. **Кнопка Start/Пуск:** В момент импорта программы появится большая зеленая кнопка Start/Пуск.
2. **Кнопки перемещения:** Позволяют менять программу.
3. **Кнопка назад:** Нажатие на эту кнопку позволяет вернуться на главный экран: «Выбор 1 - Кнопки».

Если спустя 15 минут не обнаруживается активность, то загруженный импорт будет сброшен, а внесенные деньги потеряны. Пользователь вернется на экран «Выбор 1 — Кнопки».

После нажатия кнопки «Пуск» начнется выполнение выбранной программы.

7.3 Кнопка возврата монет и Режим кредита

Чтобы приступить к выполнению какой-либо программы, в первую очередь необходимо внести соответствующую оплату. Для этого, в зависимости от конфигурации существующей функции самообслуживания, контролируется введение монет (режим COIN) или поступает соответствующий сигнал в режимах CP или Multipago посредством механизма монетоприемника, позволяющего выполнение выбранной программы.

Находясь в режиме самообслуживания (как на экране Выбора 1, так и на 2, во время осуществления программы самообслуживания), появится возможность входить в режим «Credit mode». В случае активации предупреждения «открытая верхняя крышка» в промышленных моделях будет либо активирован ключ для монетоприемника, либо в CP в профессиональных моделях будет запрошен пароль для входа в режим «Credit mode».

При переходе в режим кредита машина автоматически выходит из режима самообслуживания и работает как в нормальном режиме, показывая информацию Главного окна OPL с возможностью

выполнить все отображаемые на дисплее действия. На дисплее показываются программы, выбранные для режима самообслуживания и программы для режима кредита.

При переходе в главное меню, показываются все опции машин для самообслуживания.

В случае активации предупреждения «открытая верхняя крышка» в промышленных моделях будет либо удален ключ для монетоприемника, либо в СР в профессиональных моделях, будет отображаться в режим «Credit mode» автоматически. В случае нахождения на второстепенном экране главного меню (настройка, обслуживание....) и появления режима “Credit Mode”, необходимо действовать в этом режиме до перехода в главное меню (с сохранением изменений). С главного экрана можно выйти из режима “Credit Mode”.

7.4 Рабочее окно

При нажатии кнопки СТАРТ программа запускается и на дисплее появляется Рабочее окно.

Из рабочего режима можно перейти в режим кредита, как было описано выше. При переходе в режим кредита машина автоматически выходит из режима самообслуживания и работает как в режиме OPL, показывая информацию Рабочего окна OPL с возможностью выполнить все отображаемые на дисплее действия.

В режиме самообслуживания нет опций ускорения программы или установки ее на паузу; они появляются только при переходе в режим кредита.

Также, кнопка СТОП не служит, по умолчанию, для остановки программы, если только это не запрограммировано в HUD.

В случае нажатия кнопки STOP активируется период ожидания, в течение которого можно отменить выбор программы без потери внесенных денежных средств. В случае отмены программы более одного раза в период ожидания, внесенные средства будут потеряны.

По истечении периода ожидания необходимо нажать на кнопку и удерживать ее в течение 3 секунд для отмены программы. В этом случае денежные средства будут потеряны.

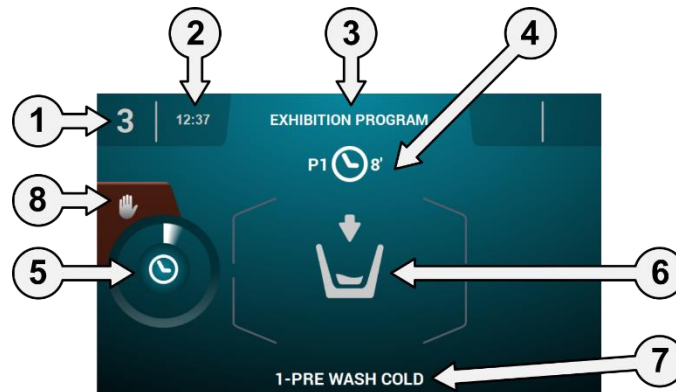

1. **Идентификация прибора:** Ярлык-идентификатор прибора
2. **Время:** Часы и минуты в выбранном формате
3. **Имя программы:** Имя, выбранное для данной программы.
4. **Номер и продолжительность программы:** Место программы в списке программ (Моипрограммы) и предположительная продолжительность выбранной программы в минутах.
5. **Индикатор выполнения программы:** Ход выполнения программы, отношение между общим временем и временем, оставшимся на выполнение программы.
6. **Состояние (схема):** Анимированная схема, иллюстрирующая текущий цикл машины (заполнение, слив, стирка, ополаскивание, отжим или распутывание).
7. **Текущий цикл:** Иконка и имя текущего цикла.
8. **Стоп:** (по умолчанию деактивирован) Кнопка для остановки и отмены программы. На дисплей выведется запрос о подтверждении.

8 ПРОГРАММЫ

Библиотека программ содержит программы, установленные по умолчанию и созданные пользователем.

8.1 Библиотека программ

В библиотеку внесено несколько программ по умолчанию:

P1: Быстрая стирка в холодной воде

P2: Быстрая стирка при 30°C (86°F)

P3: Быстрая стирка при (140°F)

P4: Быстрая стирка деликатных изделий

P1					
	8	2	2	2	6
	1	3	3	3	
	3	3	3	3	4
	0	0	0	0	
	15;05	15;05	15;05	15;05	
	✓	✓	✓	✓	
	✓	✓	✓	✓	
	✓	✓	✓	✓	
					✓
					✓
D	D2, D3			D4, D5	

P2					
	8	2	2	2	6
	30				
	1	3	3	3	
	3	3	3	3	4
	1	0	0	0	
	15;05	15;05	15;05	15;05	
	✓	✓	✓	✓	
	✓	✓	✓	✓	
	✓	✓	✓	✓	
					✓
					✓
D	D2, D3			D4, D5	

P3					
	8	2	2	2	6
	60				
	1	3	3	3	
	3	3	3	3	4
	1	0	0	0	
	15;05	15;05	15;05	15;05	
	✓	✓	✓	✓	
	✓	✓	✓	✓	
	✓	✓	✓	✓	
					✓
					✓
D	D2, D3			D4, D5	

P4					
	8	2	2	2	6
	2	4	4	4	
	2	2	2	2	3
	0	0	0	0	
	08;06	08;06	08;06	08;06	
	✓	✓	✓	✓	
	✓	✓	✓	✓	
	✓	✓	✓	✓	
					✓
					✓
D	D2, D3			D4, D5	

9 НАСТРОЙКИ

9.1 Управление программами

В случае настройки стиральной машины в режиме самообслуживания, будут доступны первые 16 программ. Остальные будут недоступны до момента вхождения в режим "Credit Mode".







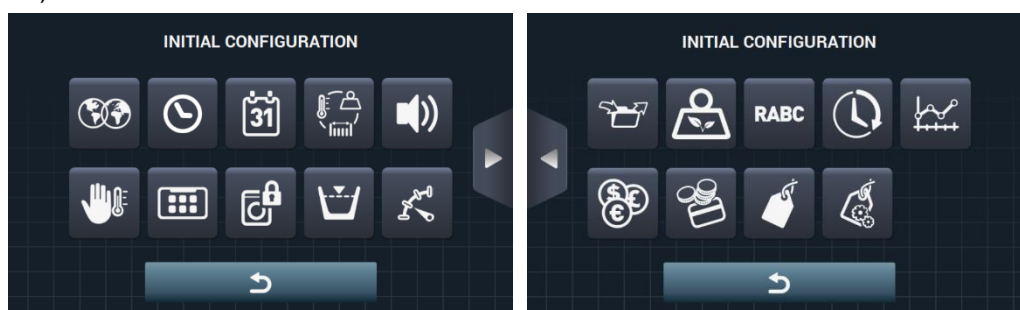

9.2 Системные настройки







9.2.1 Расширенные настройки

Доступ: [Главный экран]  ⇒ [Главное меню] 

В настройках системы можно выбрать следующие подпункты, также как и в режиме "Credit mode" (см. раздел 4.2):



-  Следующий экран.
-  Предыдущий экран.
-  **Язык:** Тексты стиральной машины могут отображаться на 34 разных языках, однако изменение текстов возможно только с использованием символов западноевропейских языков.
-  **Время:** Настройка текущего времени. Можно выбрать формат отображения (12 часовой или 24 (по умолчанию последний)).
-  **Дата:** Настройка текущей даты. Можно выбрать формат отображения даты (дд/мм/гггг (по умолчанию) / гггг/мм/дд / мм/дд/гггг).
-  **Единицы измерения:** Здесь можно выбрать единицы измерения, в которых обычно отображается температура (°C (по умолчанию, или в °F), вес (кг (по умолчанию) или в фунтах) и размер (мм (по умолчанию) или в дюймах).
-  **Термоостановка:** Можно настроить общие параметры термоостановки. В случае ее отключения, такие остановки осуществляться не будут, несмотря на активацию данного параметра в фазе. В обратном случае будут соблюдаться параметры настройки каждой фазы и соответствующее их выполнение. По умолчанию эта опция активирована.
-  **Экономия воды во время взвешивания:** Существует возможность настроить желаемую экономию воды для взвешивания при помощи 3-х разнообразных опций взвешивания и 3-х уровней экономии.
В зависимости от типа загрузки, будет осуществляться снижение того или иного уровня воды, а также дозировка моющего средства.
-  **Уровни:** Здесь имеется возможность настроить размер в мм 5 уровней. Каждый уровень будет иметь размер по умолчанию, а также параметры настройки, значения которых будут зависеть от выбранной модели. (Смотреть таблицу уровней для каждой модели).

- 
Скорость: Здесь имеется возможность настроить обороты в минуту разнообразных существующих скоростей, как для режима стирки, так и отжима. Каждая скорость будет иметь минимальное и максимальное значение. (Смотреть таблицу соотношения обороты в минуту/скорость для каждой модели).
- 
Импорт/экспорт настройки: Здесь имеется возможность импортировать с памяти USB-накопителя настройки в машину, или же наоборот, экспортировать их с памяти машины на USB-накопитель. Нажатие на эту кнопку позволяет отобразить промежуточный экран для выбора экспорта или импорта (такой же порядок, как и для программ).
- 
Режим кредита: В режиме самообслуживания можно установить пароль для режима кредита (по умолчанию 1234). Запишите пароль и сохраните записку в безопасном месте. В случае утери пароля обратитесь в службу поддержки.
- 
HUD: в режиме самообслуживания также можно настроить *Главный экран* (первый и второй экран выбора) *Экран выполнения программ*. (см.раздел 9.2.2).
- 
Звуковой сигнал: Эта опция позволяет включать или отключать звуковой сигнал. По умолчанию эта опция активирована.
- 
RABC/Отслеживание: Здесь будет регистрироваться информация о каждой стирке с сохранение данных (см. раздел 4.2.).
- 
Период ожидания: после нажатия этой кнопки появится вспомогательный экран, при помощи которого можно включать или выключать период ожидания, а также вводить его продолжительность от 1 до 99 минут (по умолчанию в настройках стоит 1 минута).

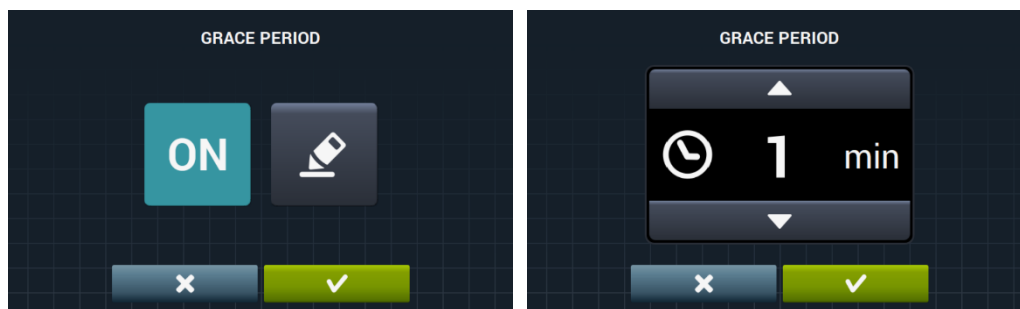

- 
Статистика самообслуживания: эта опция позволяет получать данные о внесенных денежных суммах и количестве выполнения всех любимых программ. После нажатия кнопки статистики самообслуживания, появится следующий экран.

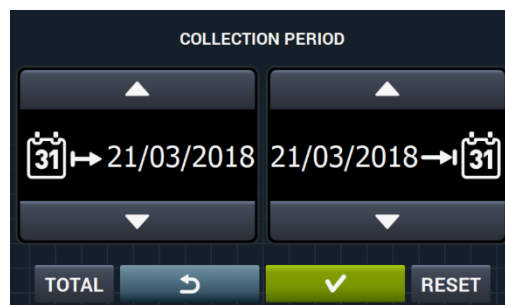

При помощи опции «TOTAL» можно получить общие значения машины. Если ввести дату, то отобразятся данные только за конкретный период времени. При помощи кнопки «Reset» можно сбросить всю статистику до 0.





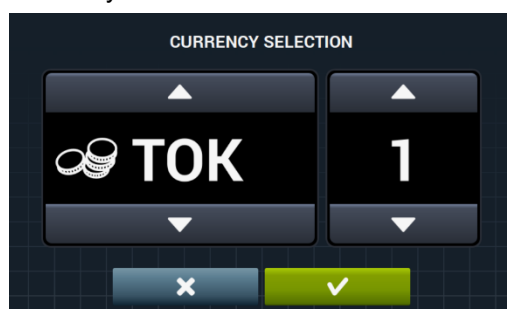

- 
Валюта: Здесь можно менять тип валюты, с которой вы хотите работать, а также менять значение каждого импульса (см. раздел 9.2.3). В случае смены валюты, все цены будут изменены соответственно. По умолчанию установлены жетоны.

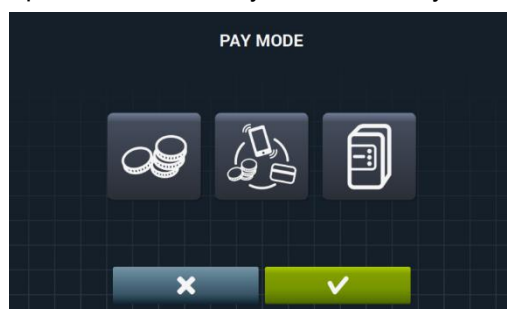

- 
Способ оплаты: В режиме самообслуживания доступны три варианта оплаты.



- 
МОНЕТЫ: Валюта и стоимость каждой программы должны быть настроены по импульсам монетоприемника, необходимым для запуска программы.
- 
Централизованная оплата (CP): Машина получает сигнал от центра оплаты на запуск программы. Задано по умолчанию. Валюта, стоимость и стоимость опций отключены.
- 
Multipago: Та же самая процедура, как и для приема монет в режиме "COIN".

- 
Стоимость: Стоимость каждой программы можно задать в разделе "Мои программы". Минимальная стоимость должна равняться указанному для конкретной валюты коэффициенту, максимальное значение должно составлять стократную величину указанного коэффициента. По умолчанию указано минимальное устанавливаемое значение.



Необходимо выбрать программу или программы, которые вы желаете изменить, нажатием на кнопку



выпадет окно, в котором вы можете установить новую цену.

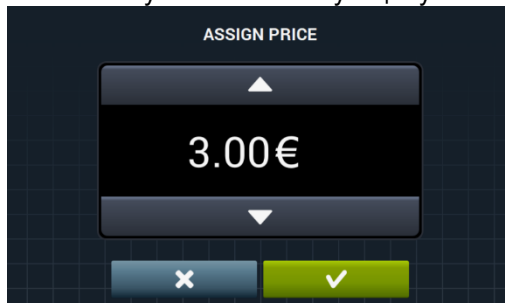

-  **Программирование стоимости:** Стоимость программы можно не просто задать, а запрограммировать. Можно указать промежутки времени, в течение которых стоимость будет изменяться. Таким образом можно изменить до 10 программ одновременно.

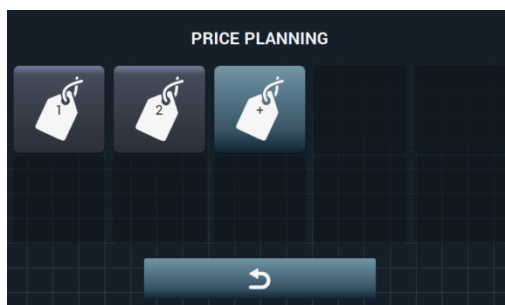

Заданная стоимость будет действительна на указанные промежутки времени. В остальное время цены примут изначально заданное значение.

В случае рассогласования значений, приоритетным будет считаться более раннее. Помимо этого, начиная с текущей даты, можно создать план.

После нажатия на кнопку  будет создан новый план. Обязательные для заполнения поля во время настройки:

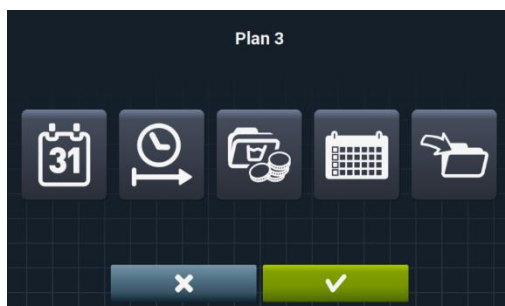

-  **Дата:** Промежуток времени, за который нужно выполнить программирование.

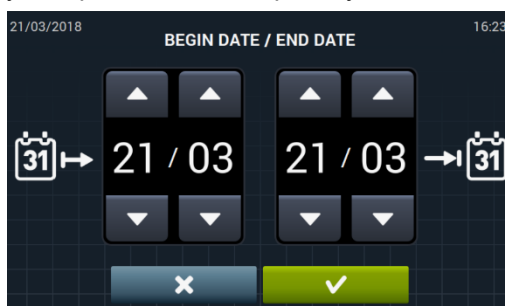

- 
Время начала/окончания: Время начала и завершения программирования.

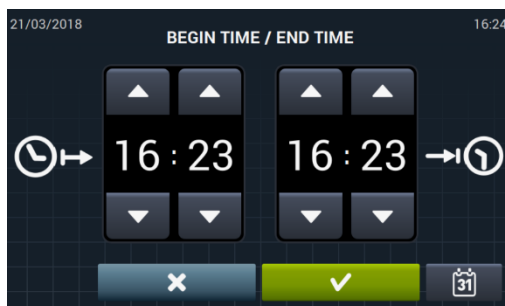

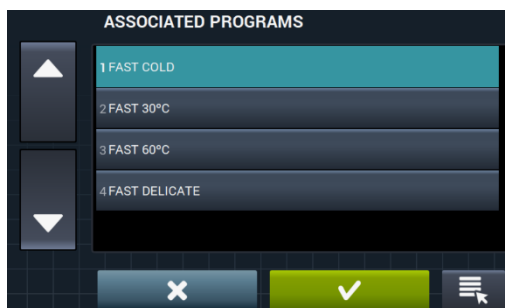

- 
Программа/-ы и стоимость: Стоимость и скидки будут приписаны к каждой существующей программе в "Моих программах". К выбранным программам будет прикреплена заданная цена или применена скидка.

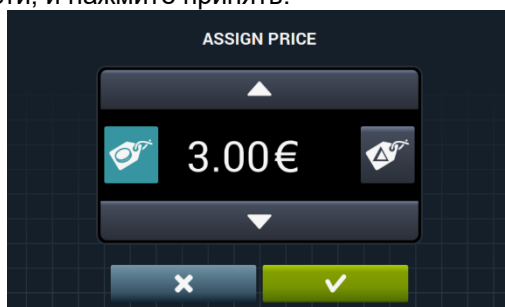

С этой целью необходимо выбрать программу или программы, в которые вы хотите внести изменения стоимости, и нажмите принять.



- 
Фиксированная цена: Во всех выбранных программах будет применена фиксированная цена.
- 
Скидка: Во всех выбранных программах будет применена определенная скидка.
- 
Календарь: Указание дней, в которые будет применяться заданное изменение цен.

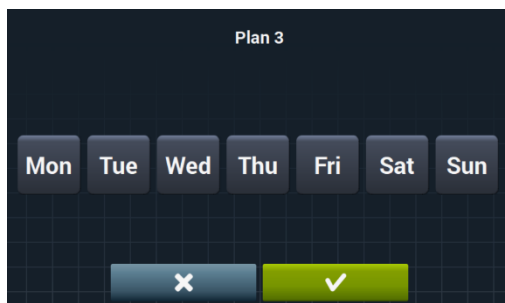

- 
Импорт: Вместо заполнения полей, можно импортировать имеющийся план с USB - устройства.

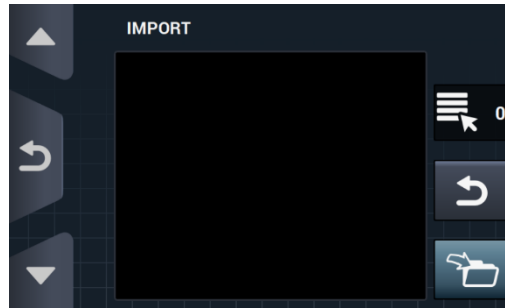

При выборе ИМПОРТА появится окно, аналогичное окну программирования, через которое можно просматривать содержимое USB-устройства, но выбрать можно только файлы с планом (расширение .plan). Можно импортировать только один файл одновременно. При нажатии ОК после импорта, на дисплей возвращается главное окно с планами стоимости.

Нажатие кнопки в одном из активных планов , отобразит итог всех настроенных параметров.

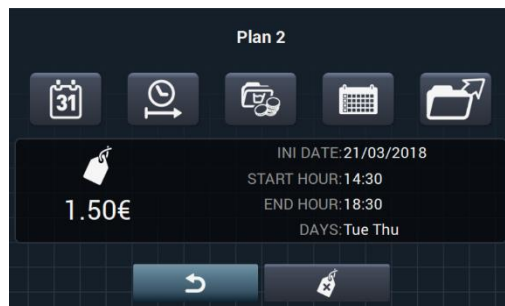

Вышеописанные параметры могут быть изменены при нажатии соответствующей кнопки. Помимо этого,

существует кнопка "Экспорт"  для экспортирования плана (файла с расширением .plan) в корневую папку USB-носителя.

Файлы с планами стоимости будут сохраняться в папке под названием «PRICE PLANS» в корневой папке USB носителя.

Каждому файлу планов цен будет присвоено название в следующем виде: PLAN_N°_Дата_время.plan (PLAN_3_20151029_112346, к примеру).

Вы можете удалить план при помощи кнопки удалить .

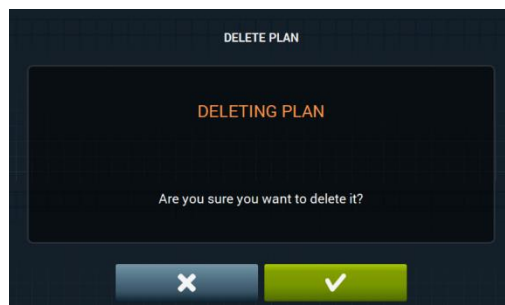

9.2.2 Настройка HUD

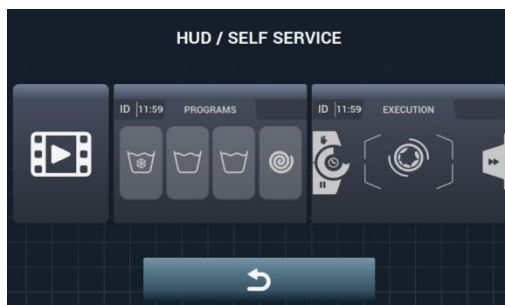



-  **Главное окно:** Применяется для обоих экранов: выбора программ и самообслуживания. Возможна настройка следующих параметров:



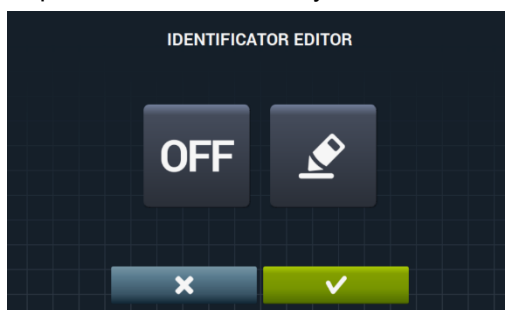

-  **Идентификация стиральной машины:** Вы можете включить/отключить и настроить идентификацию машины. По умолчанию эта опция отключена.



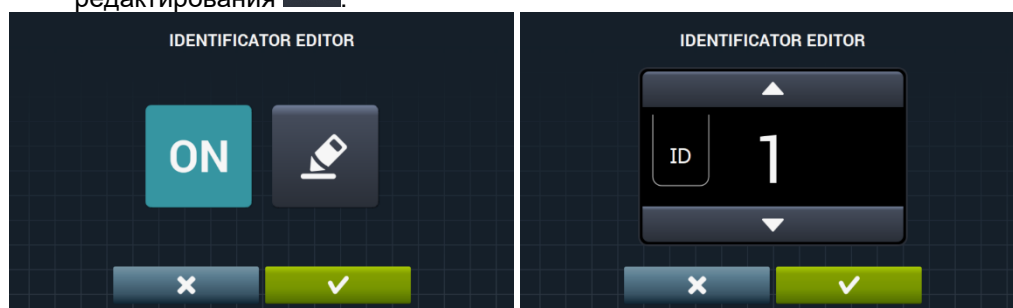



Получить такую идентификацию можно нажав на кнопку "OFF"  далее на кнопку редактирования .





-  **Время:** Отображение текущего времени. По умолчанию активно.

- 
Рабочее окно: Ниже перечислены регулируемые параметры:

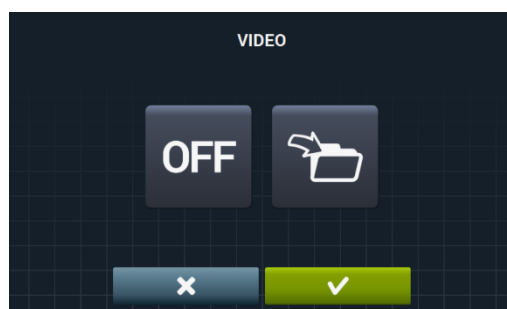

- 
Время: Отображение/скрытие времени По умолчанию активно.
 - 
Оставшееся время: Отображение/скрытие общего оставшегося времени и индикатора выполнения программы. По умолчанию активно.
 - 
Идентификатор машины: Активация/деактивация идентификатора машины. По умолчанию отключен.
 - 
Останов: Отображение кнопки останова По умолчанию отключена.
- 
Импорт видео: Эта опция позволяет воспроизводить видео на экране стиральной машины после 10 минут ее неактивного состояния. В случае активации «энергосбережения» опция воспроизведения видео отключится автоматически.



Нажатие на кнопку импорт , позволяет импортировать видео в стиральную машину с памяти внешнего USB-накопителя. В этом случае можно импортировать только видео (в формате (avi, mov,...), при этом можно иметь только одно видео в стиральной машине. Рекомендуемое разрешение для видео для машин с экраном 4,3" составляет 480x272 пикселей, а для машин с экраном 7" — 800x480. Не рекомендуется превышать кадровую частоту размером 16. Максимальный размер файла не должен превышать 25 Мб.

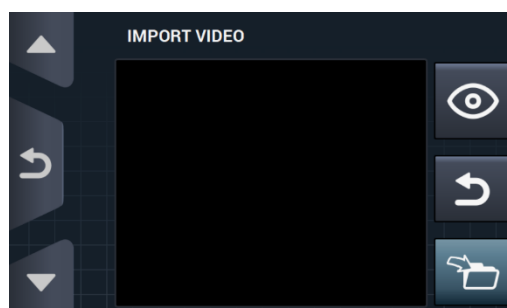

Кнопка предварительного просмотра , позволяет удостовериться в правильности воспроизведения видео.

9.2.3 Таблица валют

Ниже приводится таблица всех доступных валют с символом и коэффициентом (кратностью). Если выбрать значение импульса, отличное от значения по умолчанию, вам придется настроить монетоприемник в соответствии с выбранным значением. Это должен выполнить пользователь. По умолчанию монетоприемники поставляются с этими значениями:

ГОСУДАРСТВО	ВАЛЮТА	СИМВОЛ	ОБОЗНАЧЕНИЕ	Значение /КОЭФФИЦИЕНТ	
Символ	Символ	ТОК	\$	1	
Кувейт	Кувейтский динар	KWD	ك.د.	0,05	
Оман	Оманский риал	OMR	ر.ع.		
Азербайджан	Манат	AZN	m	0,1	
Болгария	Лев	BGN	лв		
Бахрейн	Бахрейнский динар	BHD	ب.د.		
Китай	Китайский юань	CNY	¥		
Малайзия	Малайзийский ринггит	MYR1	RM		
Панама	Панамский бальбоа	PAB	B		
Аргентина	Аргентинский песо	ARS	\$		
Бермуды	Бермудский доллар	BMD	BD\$	0,25	
Барзилия	Реал	BRL	R\$		
Канада	Канадский доллар	CAD	C\$		
Египет	Египетский фунт	EGP	ج.م.		
Эфиопия	Эфиопский быр	ETB	Br		
Гватемала	Кетсаль	GTQ	Q		
Каймановы острова	Доллар каймановых островов	KYD	\$		
Саудовская Аравия	Саудовский риал	SAR	س.ر.		
Эль Сальвадор	Сальвадорский колон	SVC	¢		
Турция	Турецкая лира	TRY	YTL		
США	Доллар США	USD	\$		
Объединенные Арабские Эмираты	Дирхам ОАЭ	AED	د.إ.		
Боливия	Боливиано	BOB	Bs		0,5
Эстония	Эстонская крона	EEK	EEK		
Страны Еврозоны	Евро	EUR	€		
Соединенное Королевство	Фунт стерлингов	GBP	£		
Грузия	Лари	GEL	ლარი		
Гана	Ганский седи	GHS	GHS		
Хорватия	Хорватская куна	HRK	kn		
Новая Зеландия	Новозеландский доллар	NZD	\$		
Катар	Катарский риал	QAR	ق.ر.		
Украина	Украинская гривна	UAH	\$		
Сингапур	Сингапурский доллар	SGD	S\$		
Малайзия	Малайзийский ринггит	MYR2	RM		
Босния и Герцеговина	Конвертируемая марка	BAM	KM		
Бангладеш	Бангладешская така	BDT	Tk	1	
Швейцария	Швейцарский франк	CHF	CHF		
Доминиканская Республика	Доминиканский песо	DOP	RD\$		
Гонконг	Гонконгский доллар	HKD	HK\$		



















Израиль	Израильский шекель	ILS	₪	
Индия	Индийская рупия	INR	Rs.	
Шри-Ланка	Шри-ланкийская рупия	LKR	₨	
Марокко	Марроканский дирхам	MAD	د.م.	
Македония	Македонский денар	MKD	MKD	
Перу	Перуанский новый соль	PEN	S/.	
Польша	Польский злотый	PLN	zł	
Российская Федерация	Российский рубль	RUB	руб	
Швеция	Шведская крона	SEK	kr	
Тайланд	Тайский бат	THB	฿	
Тунис	Тунисский динар	TND	ت.د.	
Уругвай	Уругвайский песо	UYU	\$	
Сербия	Сербский динар	RSD	дин.	
ЮАР	Южноафриканский рэнд	ZAR	R	
Австралия	Австралийский доллар	AUD	\$	
Чешская Республика	Чешская крона	CZK	Kč	
Дания	Датская крона	DKK	kr	
Кения	Кенийский шиллинг	KES	KSh	
Мексика	Мексиканский песо	MXN	\$	
Норвегия	Норвежская крона	NOK	kr	
Румыния	Румынский лей	RON	L	
Филиппины	Филиппинский песо	PHP	\$	
Алжир	Алжирский динар	DZD	د.ج.	
Гайана	Гайанский доллар	GYD	GY\$	10
Венгрия	Венгерский форинт	HUF	Ft	
Исландия	Исландская крона	ISK	kr	
Казахстан	Казахский тенге	KZT	T	
Тайвань	Тайваньский доллар	TWD	NT\$	
Чили	Чилийский песо	CLP	\$	
Коста Рика	Костариканский колон	CRC	₡	50
Иран	Иранский риал	IRR		
Парагвай	Парагвайский гуарани	PYG	\$	
Французская Полинезия	Французский Тихоокеанский франк	XPF	F	
Колумбия	Колумбийский песо	COP	\$	100
Индонезия	Индонезийская рупия	IDR	Rp	
Япония	Японская йена	JPY	¥	
Южная Корея	Корейская вона	KRW	₩	
Уганда	Угандийский шиллинг	UGX	USh	
Венесуэла	Венесуэльский боливар	VEF	Bs.	



















10 ОБСЛУЖИВАНИЕ





















10.1 Ошибки



















Ниже приведен список ошибок, возникающих в режиме самообслуживания, и действий по их устранению. Остальные неполадки аналогичны возникающим в нормальном режиме эксплуатации.











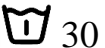







ОШИБКА	ОПИСАНИЕ	ПРИЧИНА И УСТРАНЕНИЕ
E6	ОШИБКА НАГРЕВА	Датчик получит информацию, несмотря на активацию выхода из режима нагревания, что температура воды не повышается в течение 30 минут. Данную ошибку можно пропустить. В этом случае, вместо вывода сообщения об ошибке, машина продолжит работать, как если бы заданная температура была достигнута. На дисплей выводится предупреждение, но машина не останавливается. Работа машины продолжается, но предупредительное сообщение остается на дисплее до завершения программы и разблокировки люка.
E9	ДИСБАЛАНС	В ходе распределения перед финальным отжимом вход "Датчик дисбаланса" активируется 5 раз. Ошибка не срабатывает, и отжим продолжается при низкой скорости. Программа завершается в нормальном режиме, без вывода предупреждений











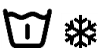







P1	 40	 90	 1	 2		 3	
	6	15	3	3	2	3	6
	40	90					
	1	1	3	3		3	
	3	3	3	3	3	3	4
	1	1	0	0		0	
	15;05	15;05	15;05	15;05		15;05	
	✓	✓	✓	✓		✓	
		✓					
	✓	✓	✓	✓		✓	
	✓	✓	✓	✓		✓	
					✓		✓
							✓
D	D1	D2, D3				D4, D5	



















P2	 30	 60	 1	 2		 3	
	6	15	3	3	2	3	6
	30	60					
	1	1	3	3		3	
	3	3	3	3	3	3	4
	1	1	0	0		0	
	15;05	15;05	15;05	15;05		15;05	
	✓	✓	✓	✓		✓	
		✓					
	✓	✓	✓	✓		✓	
	✓	✓	✓	✓		✓	
					✓		✓
							✓
D	D1	D2, D3				D4, D5	







P3	 	 30	 1	 2		 3	
	6	15	3	3	2	3	6
		30					
	1	1	3	3		3	
	3	3	3	3	3	3	4
	0	1	0	0		0	
	15;05	15;05	15;05	15;05		15;05	
	✓	✓	✓	✓		✓	
		✓					
	✓	✓	✓	✓		✓	
	✓	✓	✓	✓		✓	
					✓		✓
							✓
D	D1	D2, D3				D4, D5	







P4							
	6	15	3	3	2	3	6
							
	1	1	3	3		3	
	3	3	3	3	3	3	4
	0	0	0	0		0	
	15;05	15;05	15;05	15;05		15;05	
	✓	✓	✓	✓		✓	
							
	✓	✓	✓	✓		✓	
	✓	✓	✓	✓		✓	
					✓		✓
							✓
D	D1	D2, D3				D4, D5	

P5							
	6	15	3	3	2	3	6
	30	60					
	2	2	4	4		4	
	3	3	3	3	3	3	4
	1	1	0	0		0	
	15;05	15;05	15;05	15;05		15;05	
	✓	✓	✓	✓		✓	
		✓					
	✓	✓	✓	✓		✓	
	✓	✓	✓	✓		✓	
					✓		✓
							✓
D	D1	D2, D3				D4, D5	

P6							
	6	15	3	3	2	3	6
		30					
	2	2	4	4		4	
	3	3	3	3	3	3	4
	0	1	0	0		0	
	15;05	15;05	15;05	15;05		15;05	
	✓	✓	✓	✓		✓	
		✓					
	✓	✓	✓	✓		✓	
	✓	✓	✓	✓		✓	
					✓		✓
							✓
D	D1	D2, D3				D4, D5	

P7							
	6	15	3	3	2	3	6
							
	2	2	4	4		4	
	3	3	3	3	3	3	4
	0	0	0	0		0	
	15;05	15;05	15;05	15;05		15;05	
	✓	✓	✓	✓		✓	
							
	✓	✓	✓	✓		✓	
	✓	✓	✓	✓		✓	
					✓		✓
							✓
D	D1	D2, D3				D4, D5	

P8						
	6	12	3	3	3	6
		40				
	2	2	4	4	4	
	2	2	2	2	2	3
	0	1	0	0	0	
	15;08	15;08	15;08	15;08	15;08	
						
		✓				
						
	✓	✓	✓	✓	✓	
						✓
						✓
D	D1	D2			D4, D5	

P9						
	6	10	3	3	3	4
						
	3	3	4	4	4	
	2	2	2	2	2	3
	0	0	0	0	0	
	15;08	15;08	15;08	15;08	15;08	
						
						
						
	✓	✓	✓	✓	✓	
						✓
						✓
D	D1	D2			D4, D5	



P10					
	12	3	3	3	3
	1	4	4	4	
	2	2	2	2	2
	0	0	0	0	
	05;15	05;15	05;15	05;15	
	✓	✓	✓	✓	
					✓
					✓
D	D2			D4, D5	





P11					
	15	3	2	3	6
	90				
	1	3		3	
	3	3	3	3	4
	1	0		0	
	15;05	15;05		15;05	
	✓	✓		✓	
	✓				
	✓	✓		✓	
	✓	✓		✓	
			✓		✓
					✓
D	D2, D3			D4, D5	





P12					
	15	3	2	3	6
	60				
	1	3		3	
	3	3	3	3	4
	1	0		0	
	15;05	15;05		15;05	
	✓	✓		✓	
	✓				
	✓	✓		✓	
	✓	✓		✓	
			✓		✓
					✓
D	D2, D3			D4, D5	

P13					
	15	3	2	3	6
	30				
	1	3		3	
	3	3	3	3	4
	1	0		0	
	15;05	15;05		15;05	
	✓	✓		✓	
	✓				
	✓	✓		✓	
	✓	✓		✓	
			✓		✓
					✓
D	D2, D3			D4, D5	

P14					
	15	3	2	3	6
	1	3		3	
	3	3	3	3	4
	0	0		0	
	15;05	15;05		15;05	
	✓	✓		✓	
	✓	✓		✓	
	✓	✓		✓	
			✓		✓
					✓
D	D2, D3			D4, D5	

P15		 65	 71	 1		 2		 3	
	3	6	15	3	2	3	2	3	6
		65	71						
	3	1	1	3		3		3	
	3	3	3	3	3	3	3	3	4
	0	1	1	0		0		0	
	15;05	15;05	15;05	15;05		15;05		15;05	
	✓	✓	✓	✓		✓		✓	
			✓						
	✓	✓	✓	✓		✓		✓	
	✓	✓	✓	✓		✓		✓	
					✓		✓		✓
									✓
D		D1	D2, D3					D4, D5	

P16	
	6
	4
	✓
	✓

P17	
	2
	2
	✓
	✓